

HERS WARDROBE

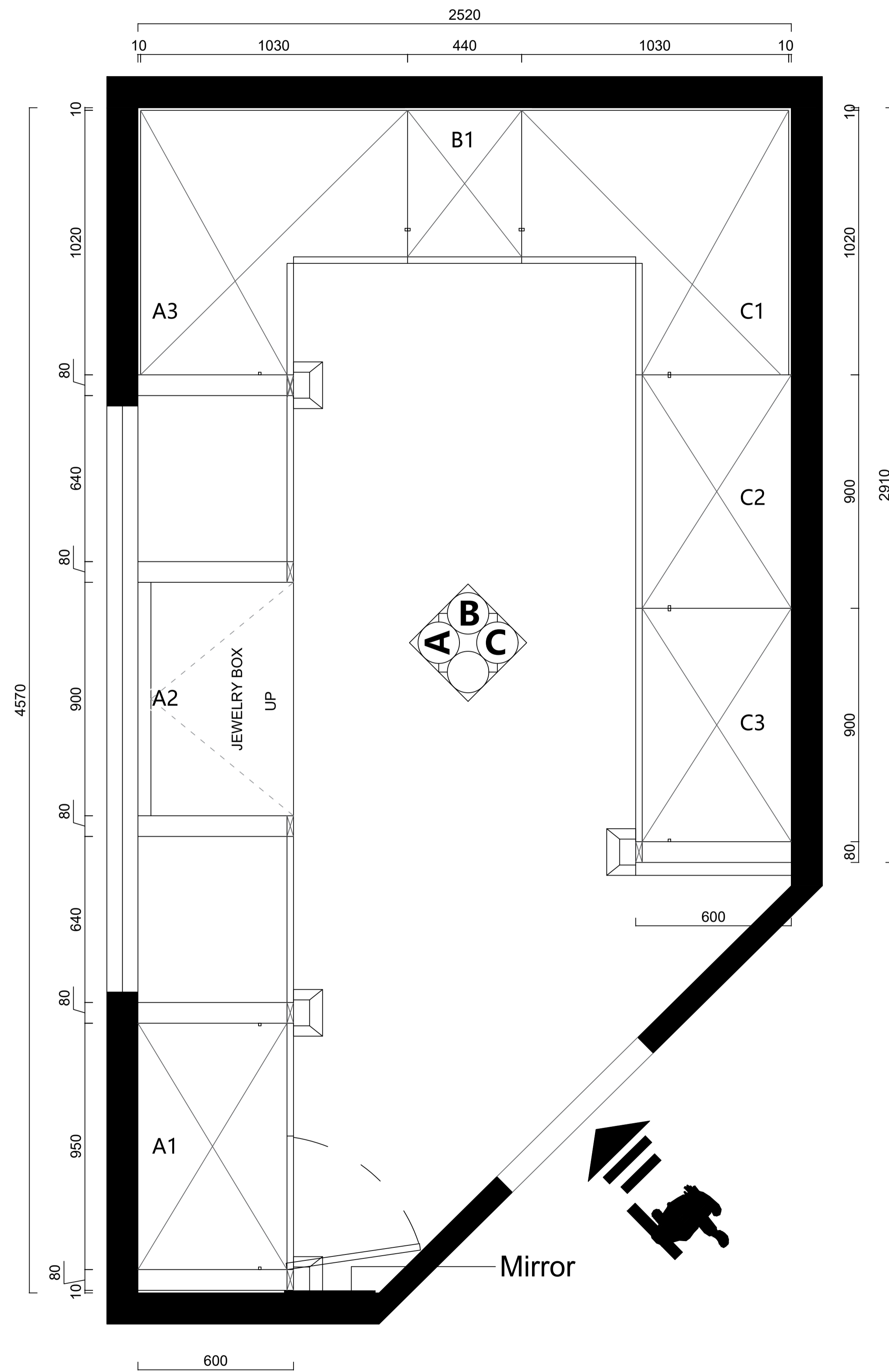

Order No: WMAU241130001

Client Name: Rashid

Email:

Client Address: Australia

Room Space: HERS

Carcass Material MFC E0 18MM DY1058

Door Material HDF E0 18MM Painted/White

Door Shape

Drawer Handle:

Door Handle:

Remark:

Design Date:

Lead Time: 10-12 Weeks

Consignee:
Date:

Designer:
Tel:

HERS WARDROBE

WAYMOVE

Order No: WMAU241130001

Client Name: Rashid

Email:

Client Address: Australia

Room Space: HERS

Carcass MFC E0 18MM

Material DY1058

Door HDF E0 18MM

Material Painted/White

Door Shape

Shape

Drawer Handle:

Door Handle:

Remark:

Design Date:

Lead Time: 10-12 Weeks

Consignee:

Date:

Designer:

Tel:

Pages

19/2

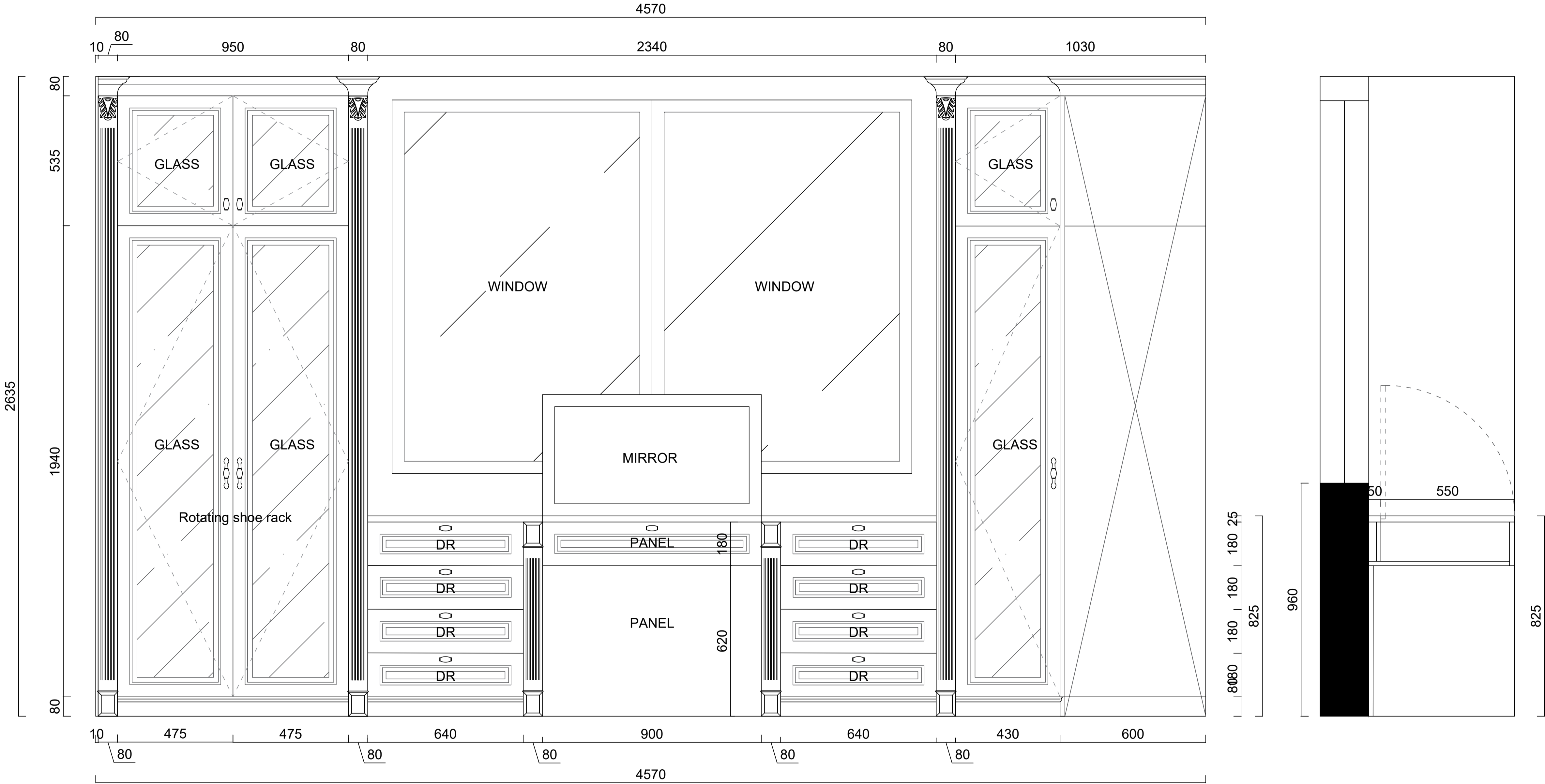

A ELEVATION

HERS WARDROBE

WAYMOVE

Order No: WMAU241130001

Client Name: Rashid

Email:

Client Address: Australia

Room Space: HERS

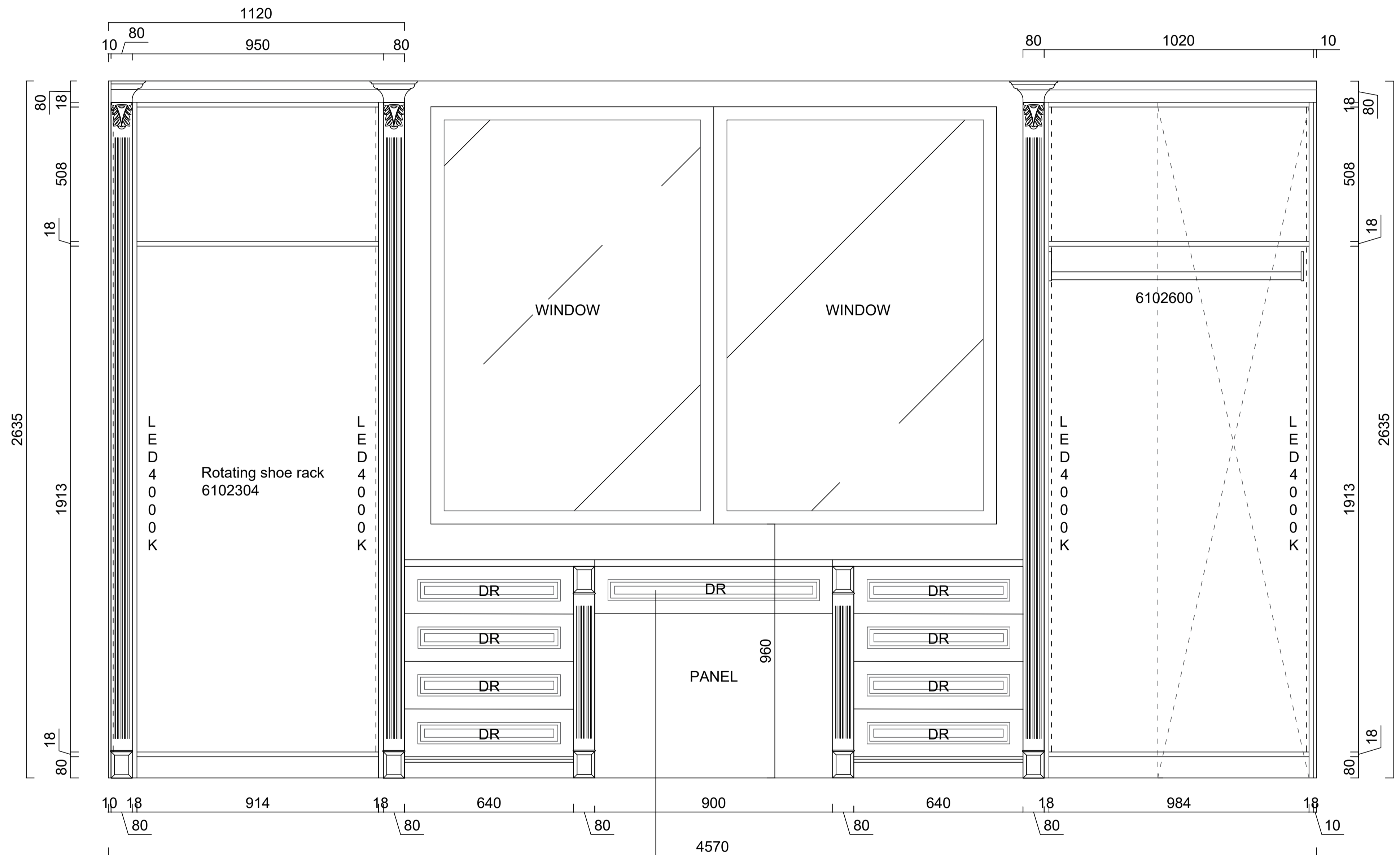

A STRUCTURE

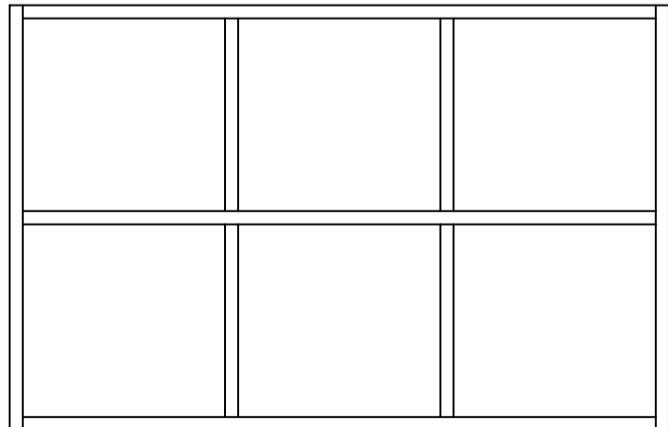

Carcass Material	<input type="checkbox"/> MFC E0 18MM
	<input checked="" type="checkbox"/> DY1058
Door Material	<input type="checkbox"/> HDF E0 18MM
	<input checked="" type="checkbox"/> Painted/White
Door Shape	<input checked="" type="checkbox"/> [Cross-hatch pattern]
	<input type="checkbox"/> [Empty square]

Drawer Handle:

Door Handle:

Remark:

Design Date:

Lead Time: 10-12 Weeks

Consignee:

Date:

Designer:

Tel:

HERS WARDROBE

WAYMOVE

Order No: WMAU241130001

Client Name: Rashid



Email:

Client Address: Australia

Room Space: HERS

Carcass Material MFC E0 18MM
 DY1058

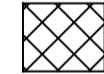
Door Material HDF E0 18MM
 Painted/White

Door Shape 
 

Drawer Handle:

Door Handle:

Remark:

Design Date:

Lead Time: 10-12 Weeks

Consignee:

Date:

Designer:

Tel:

Pages 19/4

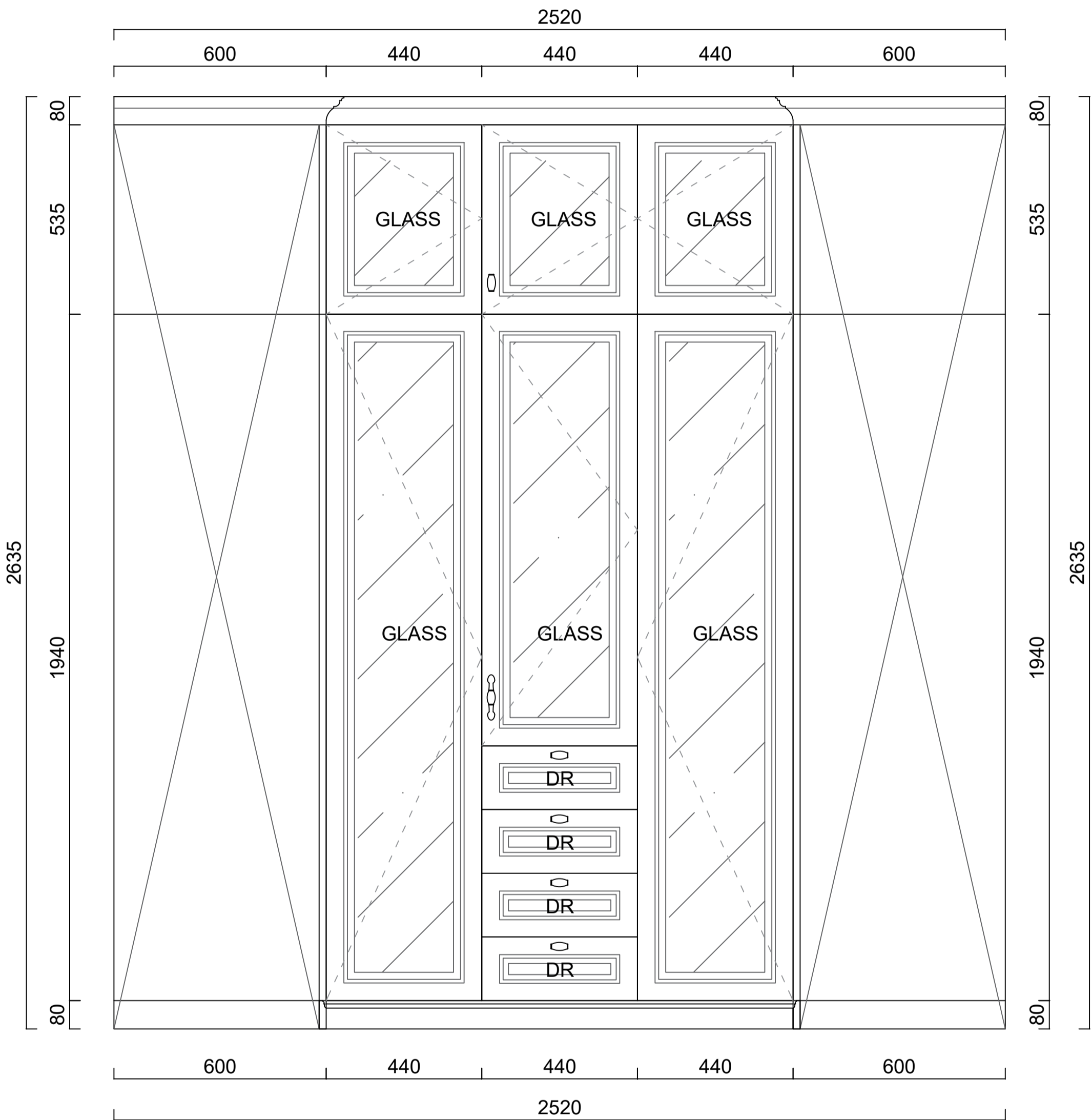

B ELEVATION

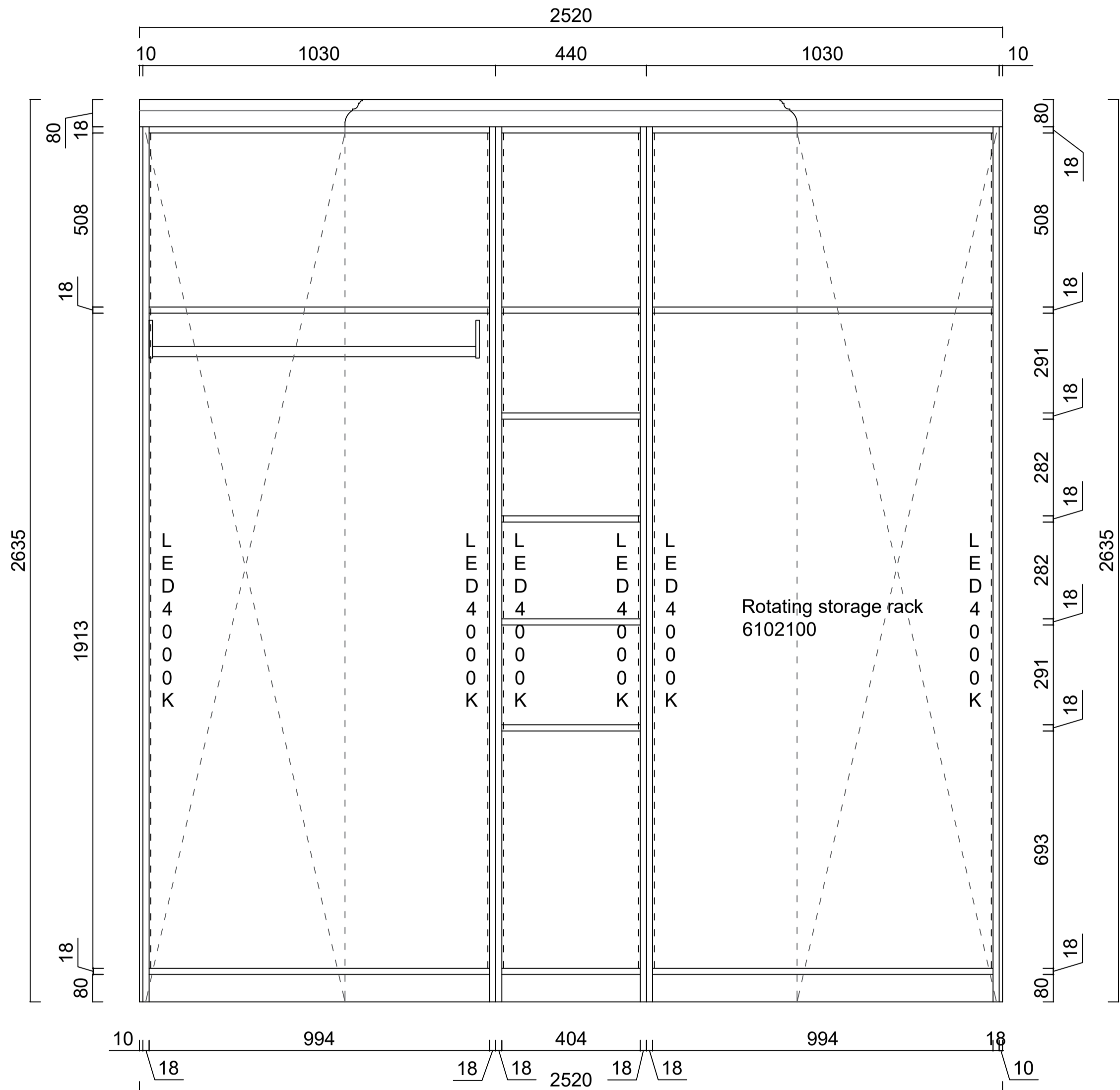

B STRUCTURE

HERS WARDROBE

WAYMOVE



Order No: WMAU241130001

Client Name: Rashid

Email:

Client Address: Australia

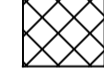
Room Space: HERS

Carcass Material	<input type="checkbox"/> MFC E0 18MM
	<input checked="" type="checkbox"/> DY1058
Door Material	<input type="checkbox"/> HDF E0 18MM
	<input checked="" type="checkbox"/> Painted/White
Door Shape	<input checked="" type="checkbox"/> 
	<input type="checkbox"/> 

Drawer Handle:

Door Handle:

Remark:

Design Date:

Lead Time: 10-12 Weeks

Consignee:

Date:

Designer:

Tel:

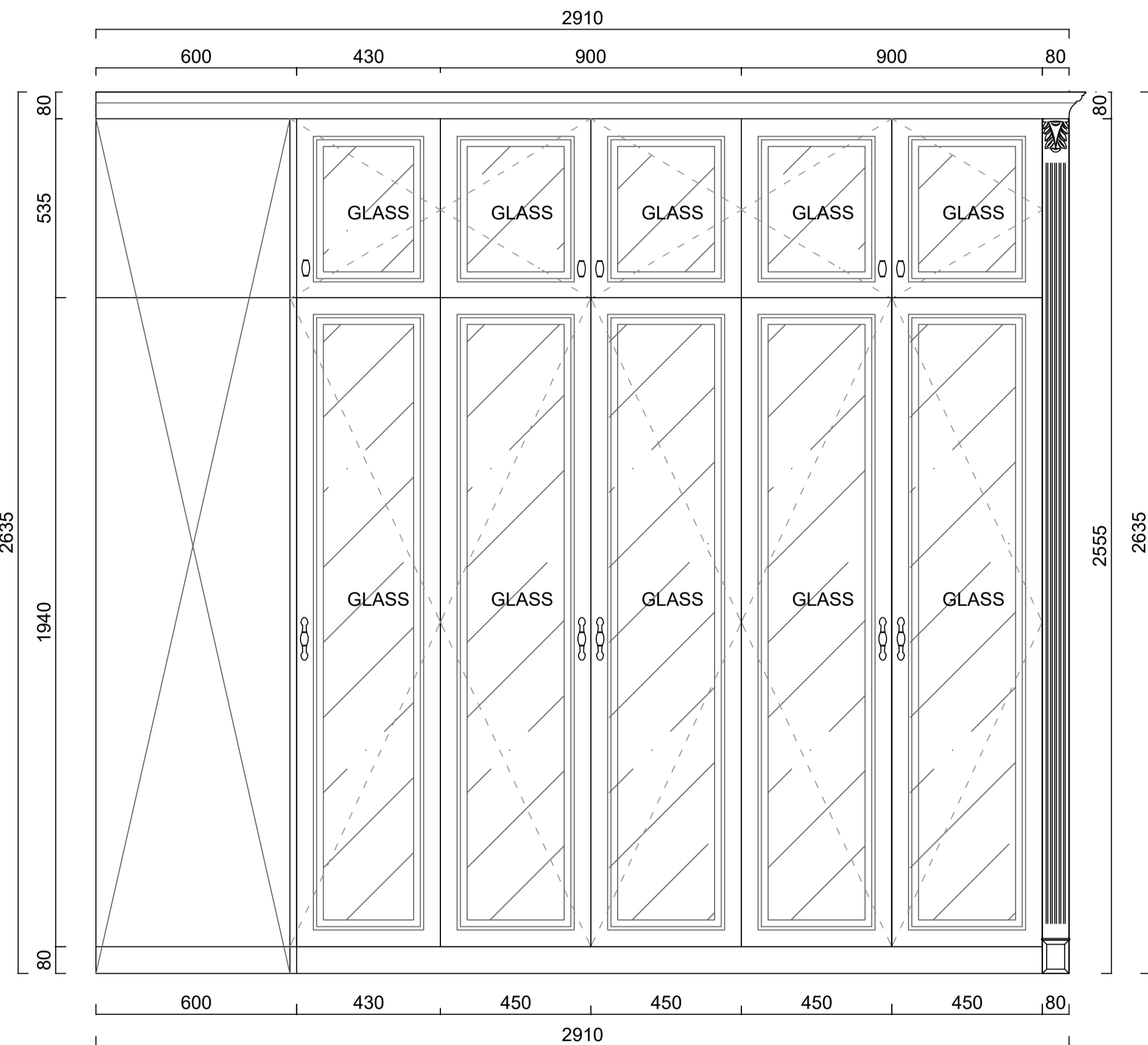

C ELEVATION

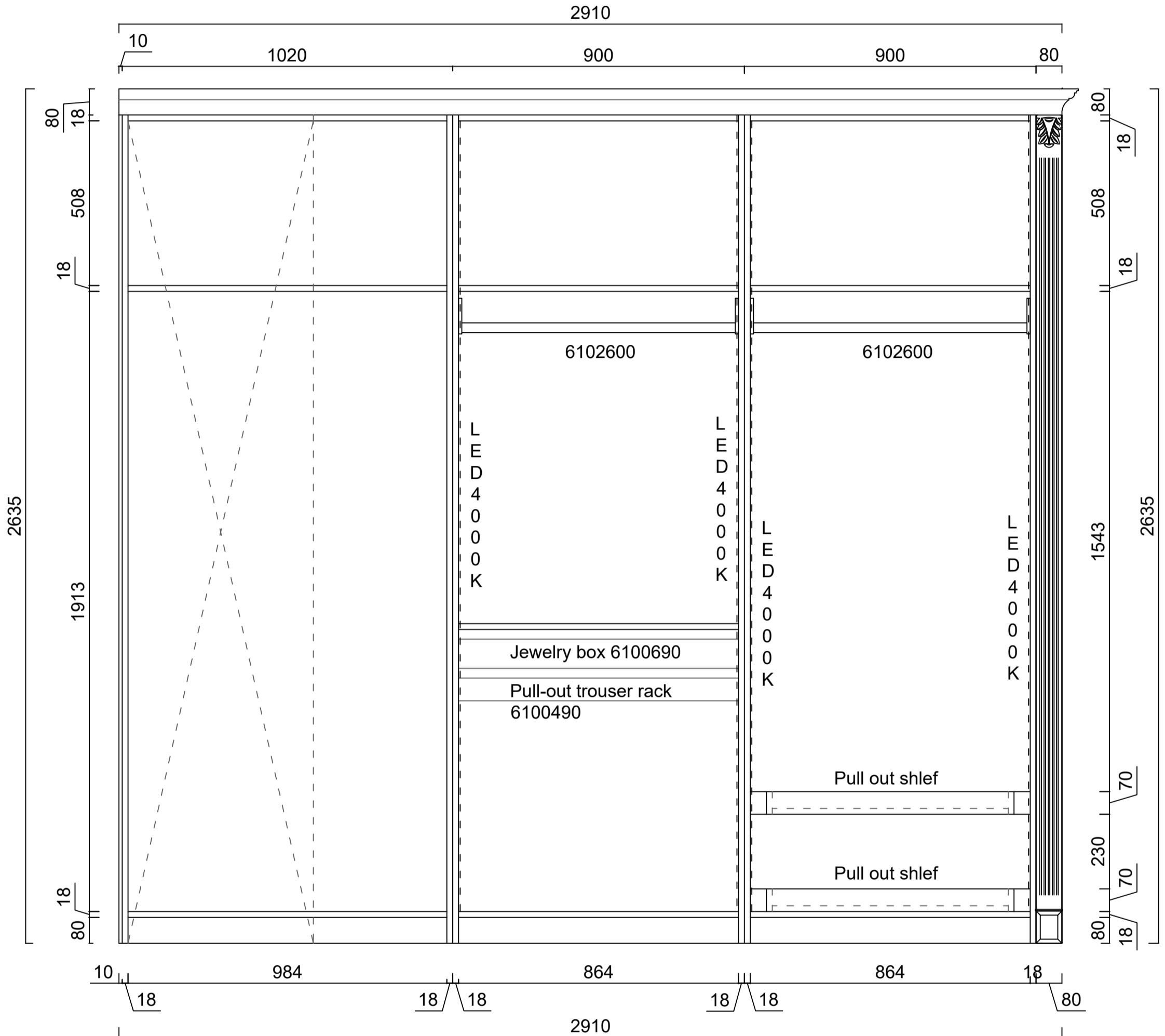

C STRUCTURE

HERS WARDROBE

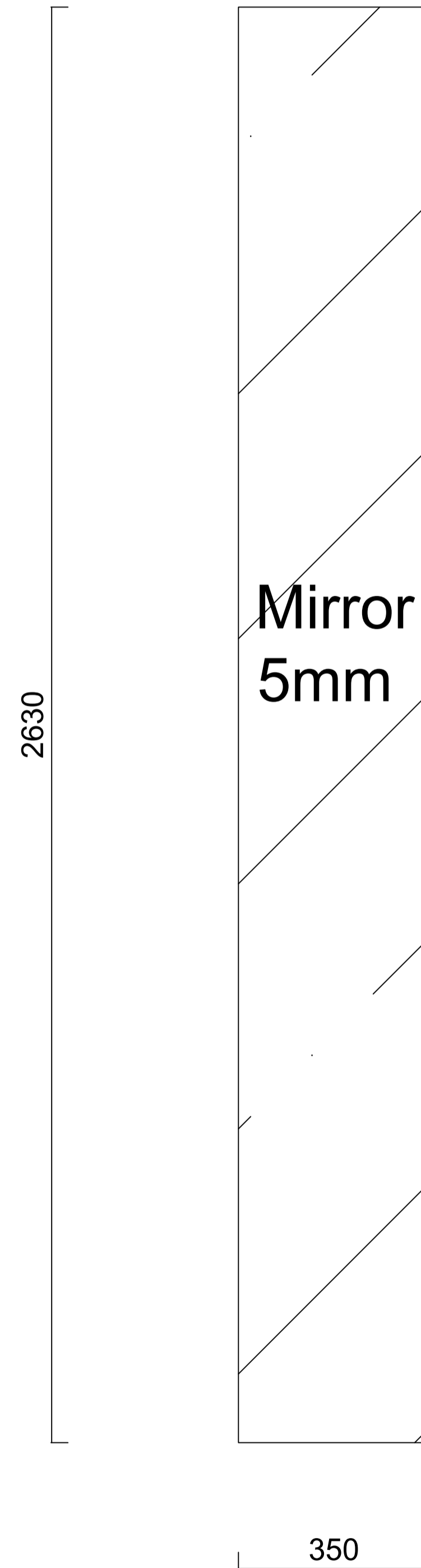

Order No: WMAU241130001

Client Name: Rashid

Email:

Client Address: Australia

Room Space: HERS

Carcass Material	<input type="checkbox"/> MFC E0 18MM
	<input checked="" type="checkbox"/> DY1058

Door Material	<input type="checkbox"/> HDF E0 18MM
	<input checked="" type="checkbox"/> Painted/White

Door Shape	<input checked="" type="checkbox"/>
	<input type="checkbox"/>

Drawer Handle:

Door Handle:

Remark:

Design Date:

Lead Time: 10-12 Weeks

Consignee:
Date:

Designer:
Tel:

HIS WARDROBE

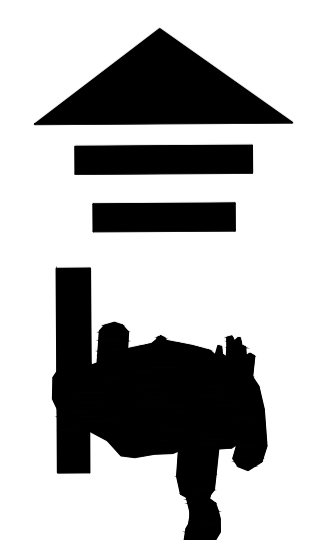
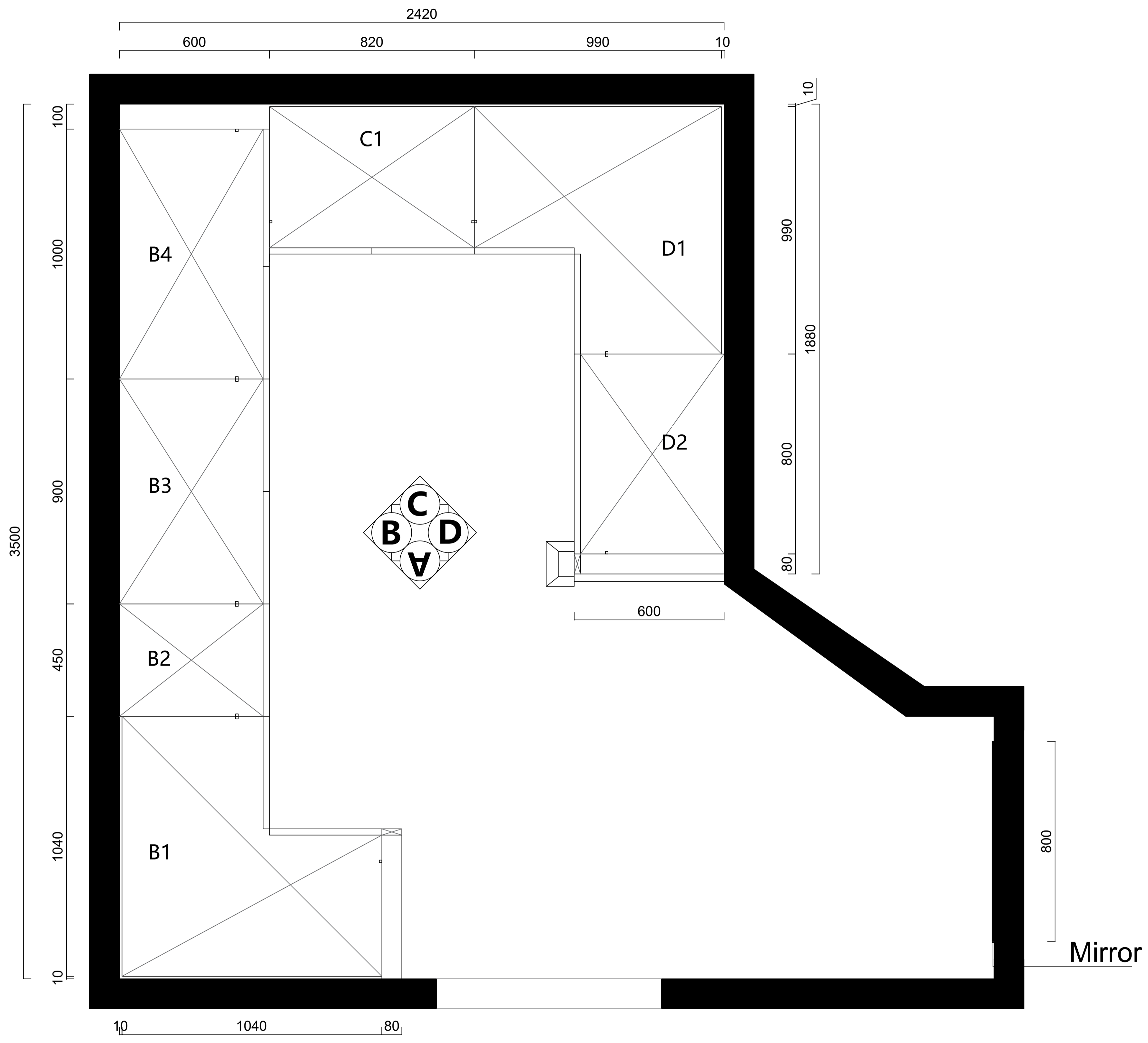

WAYMOVE
One Stop Home Solutions

Order No: WMAU241130001

Client Name: Rashid

Email:

Client Address: Australia

Room Space: HIS

Carcass Material	<input type="checkbox"/> MFC E0 18MM
	<input checked="" type="checkbox"/> JXM5014
Door Material	<input type="checkbox"/> HDF E0 18MM
	<input checked="" type="checkbox"/> Veneer
Door Shape	<input checked="" type="checkbox"/> [Cross-hatch pattern]
	<input type="checkbox"/> [Empty square]

Drawer Handle:

Door Handle:

Remark:

Design Date:

Lead Time: 10-12 Weeks

Consignee:

Date:

Designer:

Tel:

HIS WARDROBE

WAYMOVE

One Stop Home Solutions

Order No: WMAU241130001

Client Name: Rashid

Email:

Client Address: Australia

Room Space: HIS

Carcass Material MFC E0 18MM
 JXM5014

Door Material HDF E0 18MM
 Veneer

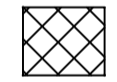
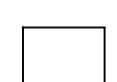
Door Shape 
 

Drawer Handle:

Door Handle:

Remark:

Design Date:

Lead Time: 10-12 Weeks

Consignee:

Date:

Designer:

Tel:

Pages 19/8

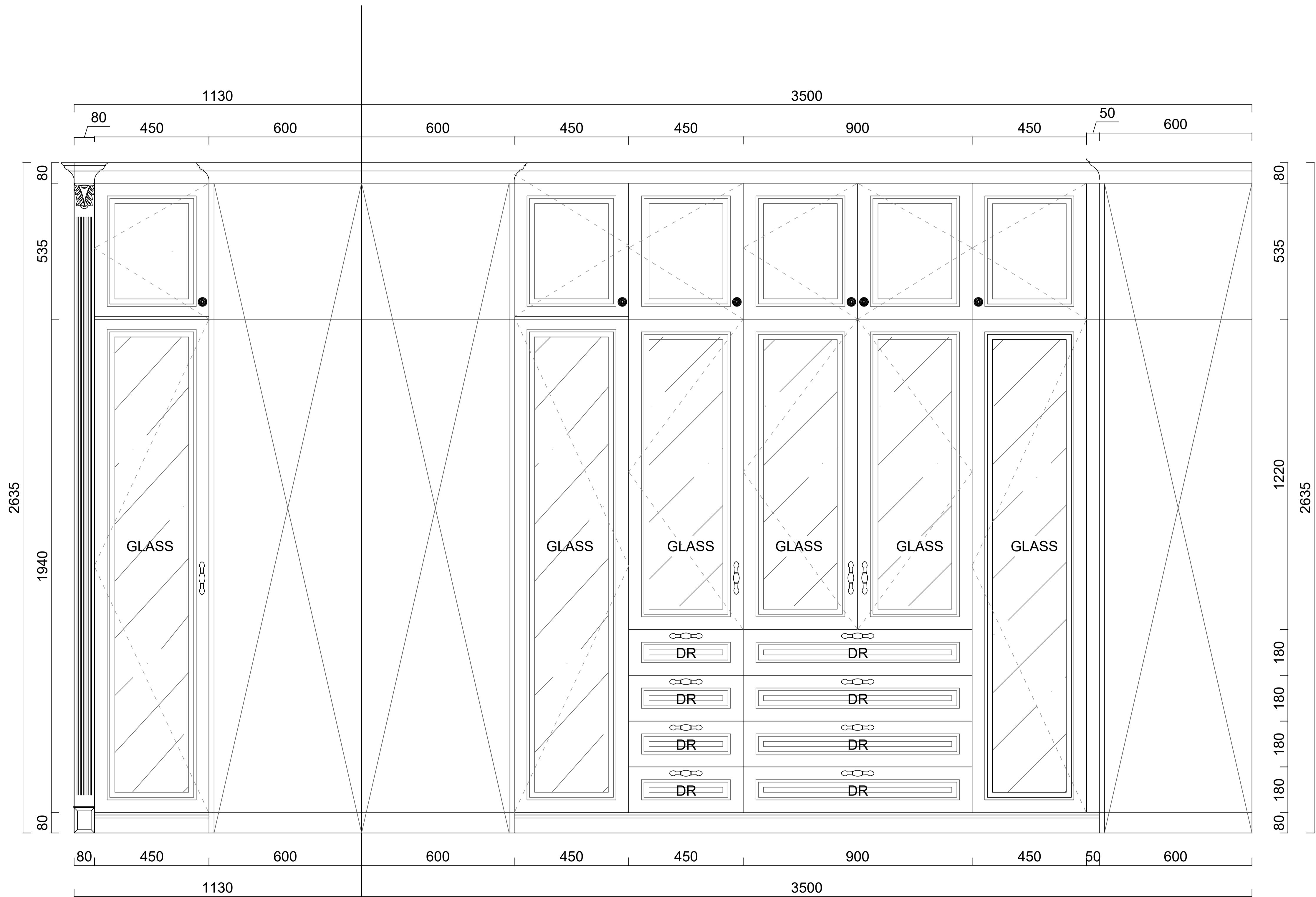

A ELEVATION

B ELEVATION

HIS WARDROBE

WAYMOVE

One Stop Home Solutions

Order No: WMAU241130001

Client Name: Rashid

Email:

Client Address: Australia

Room Space: HIS

Carcass MFC E0 18MM

Material JXM5014

Door HDF E0 18MM

Material Veneer

Door Shape

Shape

Drawer Handle:

Door Handle:

Remark:

Design Date:

Lead Time: 10-12 Weeks

Consignee:

Date:

Designer:

Tel:

Pages

19/9

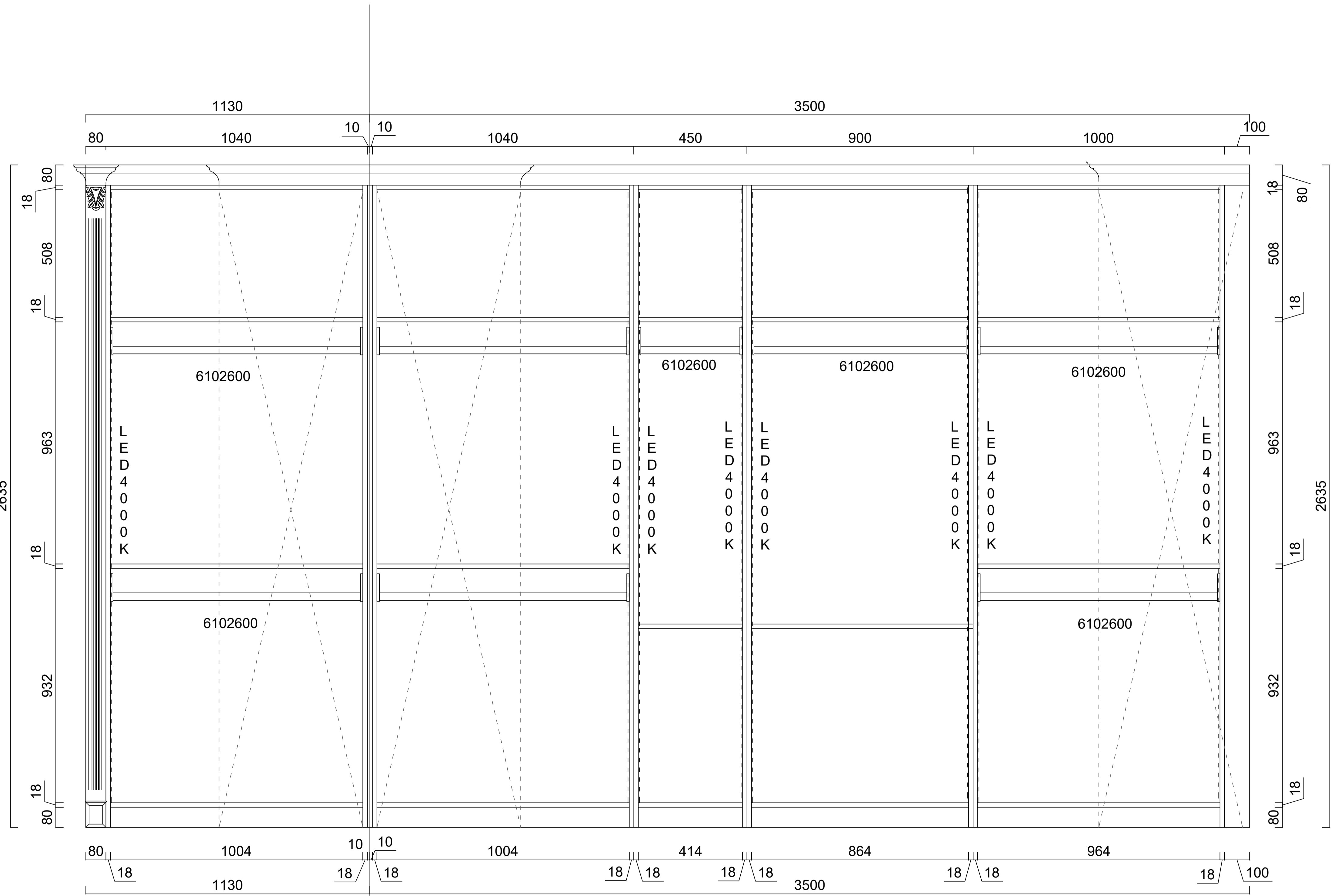

A STRUCTURE

B STRUCTURE

HIS WARDROBE

WAYMOVE
One Stop Home Solutions



Order No: WMAU241130001

Client Name: Rashid

Email:

Client Address: Australia

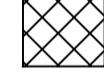
Room Space: HIS

Carcass Material	<input type="checkbox"/> MFC E0 18MM
	<input checked="" type="checkbox"/> JXM5014
Door Material	<input type="checkbox"/> HDF E0 18MM
	<input checked="" type="checkbox"/> Veneer
Door Shape	<input checked="" type="checkbox"/> 
	<input type="checkbox"/> 

Drawer Handle:

Door Handle:

Remark:

Design Date:

Lead Time: 10-12 Weeks

Consignee:

Date:

Designer:

Tel:

Pages 19/10

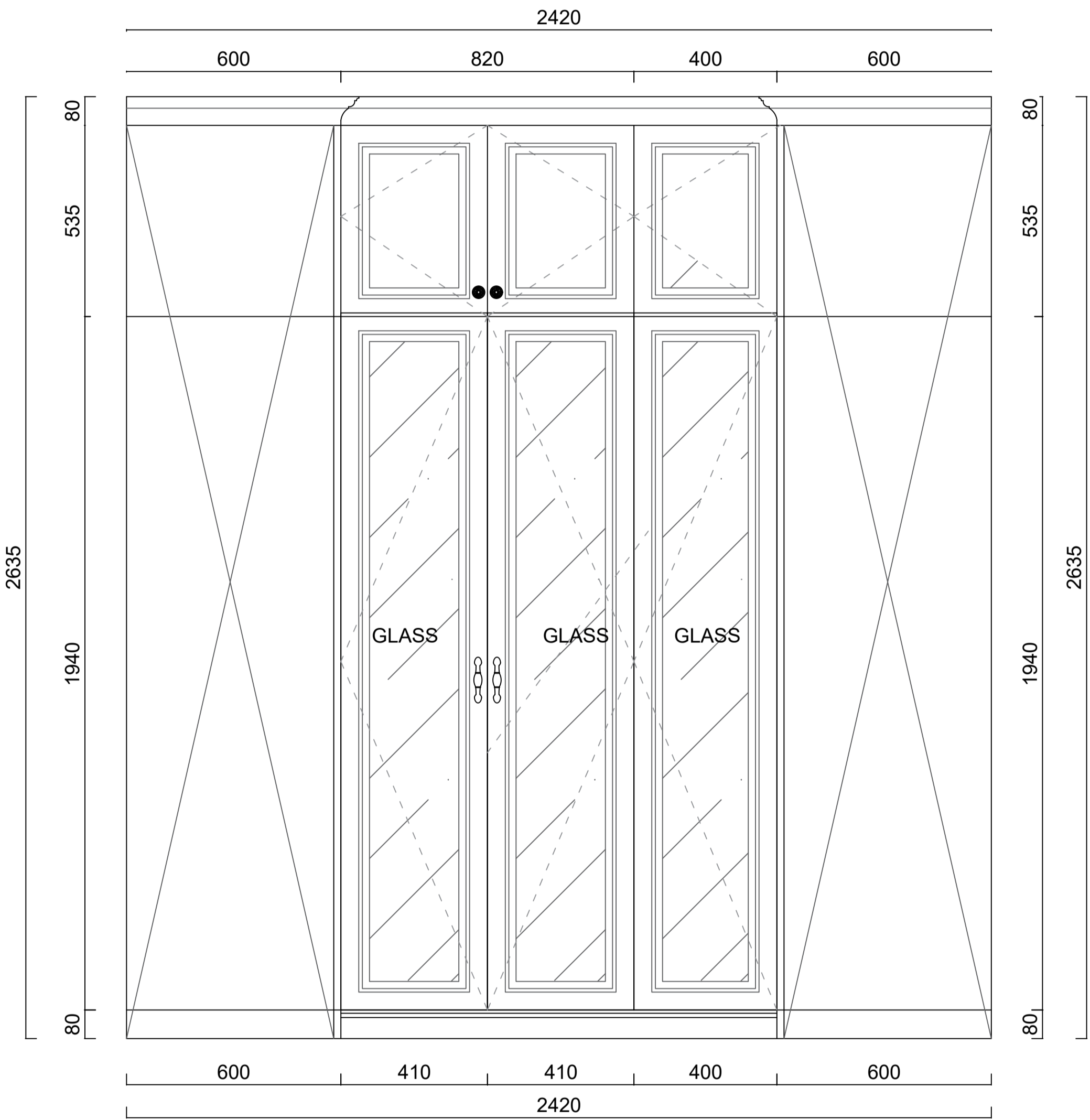

C ELEVATION

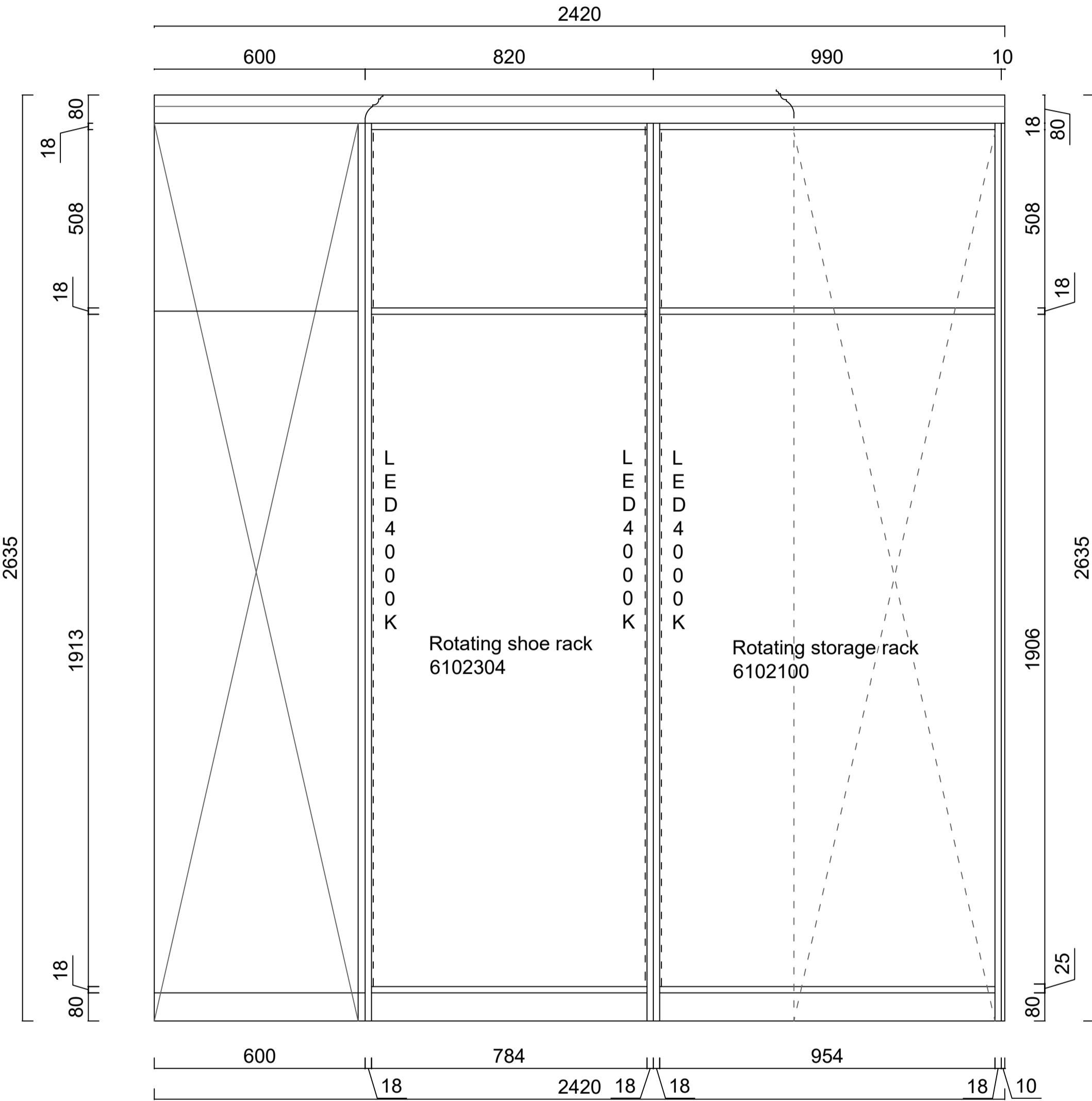

C STRUCTURE

HIS WARDROBE

WAYMOVE
One Stop Home Solutions



Order No: WMAU241130001

Client Name: Rashid

Email:

Client Address: Australia

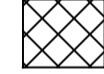
Room Space: HIS

Carcass Material	<input type="checkbox"/> MFC E0 18MM
	<input checked="" type="checkbox"/> JXM5014
Door Material	<input type="checkbox"/> HDF E0 18MM
	<input checked="" type="checkbox"/> Veneer
Door Shape	<input checked="" type="checkbox"/> 
	<input type="checkbox"/> 

Drawer Handle:

Door Handle:

Remark:

Design Date:

Lead Time: 10-12 Weeks

Consignee:

Date:

Designer:

Tel:

Pages 15/11

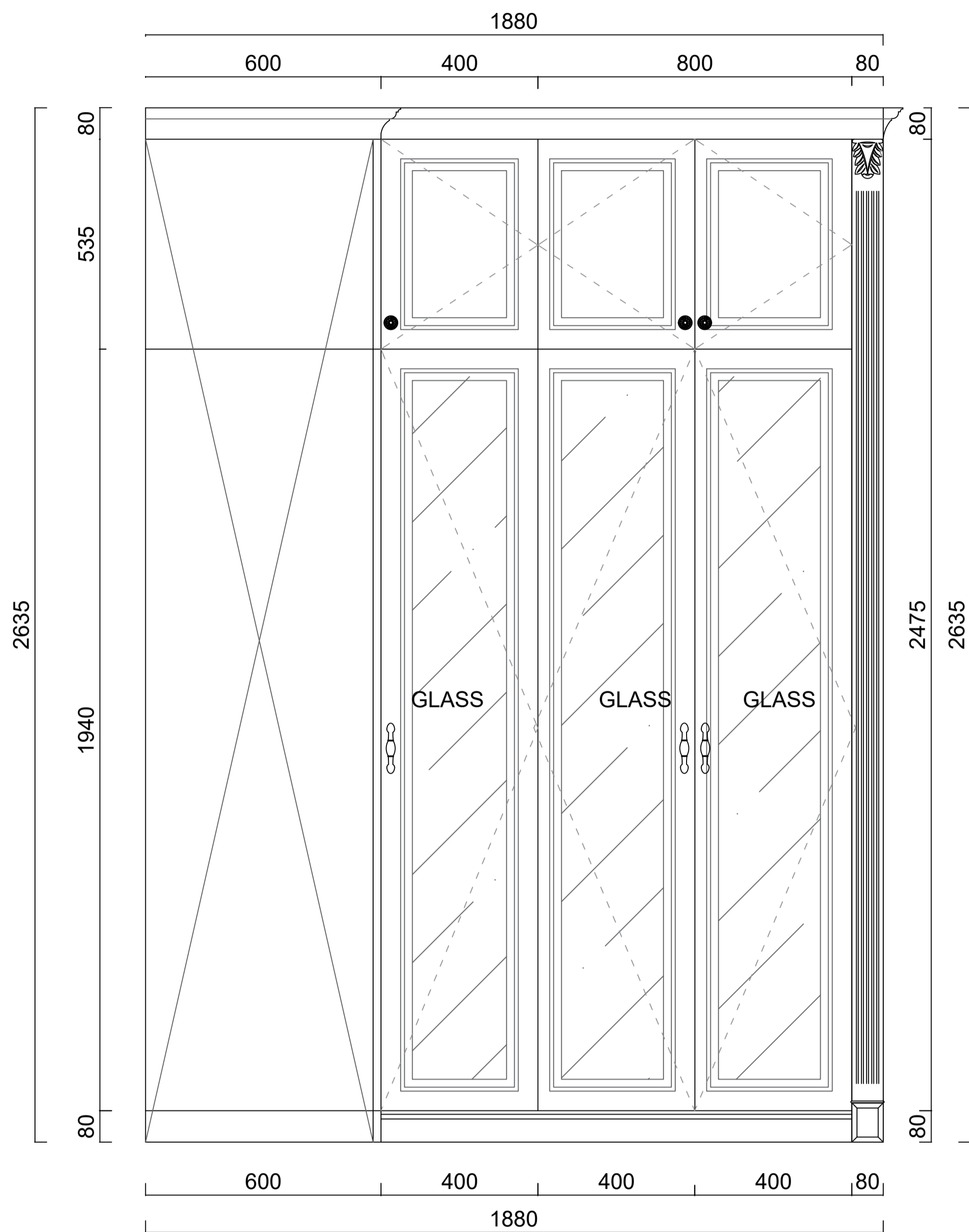

D ELEVATION

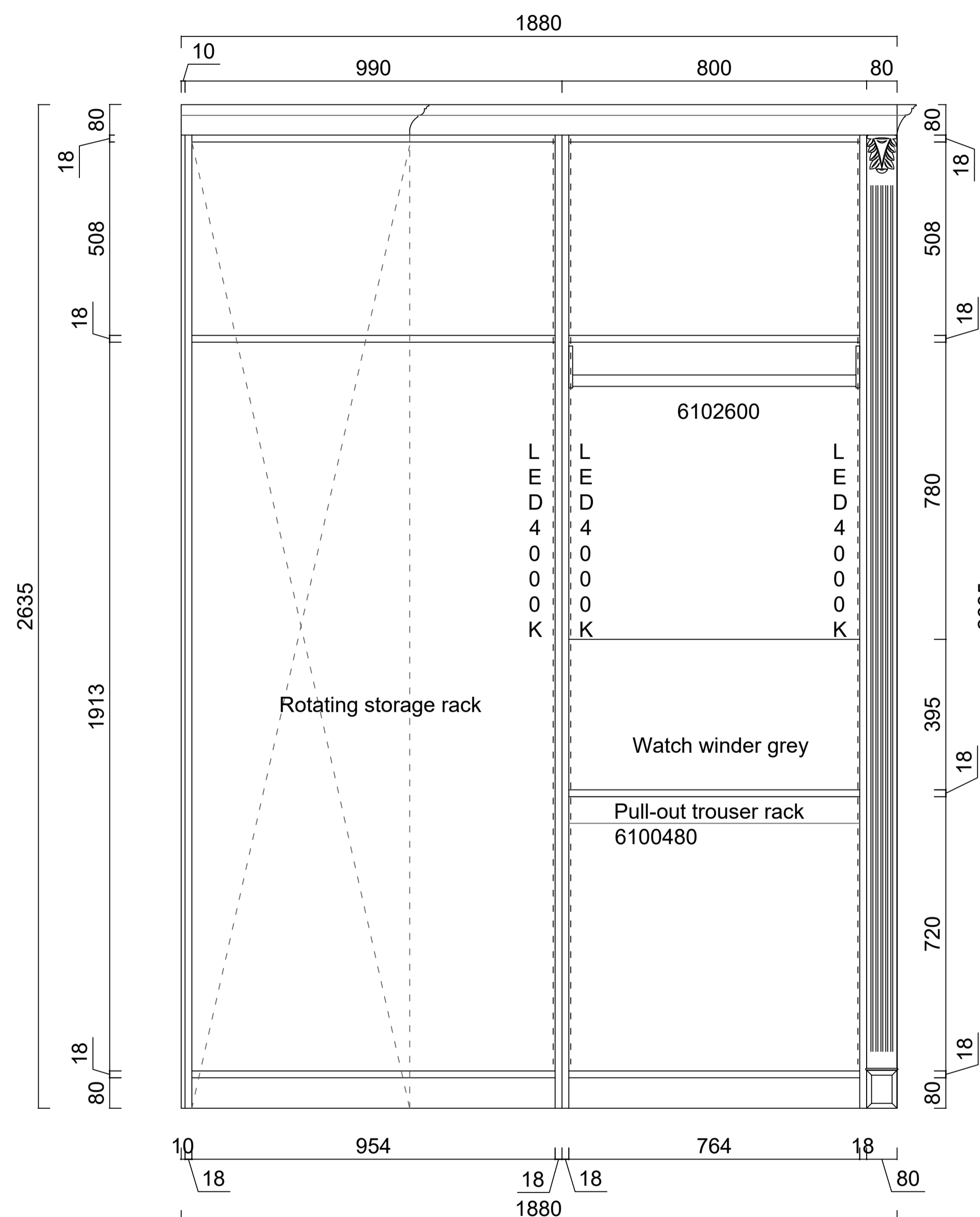

D STRUCTURE

HIS WARDROBE

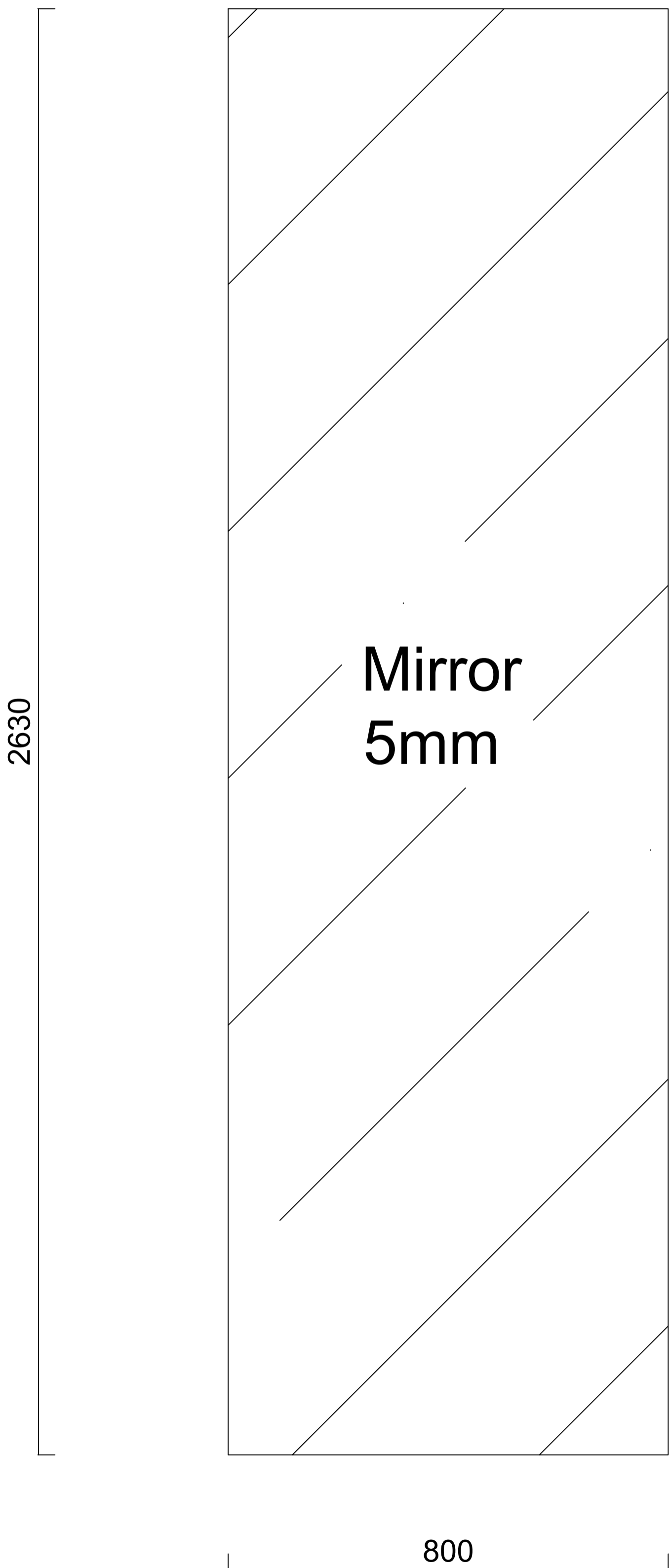

WAYMOVE
One Stop Home Solutions

Order No: WMAU241130001

Client Name: Rashid

Email:

Client Address: Australia

Room Space: HIS

Carcass MFC E0 18MM

Material JXM5014

Door HDF E0 18MM

Material Veneer

Door

Shape

Drawer Handle:

Door Handle:

Remark:

Design Date:

Lead Time: 10-12 Weeks

Consignee:

Date:

Designer:

Tel:

Pages

19/12

VANITY

WAYMOVE

One Stop Home Solutions

Order No: WMAU241130001

Client Name: Rashid

Email:

Client Address: Australia

Room Space: BATHROOM

Carcass MFC E0 18MM

Material DY1058

Door HDF E0 18MM

Material Painted

Door Shape

Drawer Handle:

Door Handle:

Remark:

Design Date:

Lead Time: 10-12 Weeks

Consignee:

Date:

Designer:

Tel:

Pages

19/13

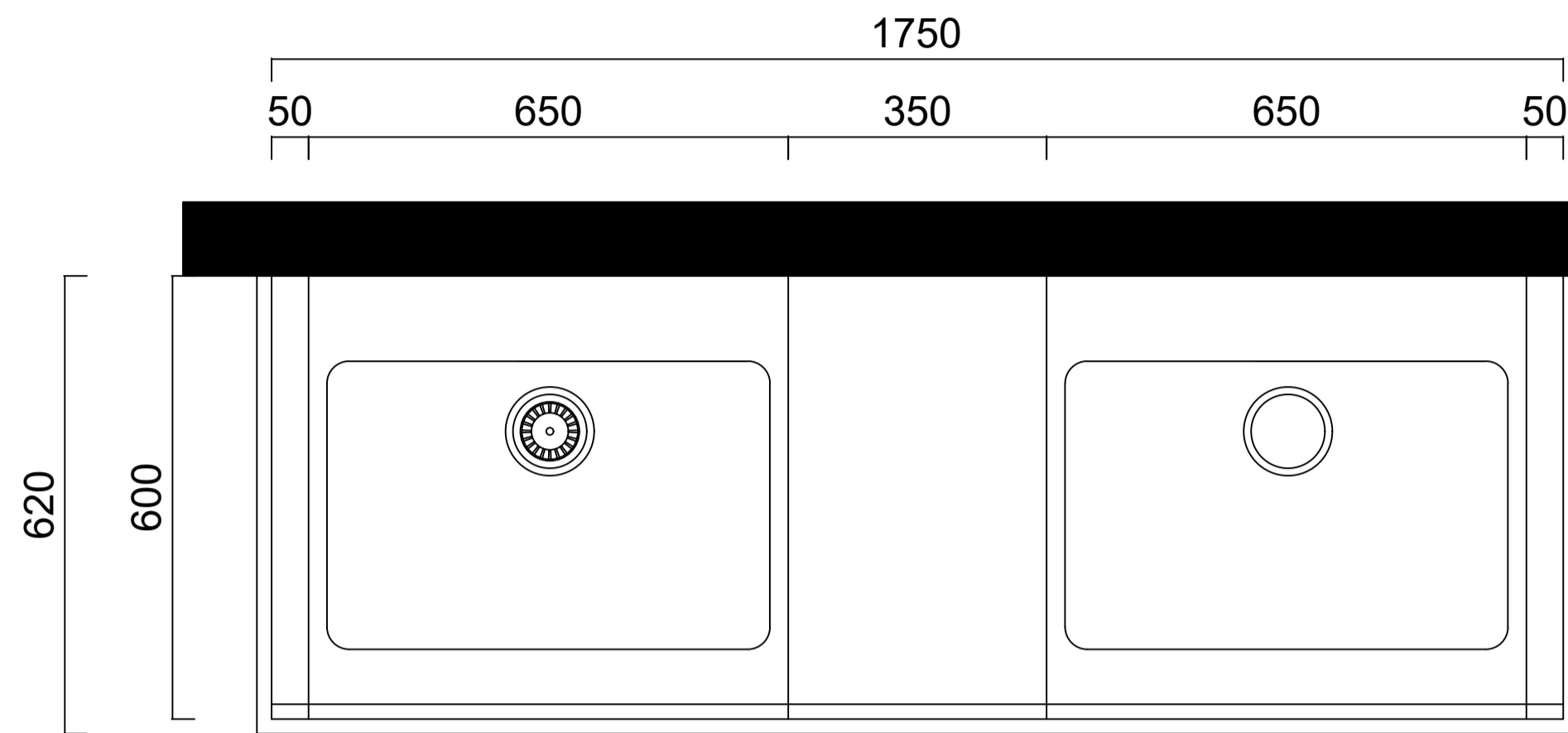

PLAN

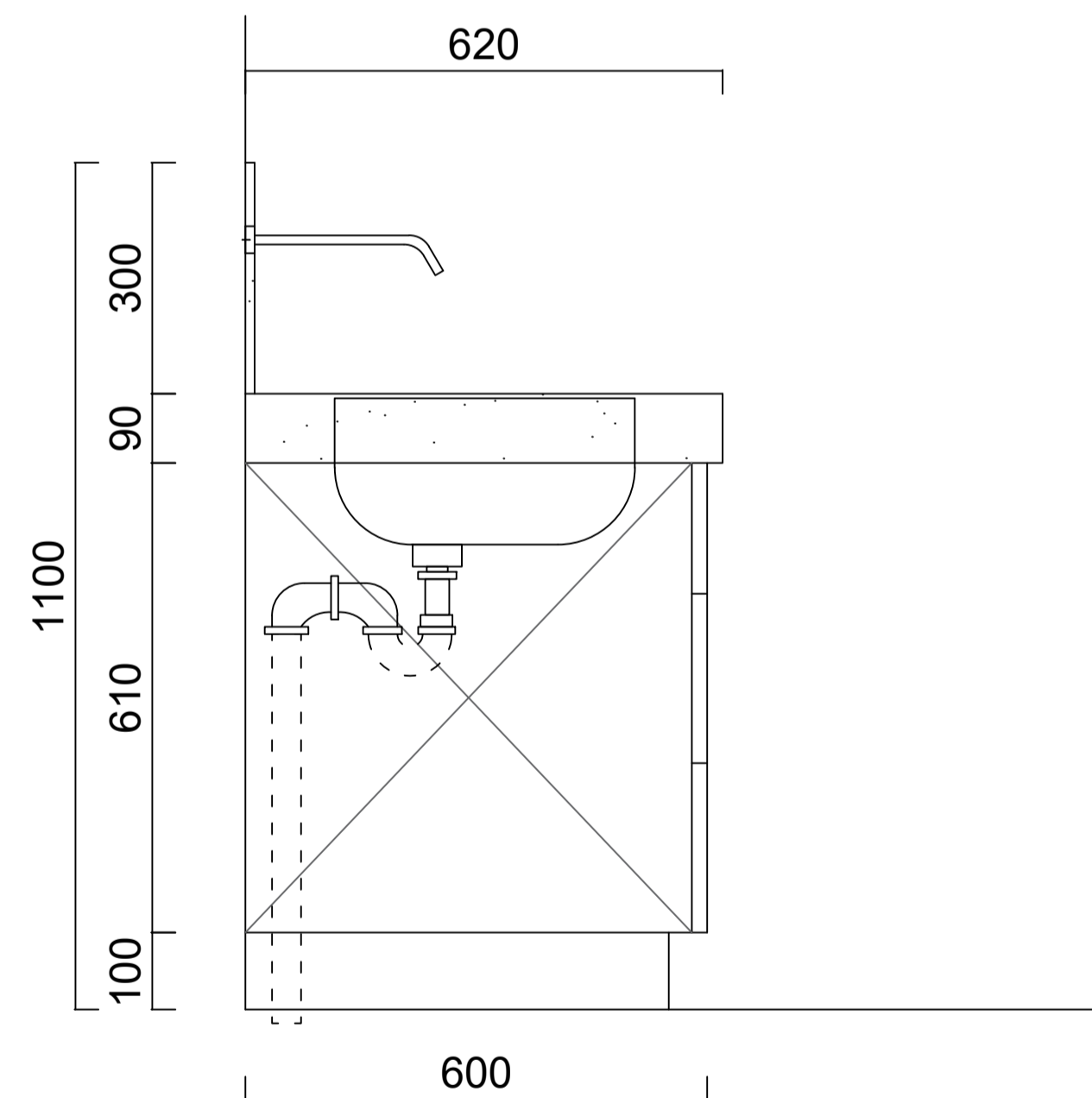
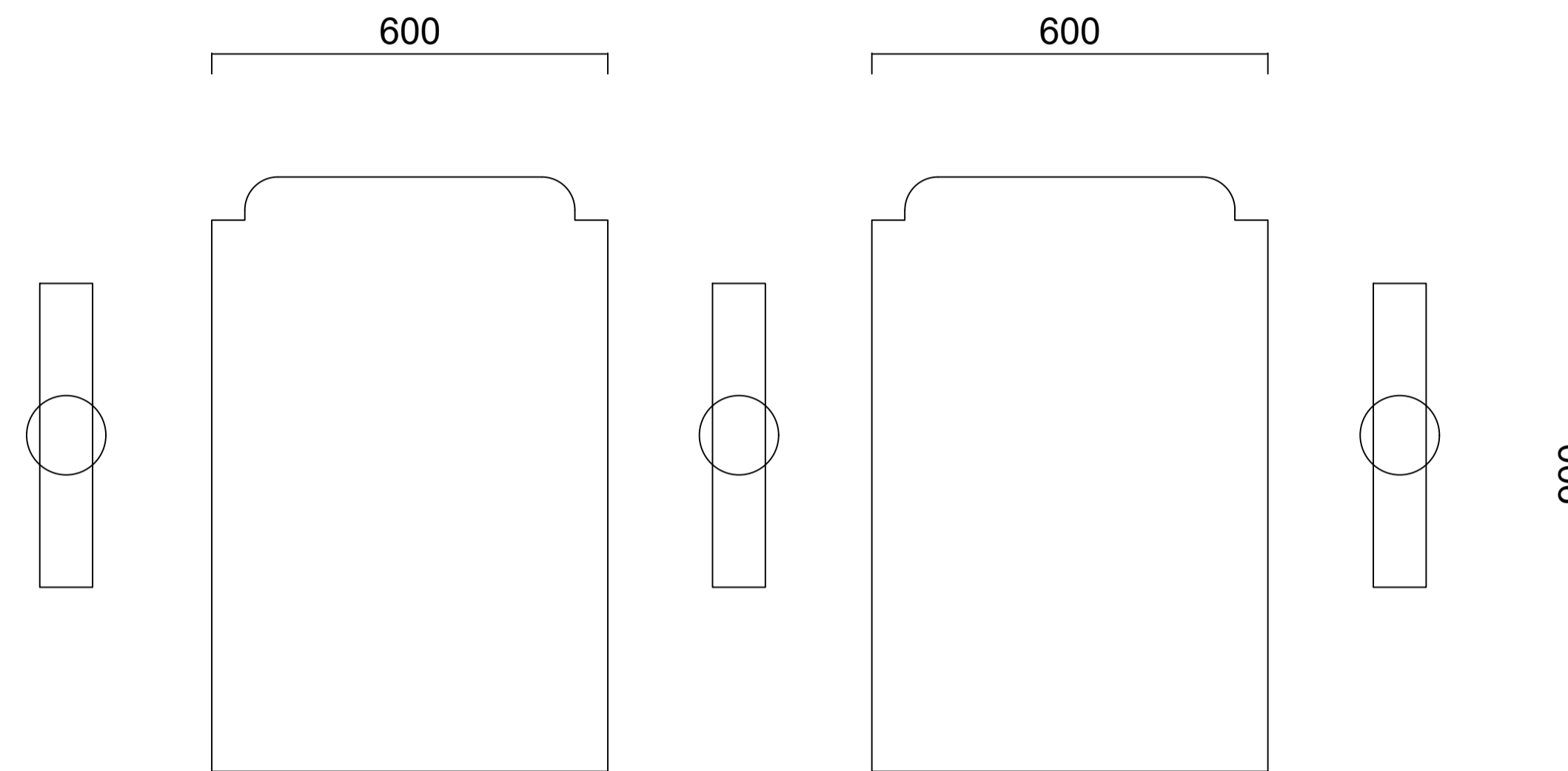

SIDE

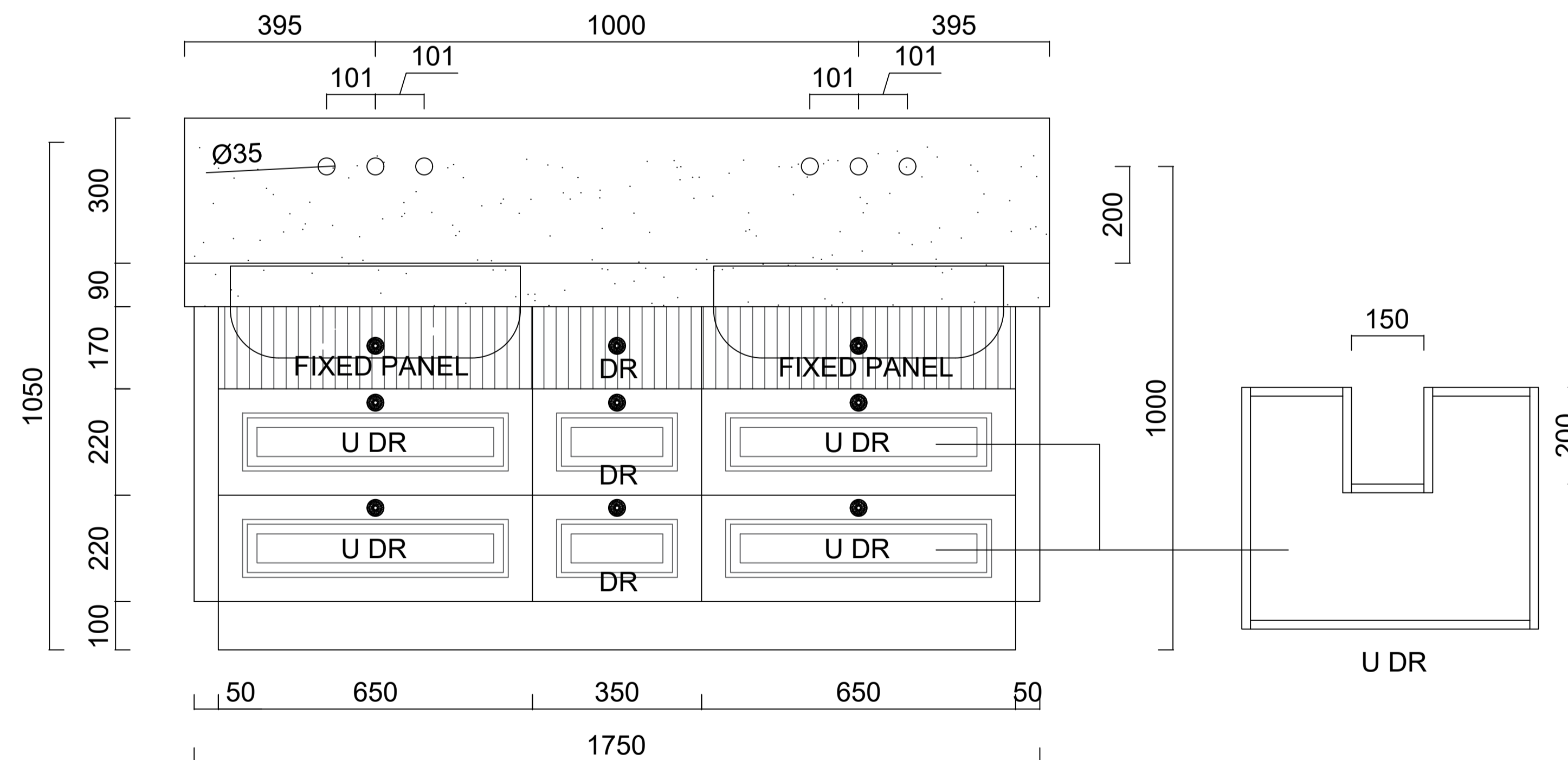

ELEVATION

VANITY

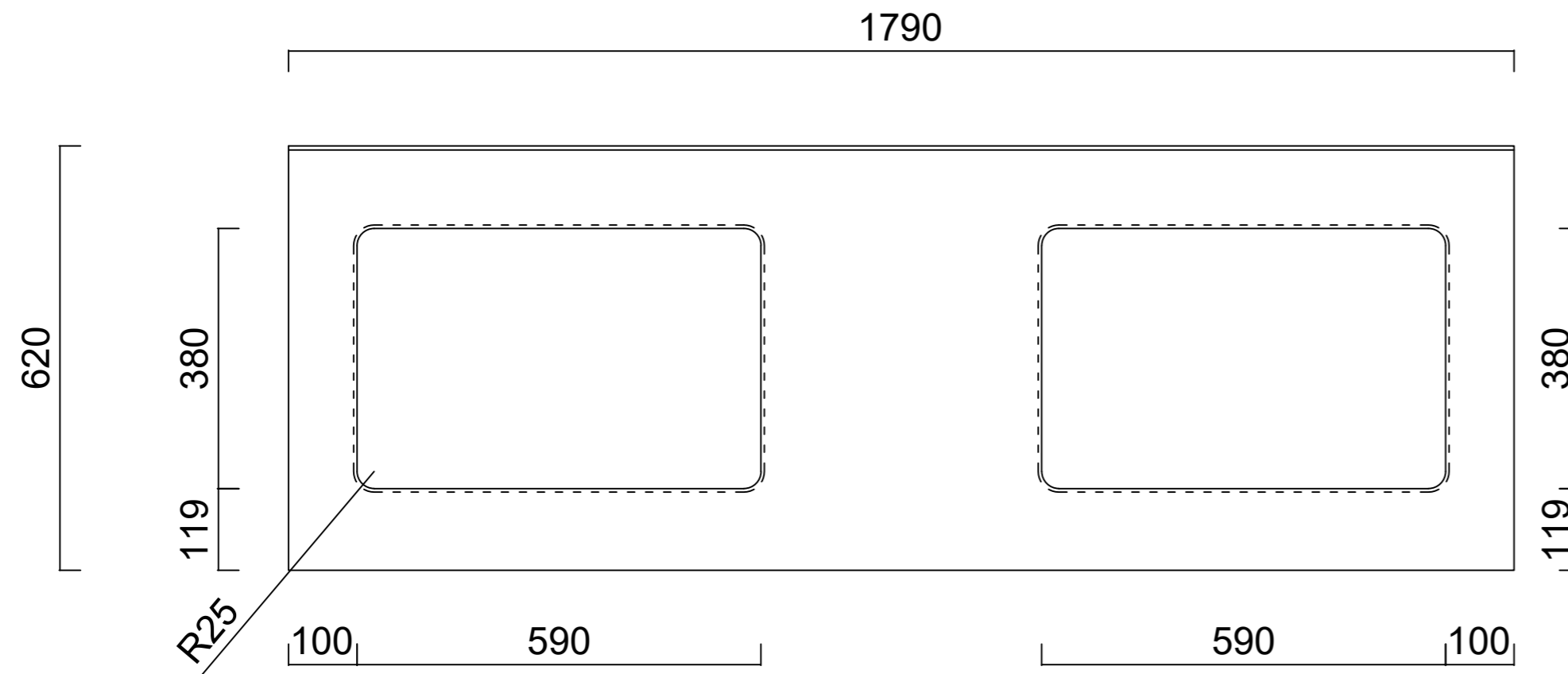
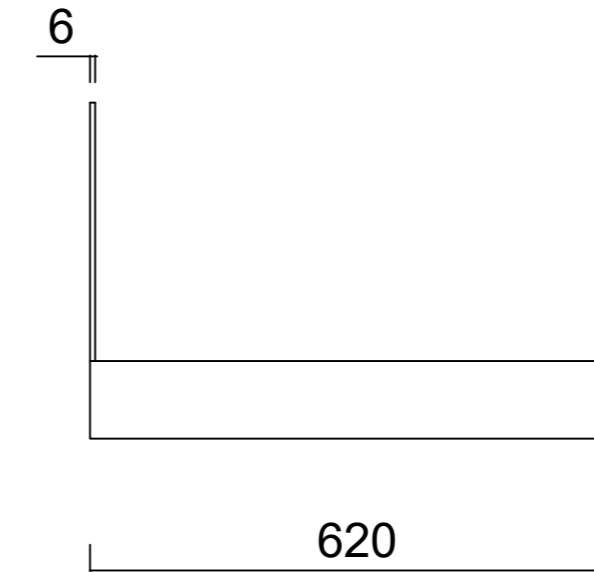
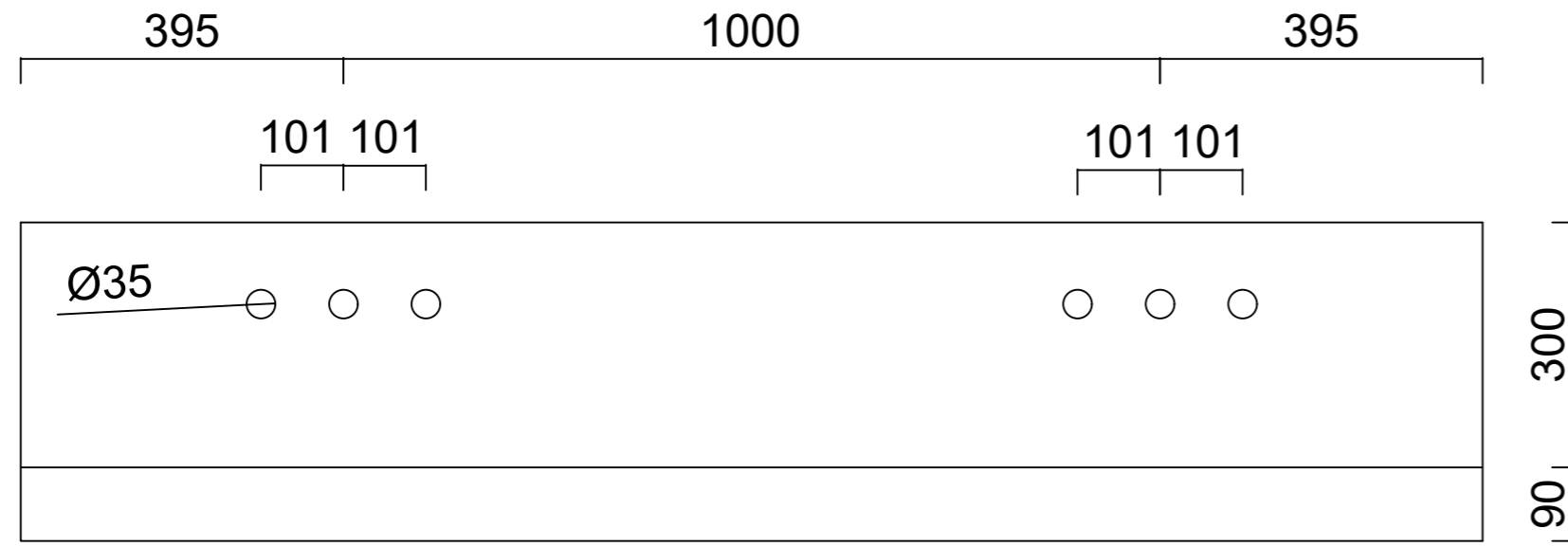

WAYMOVE
One Stop Home Solutions

Order No: WMAU241130001

Client Name: Rashid

Email:

Client Address: Australia

Room Space: BATHROOM

Carcass Material MFC E0 18MM
 DY1058

Door Material HDF E0 18MM
 Painted

Door Shape

Drawer Handle:

Door Handle:

Remark:

Design Date:

Lead Time: 10-12 Weeks

Consignee:

Date:

Designer:

Tel:

Pages 19/14

KITCHENETTE

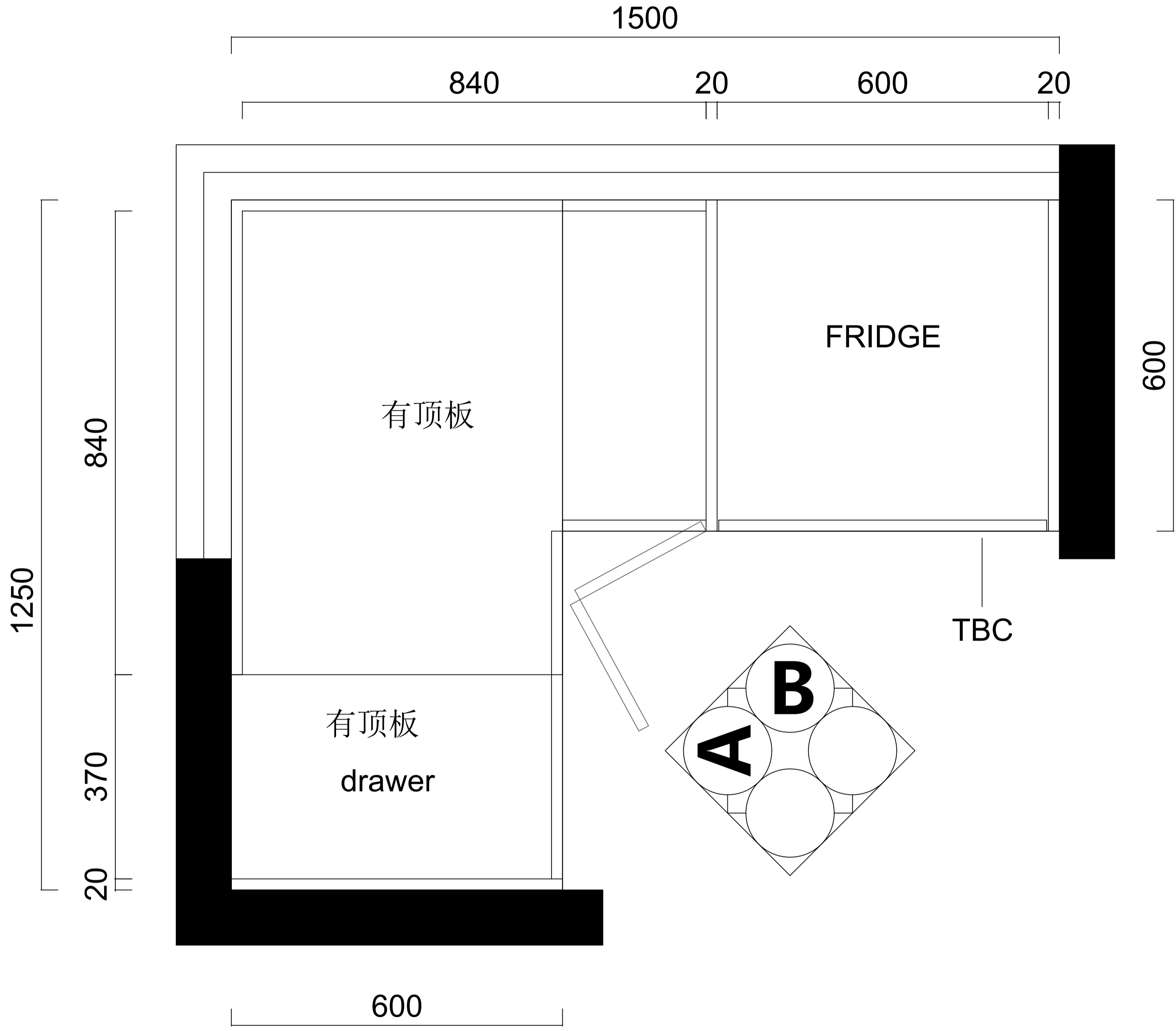

PLAN

WAYMOVE
One Stop Home Solutions

Order No: WMAU241130001

Client Name: Rashid

Email:

Client Address: Australia

Room Space: KITCHENETTE

Carcass Material	<input type="checkbox"/> MFC E0 18MM
	<input checked="" type="checkbox"/> FW1052
Door Material	<input type="checkbox"/> HDF E0 18MM
	<input checked="" type="checkbox"/> Veneer
Door Shape	<input checked="" type="checkbox"/>
	<input type="checkbox"/>

Drawer Handle:

Door Handle:

Remark:

Design Date:

Lead Time: 10-12 Weeks

Consignee:

Date:

Designer:

Tel:

KITCHENETTE

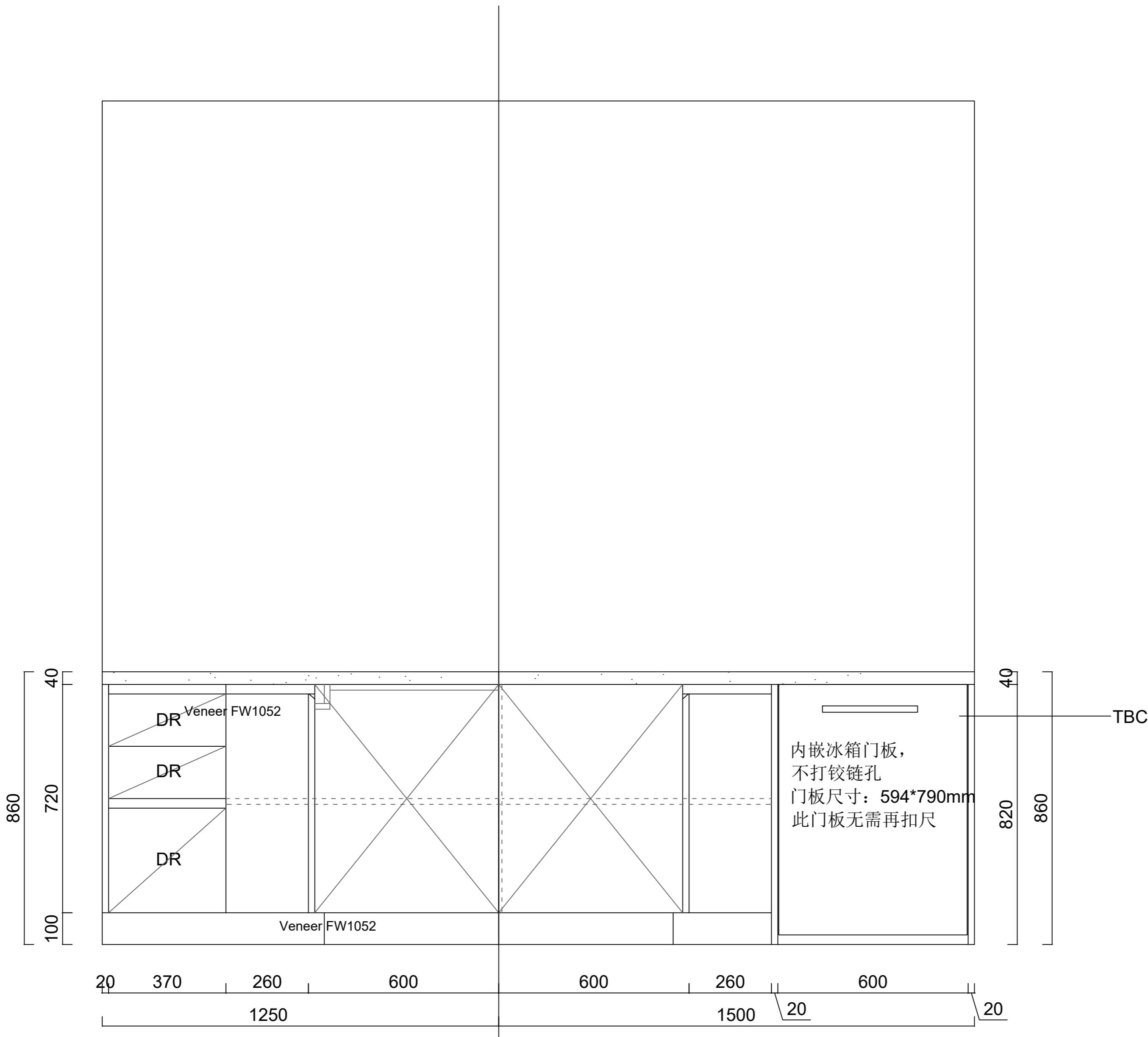

A ELEVATION

B ELEVATION

WAYMOVE
One Stop Home Solutions

Order No: WMAU241130001

Client Name: Rashid

Email:

Client Address: Australia

Room Space: KITCHENETTE

Carcass Material MFC E0 18MM
 FW1052

Door Material HDF E0 18MM
 Veneer

Door Shape

Drawer Handle:

Door Handle:

Remark:

Design Date:

Lead Time: 10-12 Weeks

Consignee:

Date:

Designer:

Tel:

Pages 19/16

KITCHENETTE

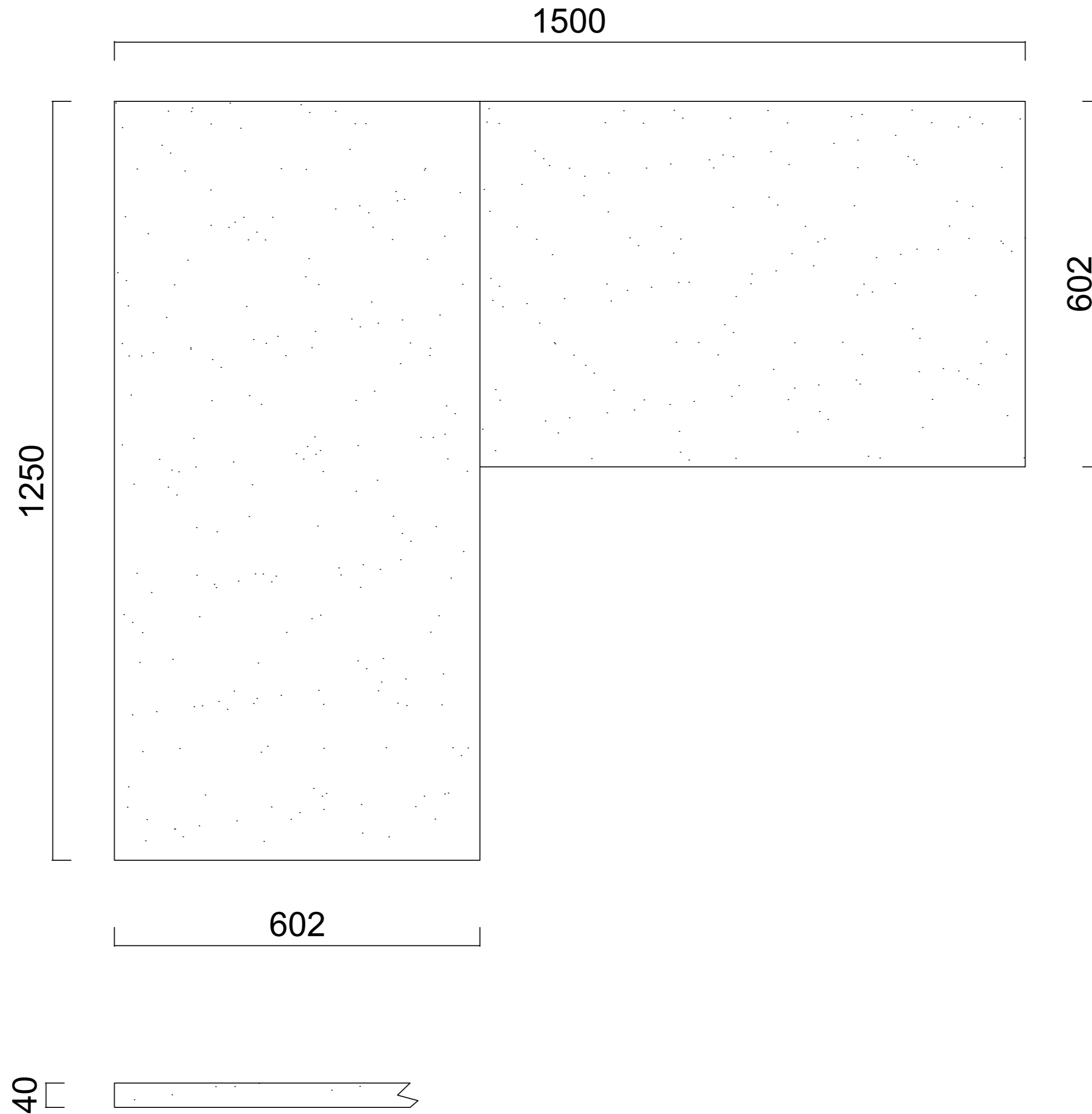

WAYMOVE
One Stop Home Solutions

Order No: WMAU241130001

Client Name: Rashid

Email:

Client Address: Australia

Room Space: KITCHENETTE

Carcass Material	<input type="checkbox"/> MFC E0 18MM
	<input checked="" type="checkbox"/> FW1052

Door Material	<input type="checkbox"/> HDF E0 18MM
	<input checked="" type="checkbox"/> Veneer

Door Shape	<input checked="" type="checkbox"/>
	<input type="checkbox"/>

Drawer Handle:

Door Handle:

Remark:

Design Date:

Lead Time: 10-12 Weeks

Consignee:

Date:

Designer:

Tel:

Pages	19/17
-------	-------

BUFFET TABLE

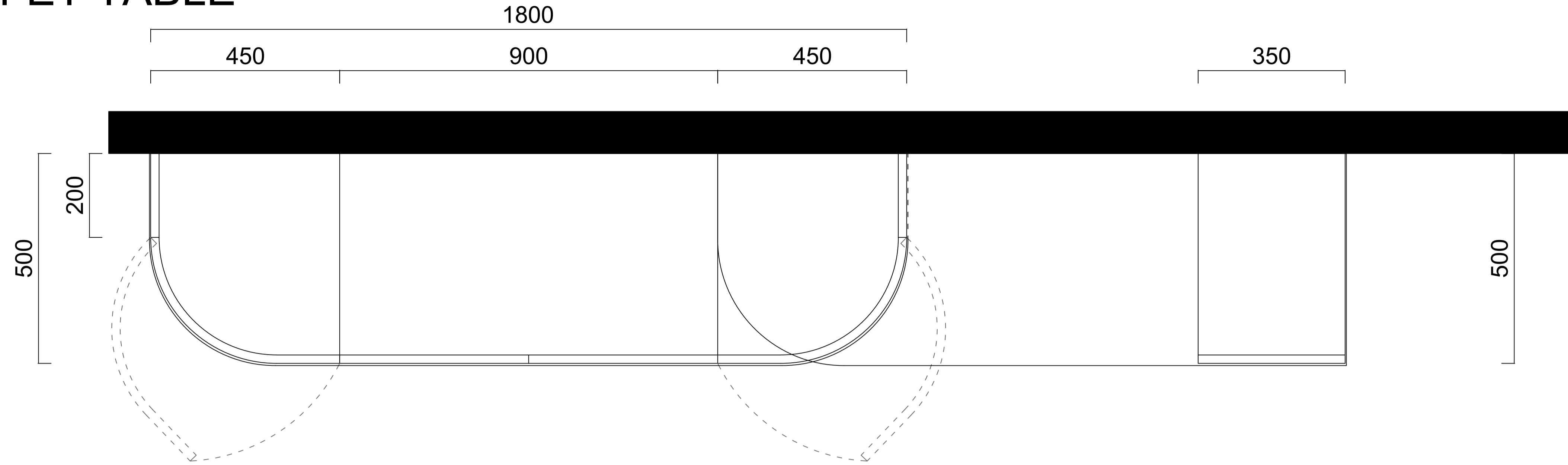

PLAN

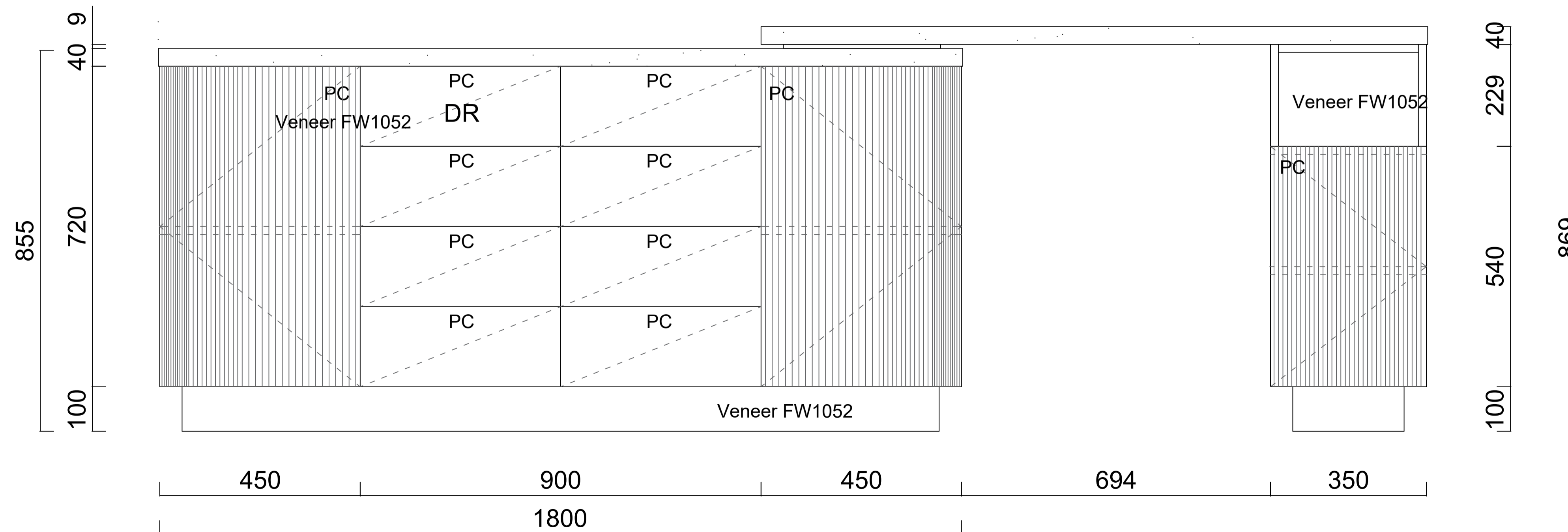

ELEVATION

WAYMOVE
One Stop Home Solutions

Order No: WMAU241130001

Client Name: Rashid

Email:

Client Address: Australia

Room Space: BUFFET TABLE

Carcass Material	<input type="checkbox"/> MFC E0 18MM
	<input checked="" type="checkbox"/> FW1052
Door Material	<input type="checkbox"/> HDF E0 18MM
	<input checked="" type="checkbox"/> Veneer
Door Shape	<input checked="" type="checkbox"/>
	<input type="checkbox"/>

Drawer Handle:

Door Handle:

Remark:

Design Date:

Lead Time: 10-12 Weeks

Consignee:

Date:

Designer:

Tel:

Pages 19/18

BUFFET TABLE

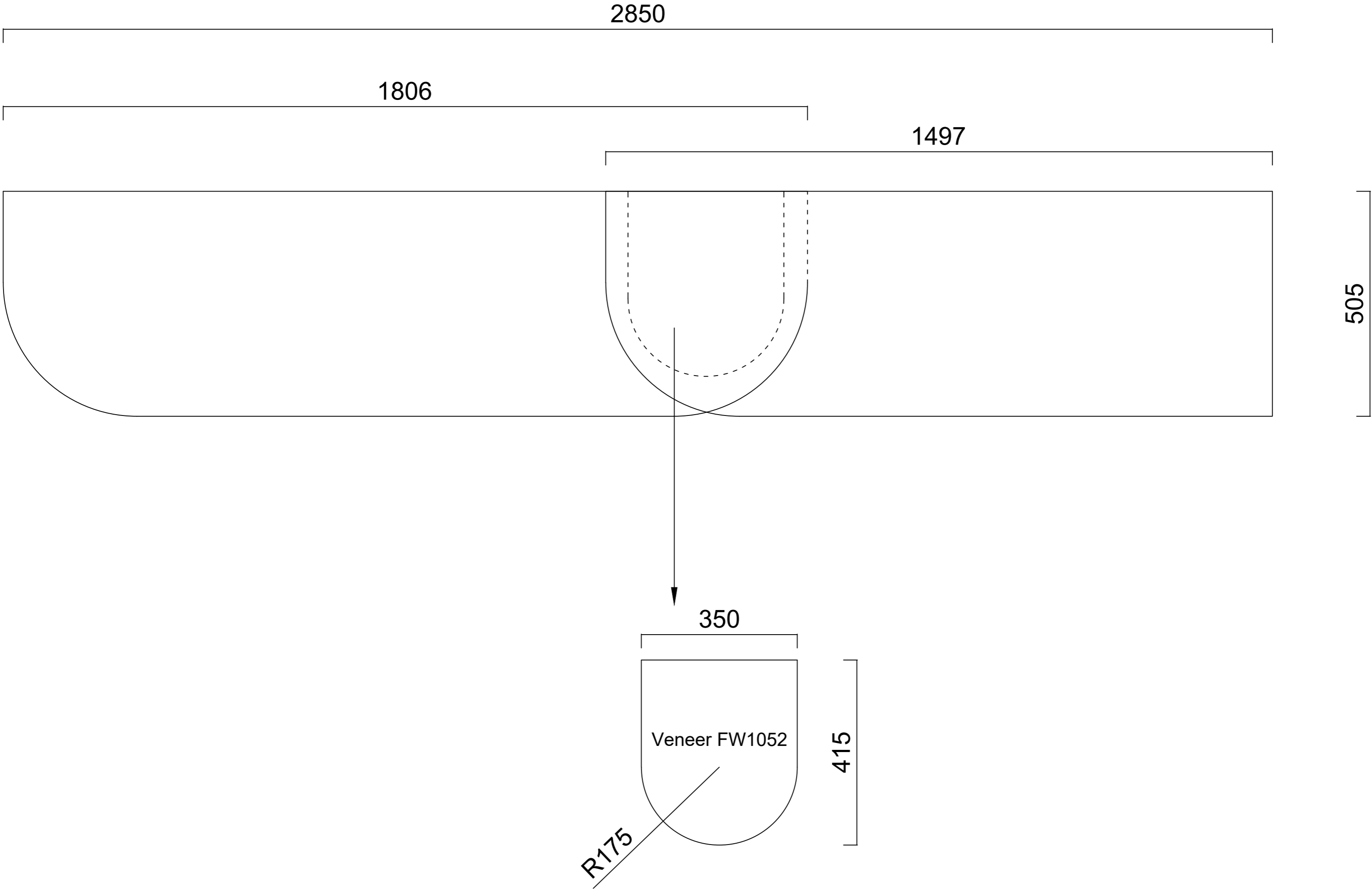

WAYMOVE
One Stop Home Solutions

Order No: WMAU241130001

Client Name: Rashid

Email:

Client Address: Australia

Room Space: BUFFET TABLE

Carcass MFC E0 18MM

Material FW1052

Door HDF E0 18MM

Material Veneer

Door

Shape

Drawer Handle:

Door Handle:

Remark:

Design Date:

Lead Time: 10-12 Weeks

Consignee:

Date:

Designer:

Tel:

Pages 19/19