

Master closet

Master closet



Carcase

Finish: MelamineBA2007
Material: Plywood(E0)
Thickness: 18mm/9 mm

柜体/多层板BA2007



Carcase

Finish: MelamineBA2006
Material: Plywood(E0)
Thickness: 18mm/9 mm

柜体/多层板BA2006



Aluminum Door

Frame:Black
Glass:Gray

铝框玻璃门
黑色边框/灰玻

Master closet



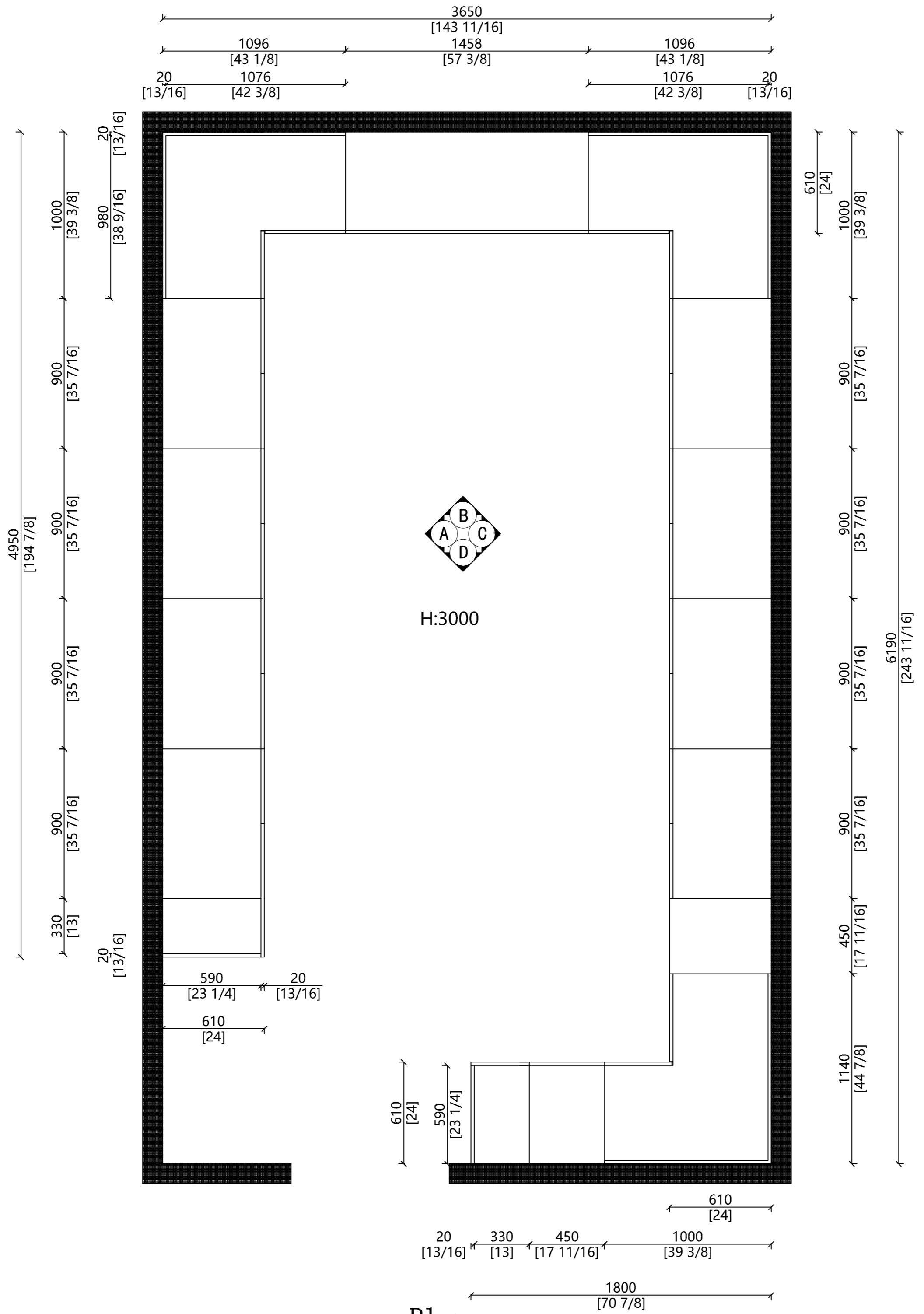

Plan

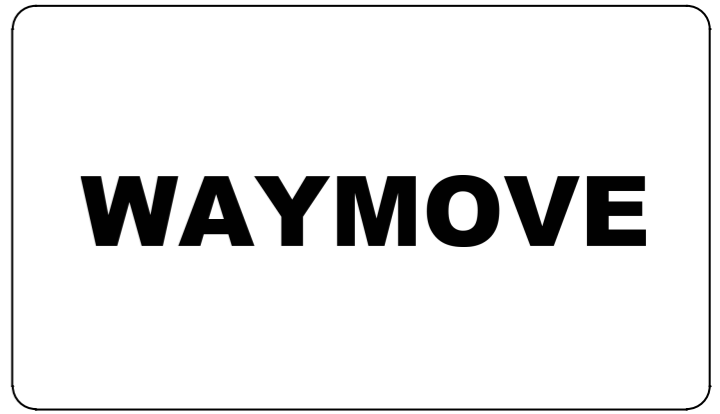

Order No: LEIUS20231123001A

Client Name: Shams

Email:

Client Address:

Room Space: Master room

Carcass	
Material	
Door	<input type="checkbox"/>
Material	
Door	
Shape	<input type="checkbox"/>

Drawer Handle:

Door Handle:

Remark:

Design Date:

Lead Time: 10-12 Weeks

Consignee:

Date:

Designer:

Tel:

Pages

Master closet

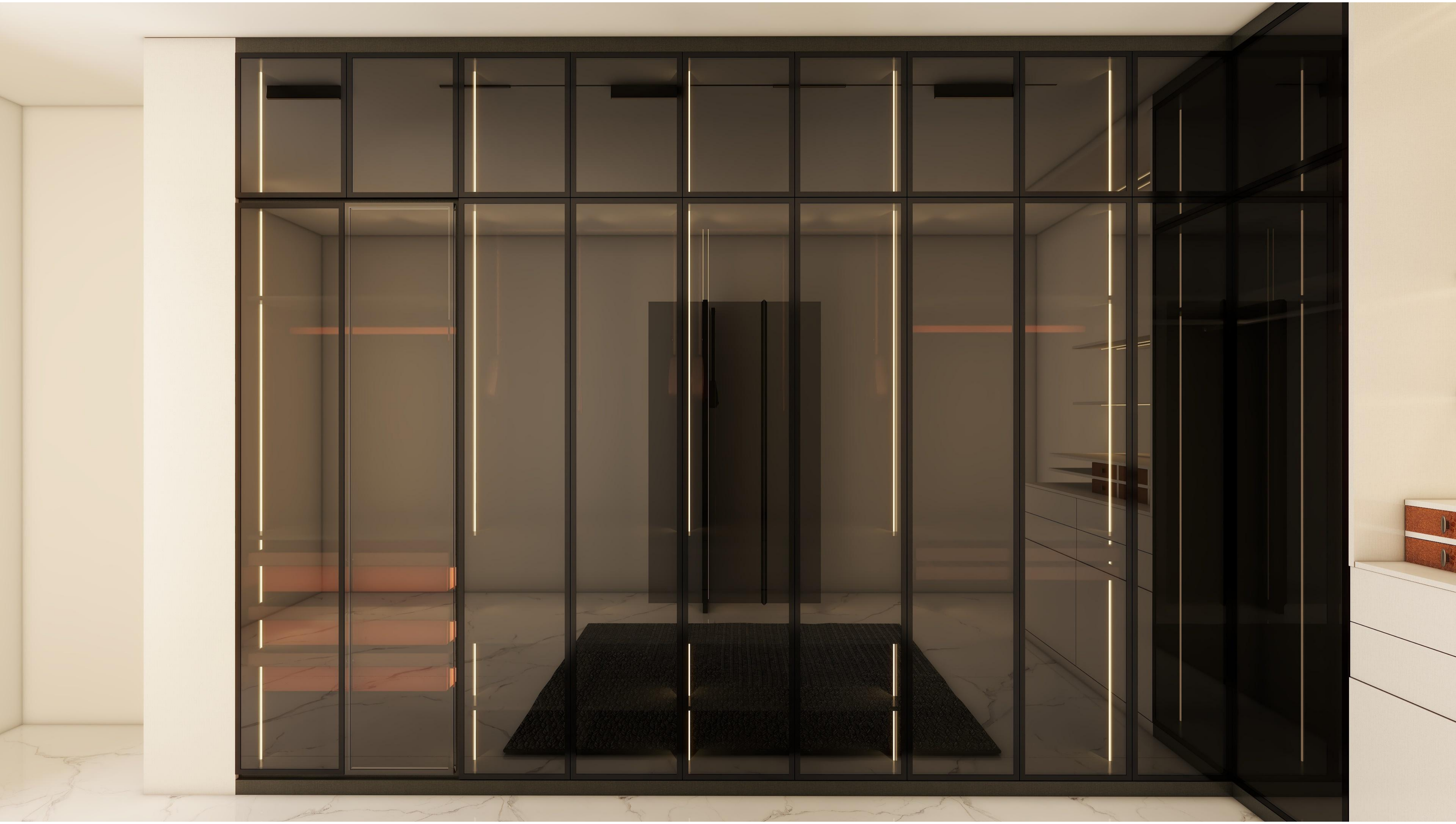

Master closet



6090690
SOFT-CLOSE
DECORATIONS SHELF



6090690
SOFT-CLOSE TROUSERS
RACK



6094590
CLOTHES RAIL COVERED LEATHER
WITH LIGHTING



6090290
SOFT-CLOSE LEATHER
BASKET



6091602
SOFT-CLOSE LIFTABLE HANGER



6092600
HANGING
ROD/HANGING ROD
BASE(TRAPEZOID)

WAYMOVE

Order No: LEIUS20231123001A

Client Name: Shams

Email:

Client Address:

Room Space: Master room

Carcass

Material



Door



Material



Door



Shape



Drawer Handle:

Door Handle:

Remark:

Design Date:

Lead Time: 10-12 Weeks

Consignee:

Date:

Designer:

Tel:

Pages

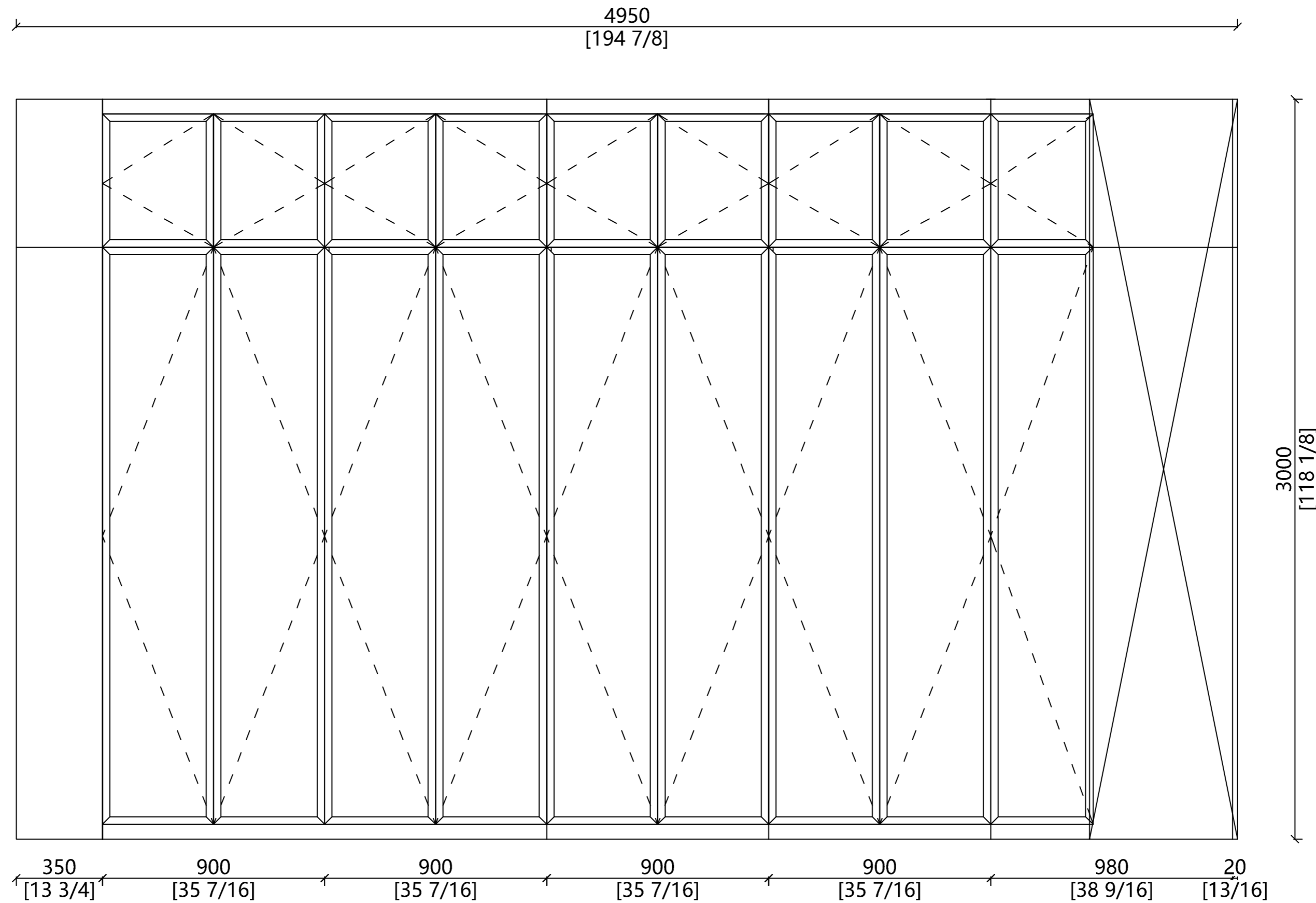
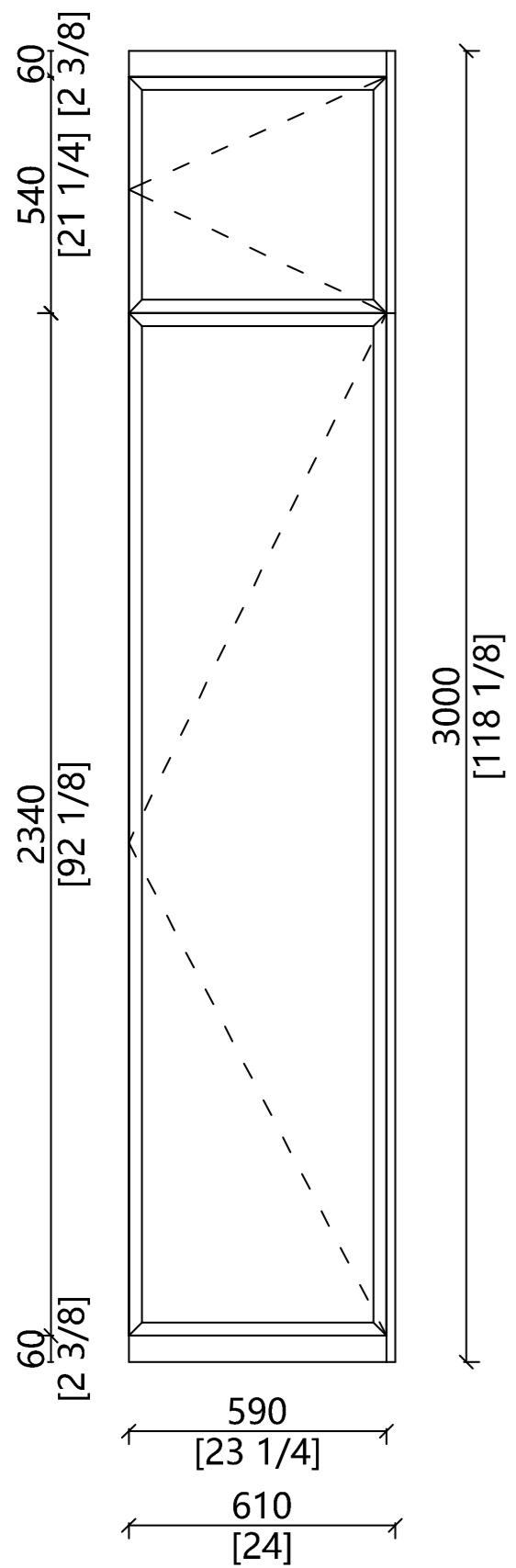

ELEVATION A

WAYMOVE

Order No: LEIUS20231123001A

Client Name: Shams

Email:

Client Address:

Room Space: Master room

Carcass Material	<input checked="" type="checkbox"/>
Door Material	<input type="checkbox"/>
Door Shape	<input checked="" type="checkbox"/>

Drawer Handle:

Door Handle:

Remark:

Design Date:

Lead Time: 10-12 Weeks

Consignee:

Date:

Designer:

Tel:

Pages

LED is installed 100mm from the front
LED 4000K

LED灯带距离前口100mm安装

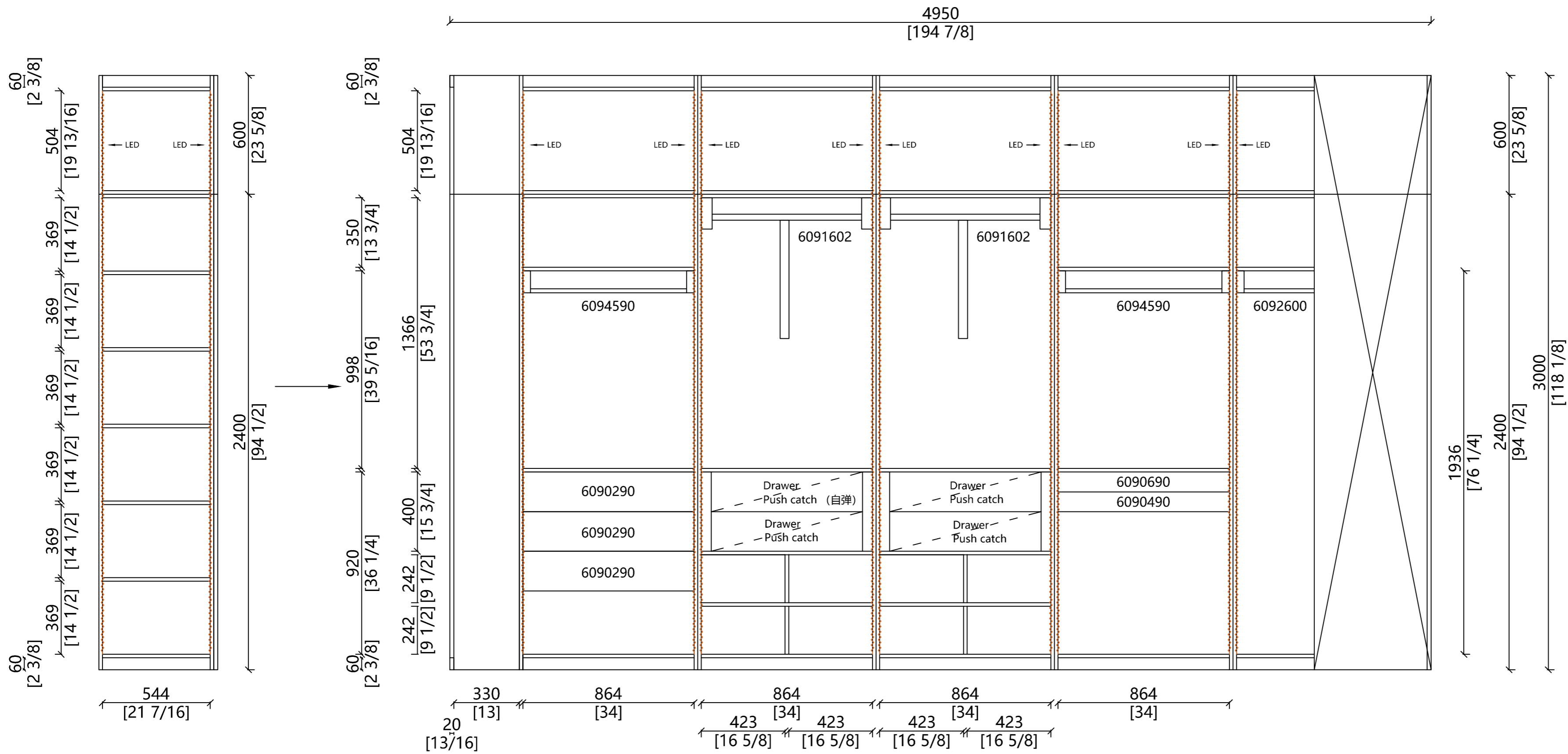

STRUCTURE A

Master closet



6093900
LEATHER STORAGE BOX



6094200
MULTI-FUNCTIONAL
STORAGE BOX



6093700
MULTI-FUNCTION RING BOX



6093600
MULTI-FUNCTIONAL
STORAGE BOX



6093800
MULTI-FUNCTION WATCH
BOX



6043003
TOUCH-SCREEN SMART CODE CASE

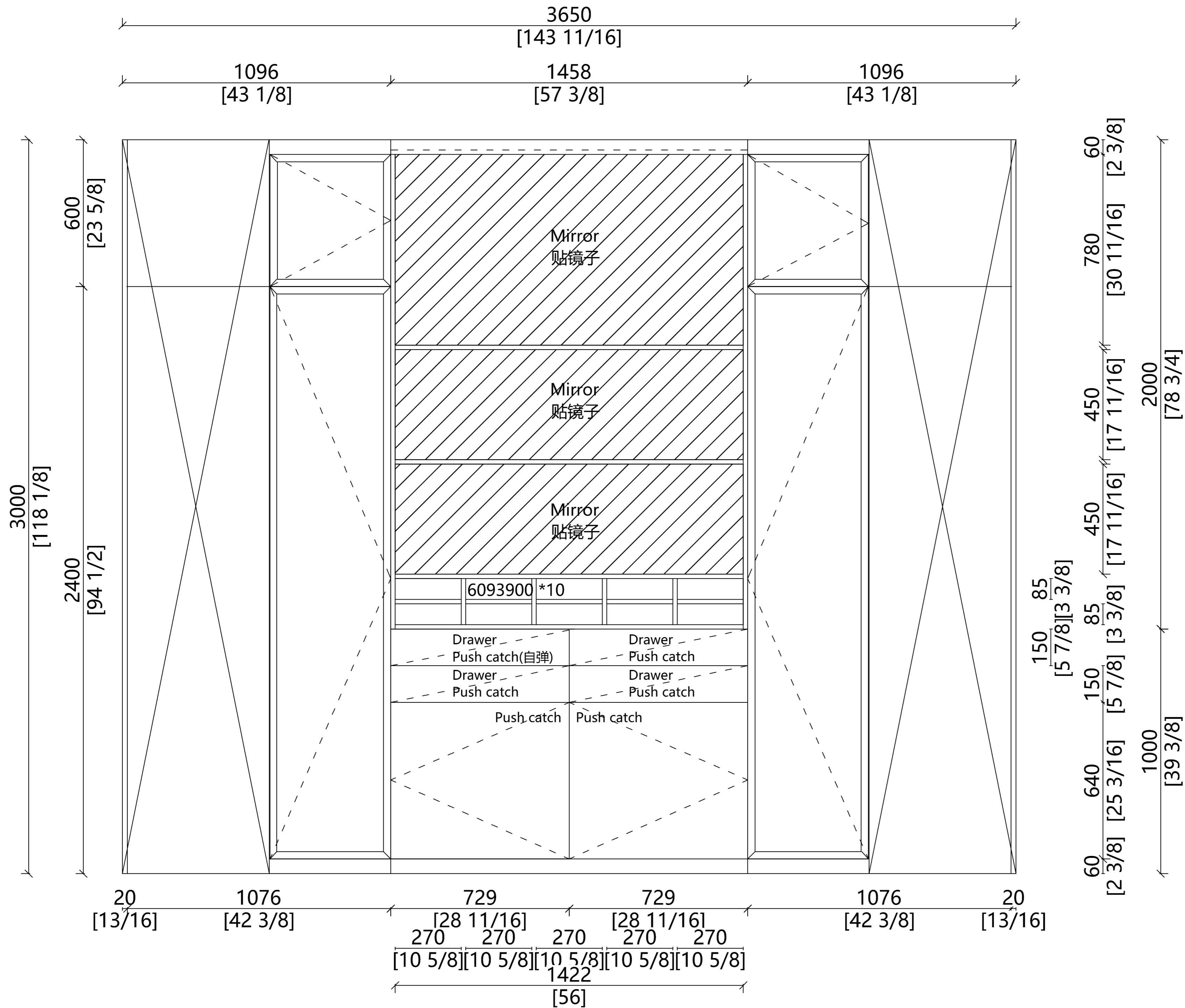

ELEVATION B



Order No: LEIUS20231123001A	
Client Name: Shams	
Email:	
Client Address:	
Room Space: Master room	
Carcass Material	<input checked="" type="checkbox"/>
Door Material	<input checked="" type="checkbox"/>
Door Shape	<input checked="" type="checkbox"/>
Drawer Handle:	
Door Handle:	
Remark:	
Design Date:	
Lead Time: 10-12 Weeks	
Consignee:	
Date:	
Designer:	
Tel:	
Pages	

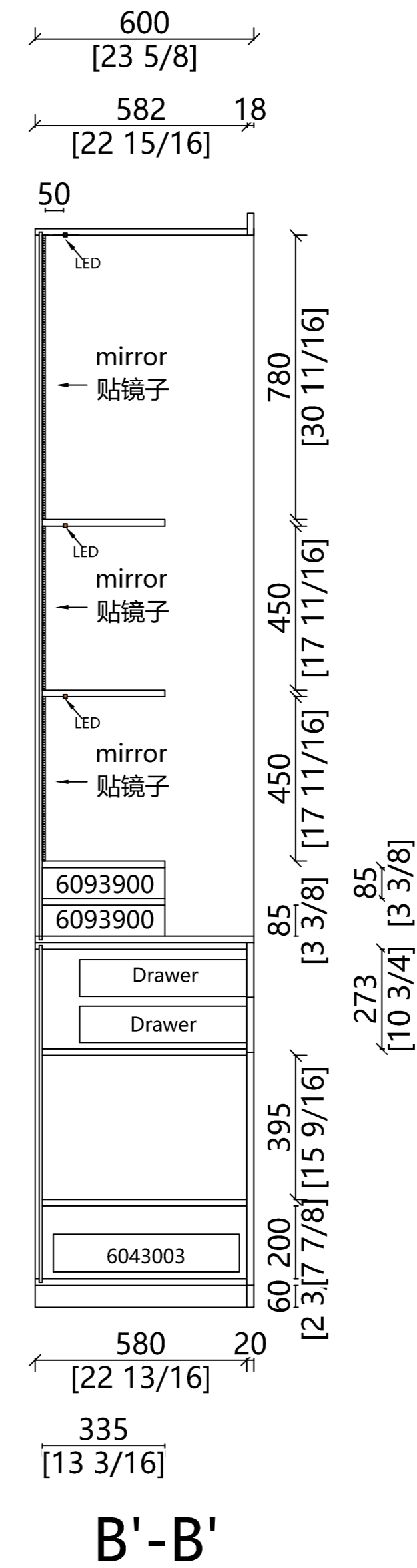
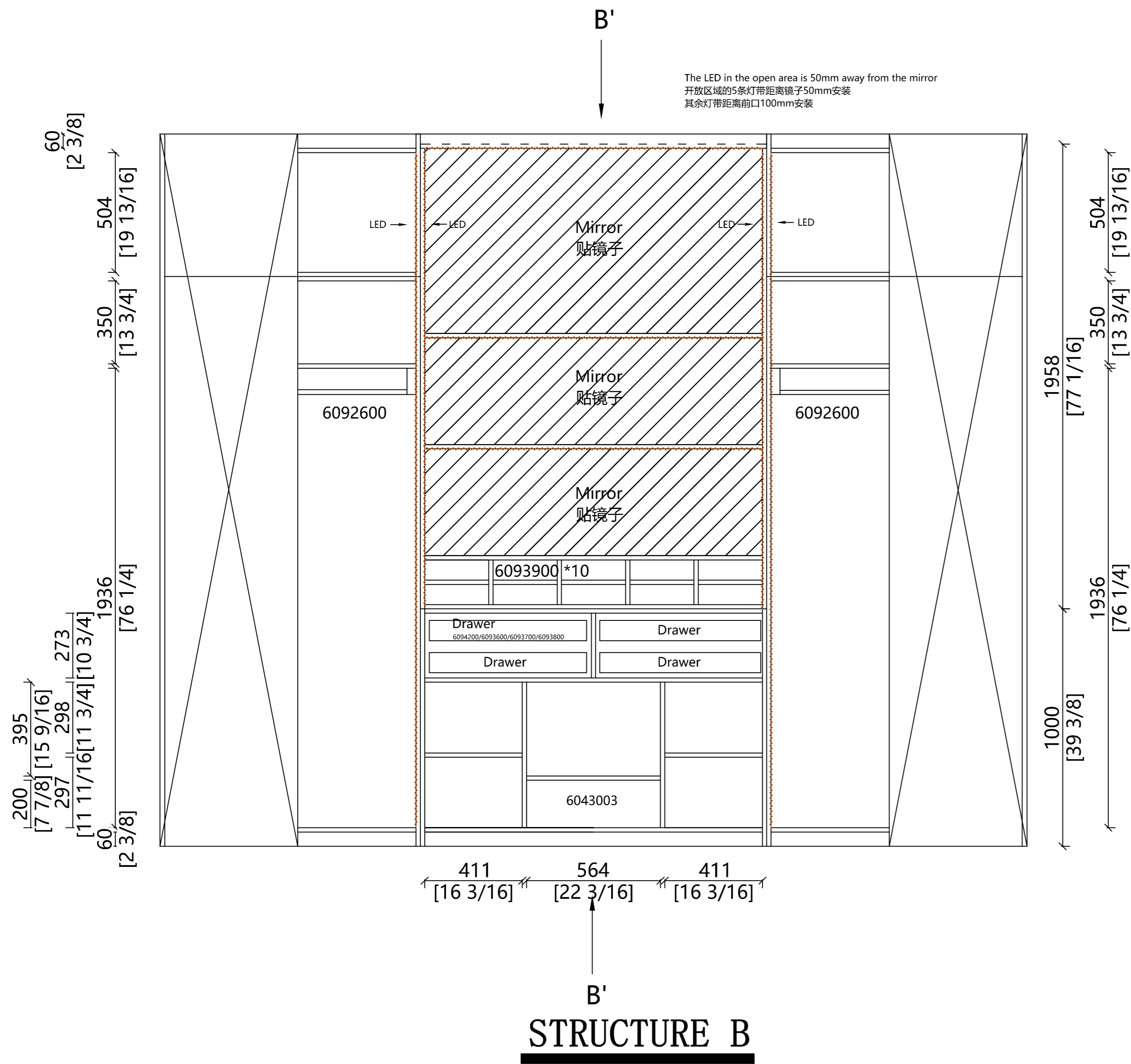

WAYMOVE

Order No: LEIUS20231123001A

Client Name: Shams

Email:

Client Address:

Room Space: Master room

Carcass	
Material	<input checked="" type="checkbox"/>
Door	<input type="checkbox"/>
Material	<input checked="" type="checkbox"/>
Door	<input checked="" type="checkbox"/>
Shape	<input type="checkbox"/>

Drawer Handle:

Door Handle:

Remark:

Design Date:

Lead Time: 10-12 Weeks

Consignee:

Date:

Designer:

Tel:

Pages

Master closet



Master closet



6092600
HANGING
ROD/HANGING ROD
BASE(TRAPEZOID)



6094590
CLOTHES RAIL COVERED LEATHER
WITH LIGHTING



6091602
SOFT-CLOSE LIFTABLE HANGER



6090390
UNDERWEAR SHELF



6090690
SOFT-CLOSE TROUSERS
RACK

WAYMOVE





Order No: LEIUS20231123001A

Client Name: Shams

Email:

Client Address:

Room Space: Master room

Carcass	
Material	
Door	
Material	
Door	
Shape	

Drawer Handle:

Door Handle:

Remark:

Design Date:

Lead Time: 10-12 Weeks

Consignee:

Date:

Designer:

Tel:

Pages

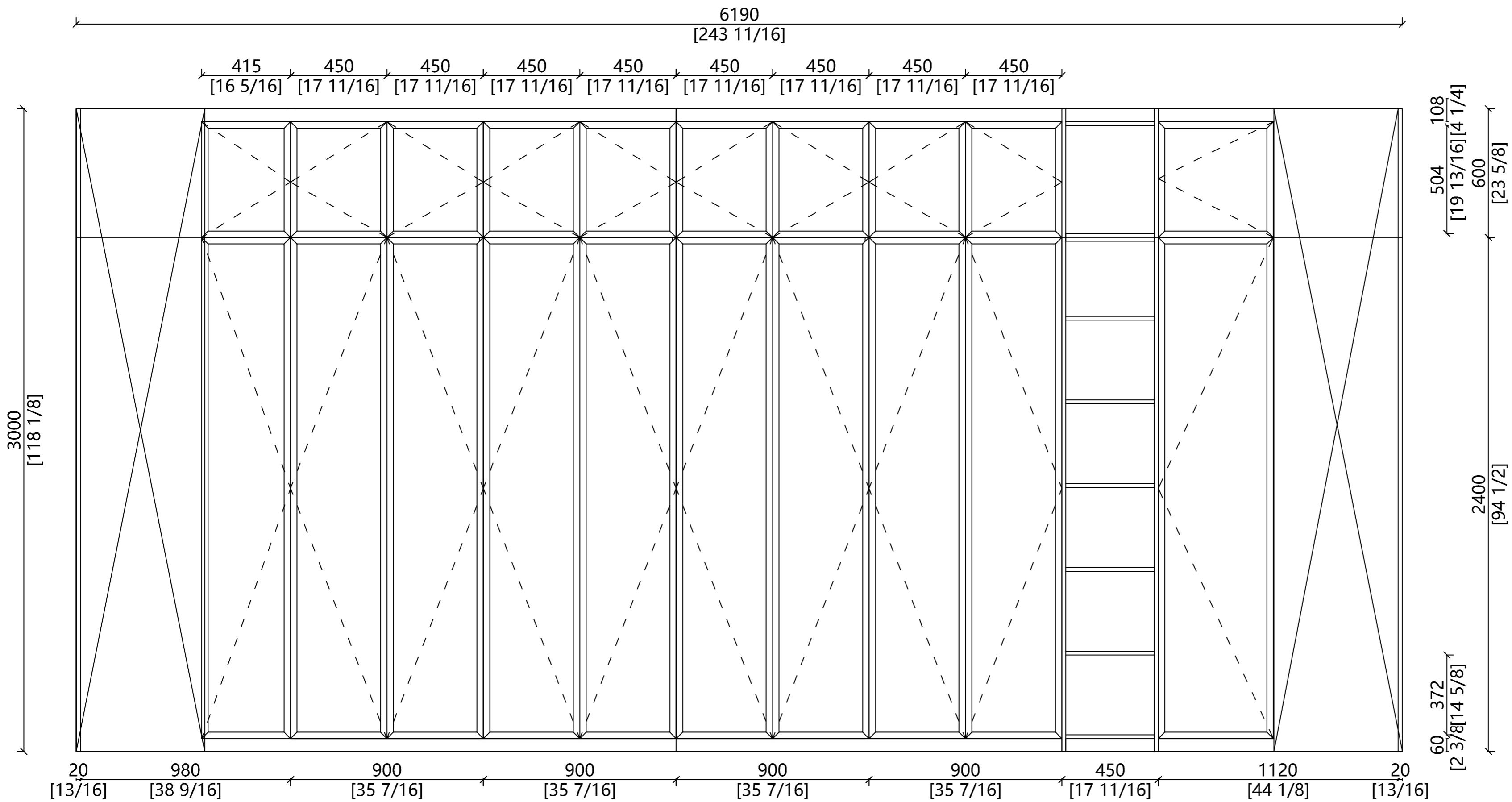

ELEVATION C



Order No: LEIUS20231123001A

Client Name: Shams

Email:

Client Address:

Room Space: Master room

Carcass Material	<input checked="" type="checkbox"/>
Door Material	<input type="checkbox"/>
Door Shape	<input checked="" type="checkbox"/>

Drawer Handle:

Door Handle:

Remark:

Design Date:

Lead Time: 10-12 Weeks

Consignee:

Date:

Designer:

Tel:

Pages

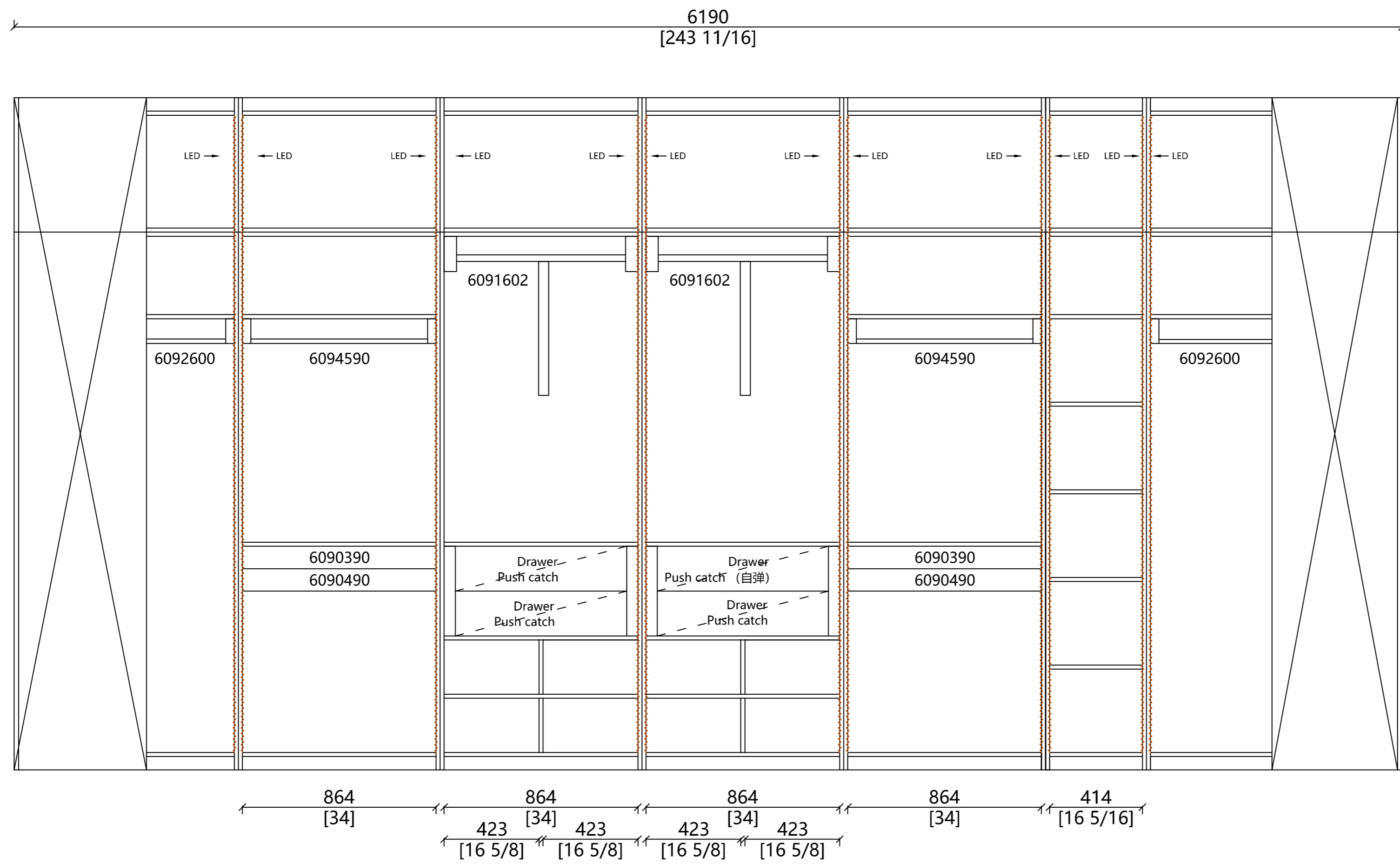

STRUCTURE C

Master closet



Master closet



6092600

6092600
HANGING
ROD/HANGING ROD
BASE(TRAPEZOID)



6051500
SOFT-CLOSING TIE RACK

Master closet

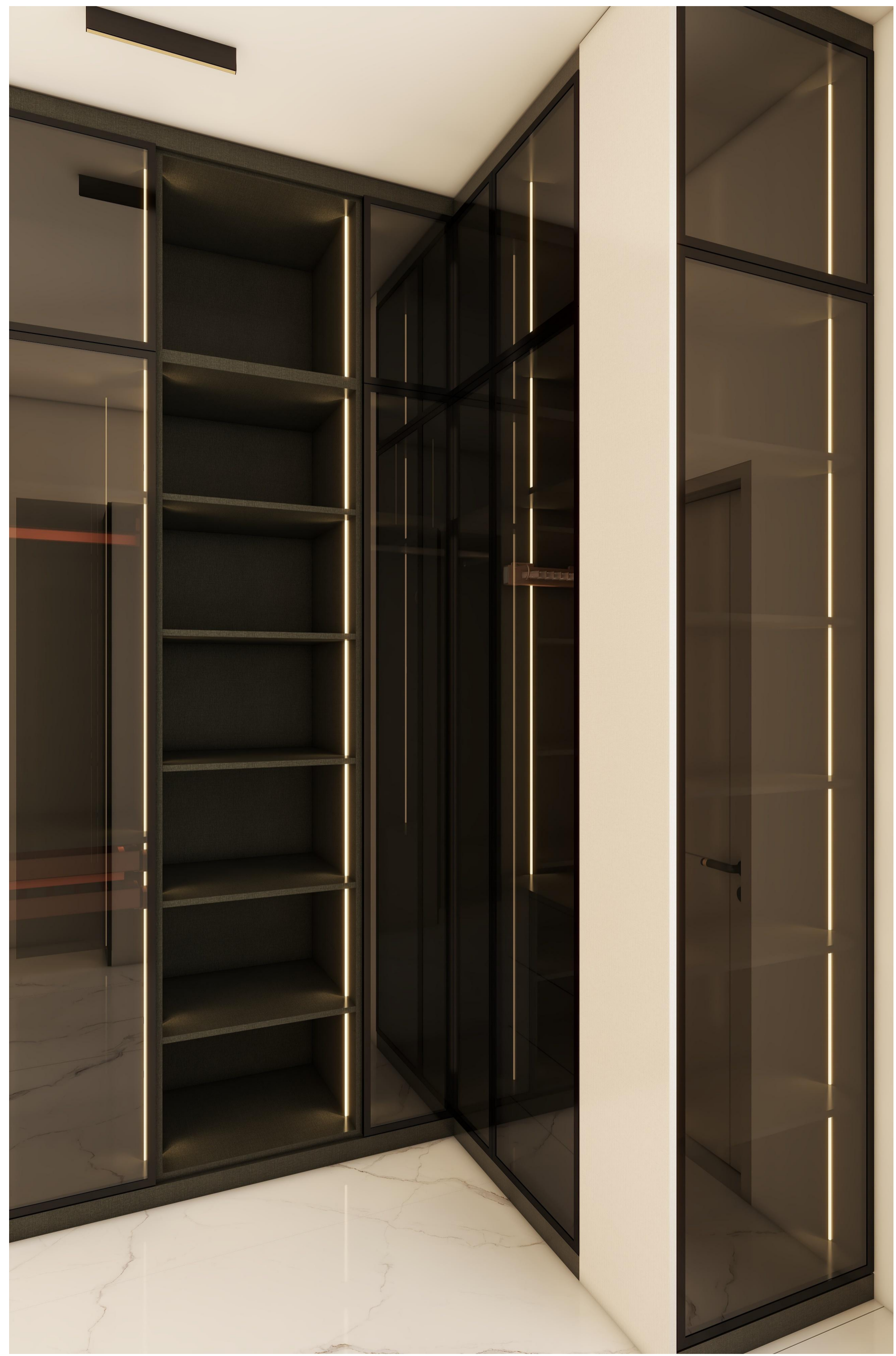

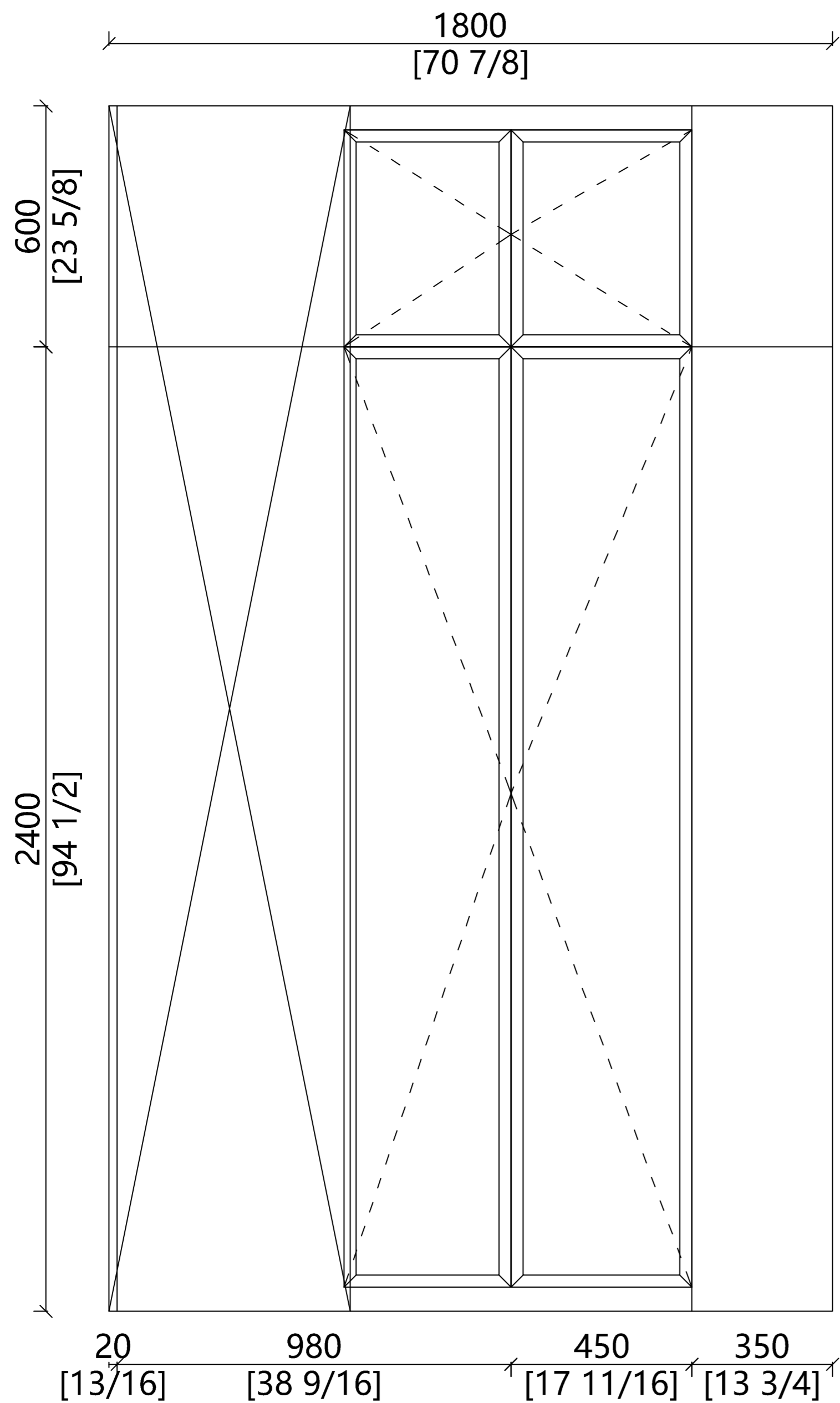

ELEVATION D

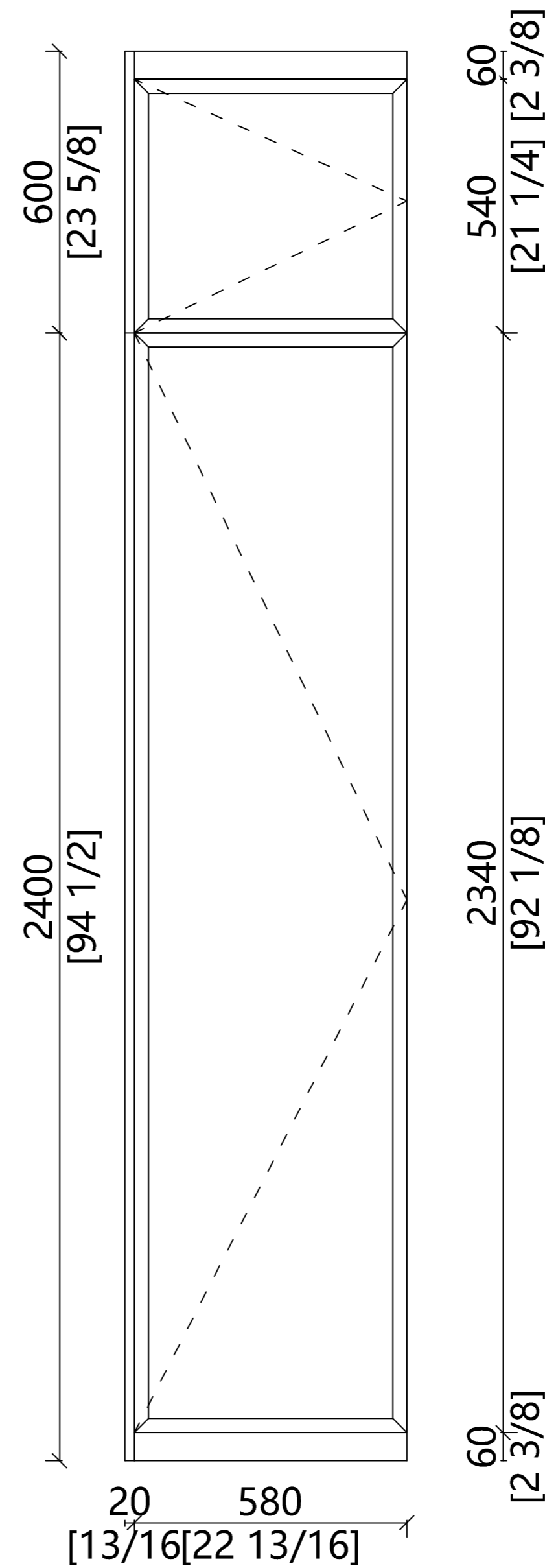
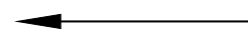

Order No: LEIUS20231123001A

Client Name: Shams

Email:

Client Address:

Room Space: Master room

Carcass

Material

Door

Material

Door

Shape

Drawer Handle:

Door Handle:

Remark:

Design Date:

Lead Time: 10-12 Weeks

Consignee:

Date:

Designer:

Tel:

Pages

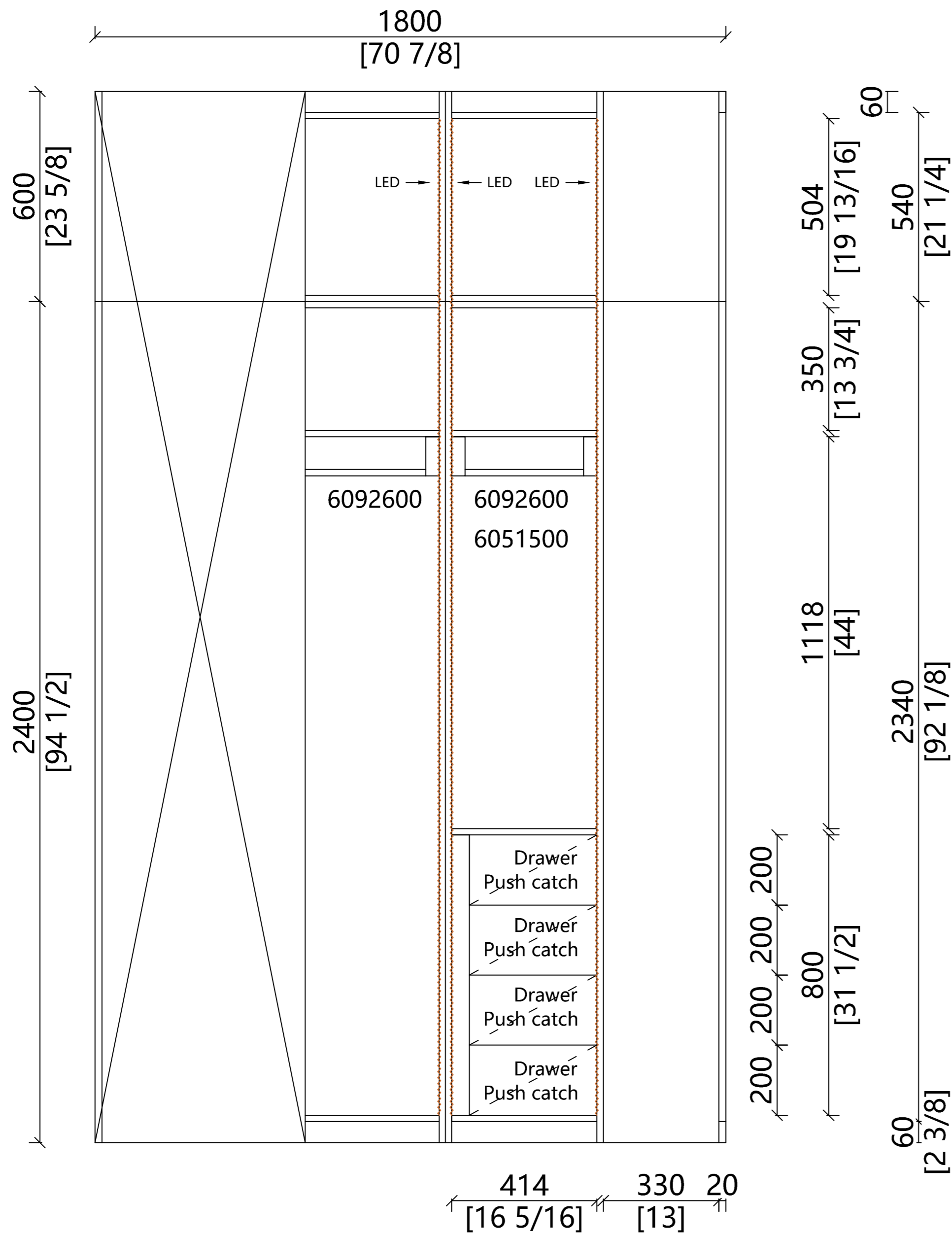

STRUCTURE D



Order No: LEIUS20231123001A	
Client Name: Shams	
Email:	
Client Address:	
Room Space: Master room	
Carcass Material	<input checked="" type="checkbox"/>
Door Material	<input type="checkbox"/>
Door Shape	<input checked="" type="checkbox"/>
Drawer Handle:	
Door Handle:	
Remark:	
Design Date:	
Lead Time: 10-12 Weeks	
Consignee:	
Date:	
Designer:	
Tel:	
Pages	

Showcase

Showcase



Carcase

Finish: MelamineBA2007
Material: Plywood(E0)
Thickness: 18mm/9 mm

柜体/多层板BA2007

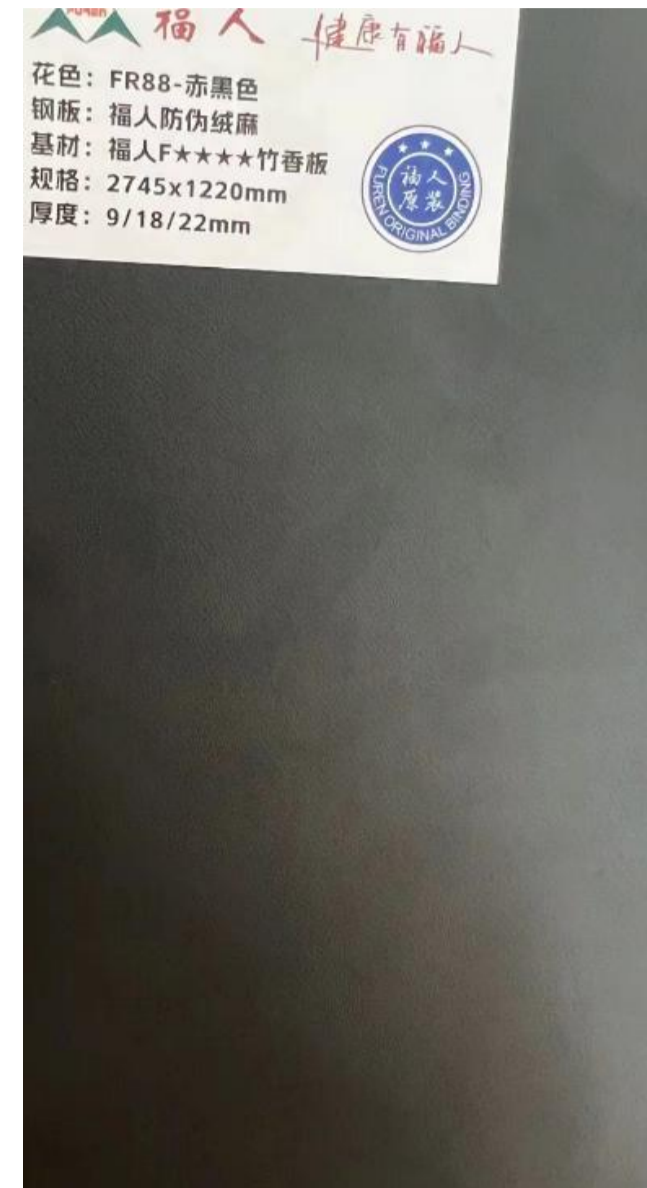

Partition

Finish: Melamine/black
Material: Plywood(E0)
Thickness: 18mm

层板用纯黑色/多层板



Aluminum Door

Frame:Black
Glass:Gray

铝框玻璃门
黑色边框/灰玻

Showcase



WAYMOVE





Order No: LEIUS20231123001A

Client Name: Shams

Email:

Client Address:

Room Space: Showcase

Carcass Material	
Door Material	
Door Shape	
	

Drawer Handle:

Door Handle:

Remark:

Design Date:

Lead Time: 10-12 Weeks

Consignee:

Date:

Designer:

Tel:

Pages

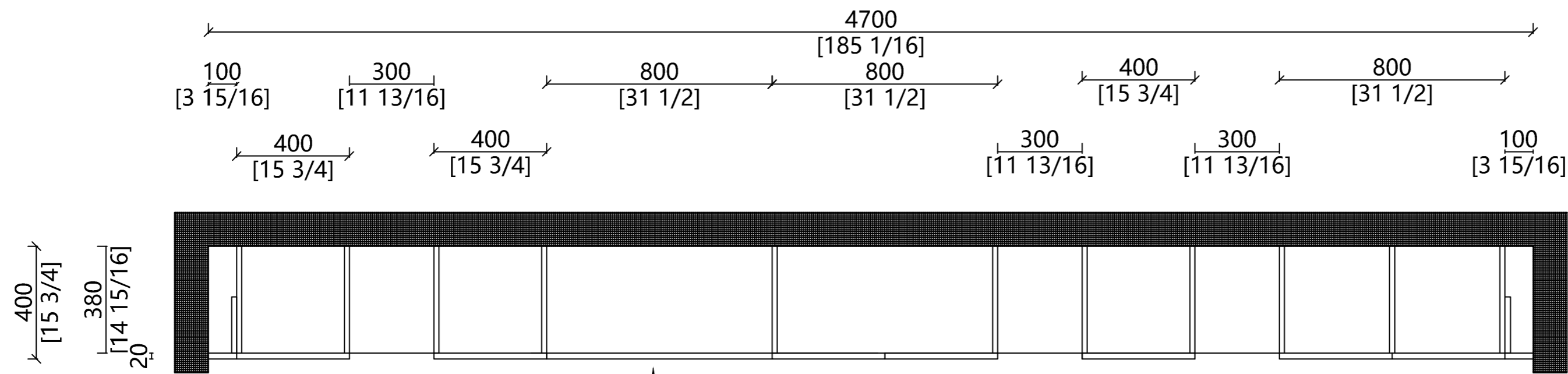

Fixed mirror

Plan

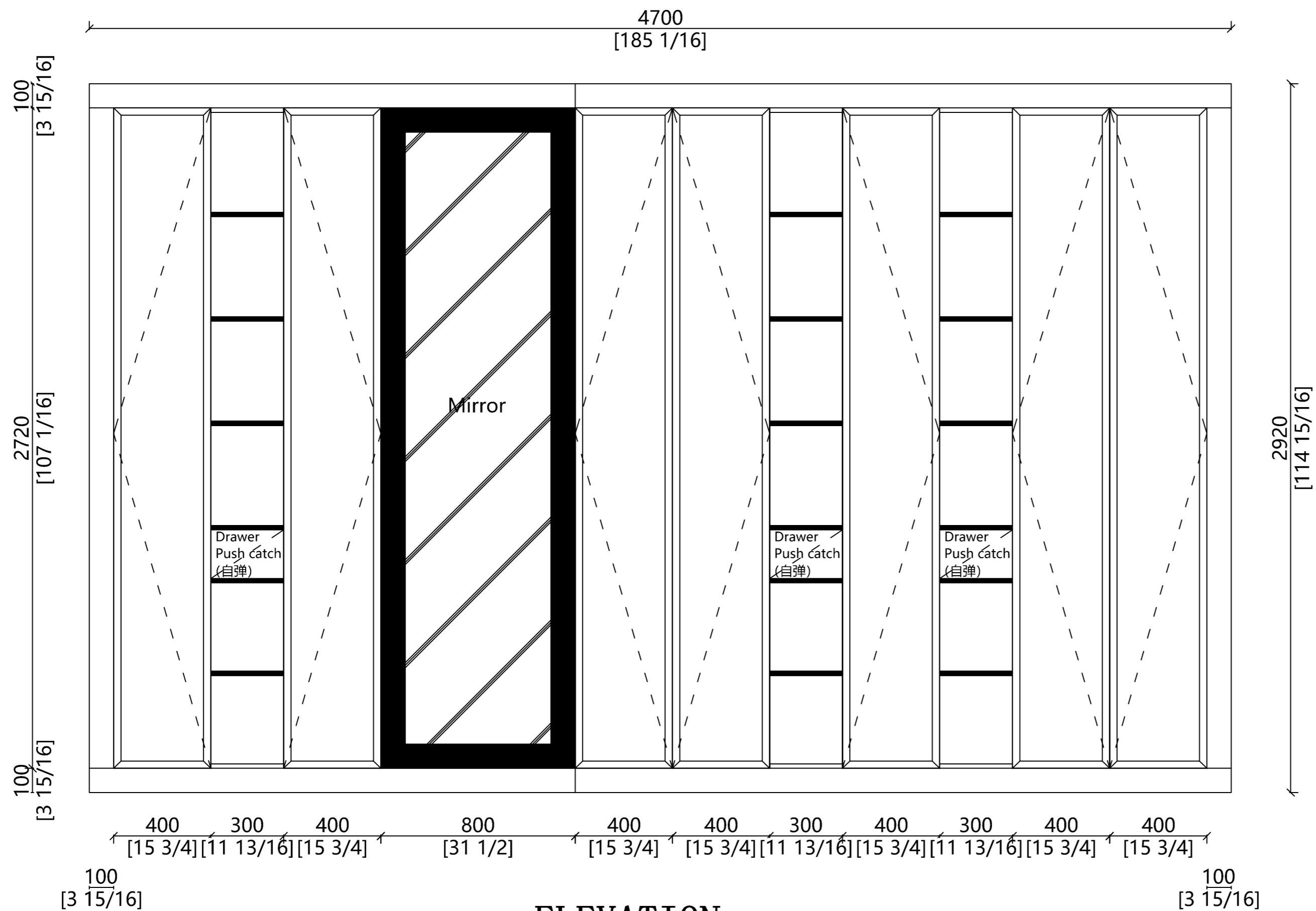

ELEVATION

LED is installed from the back panel
LED 4000K

LED灯带安装在背板前

WAYMOVE

4700
[185 1/16]

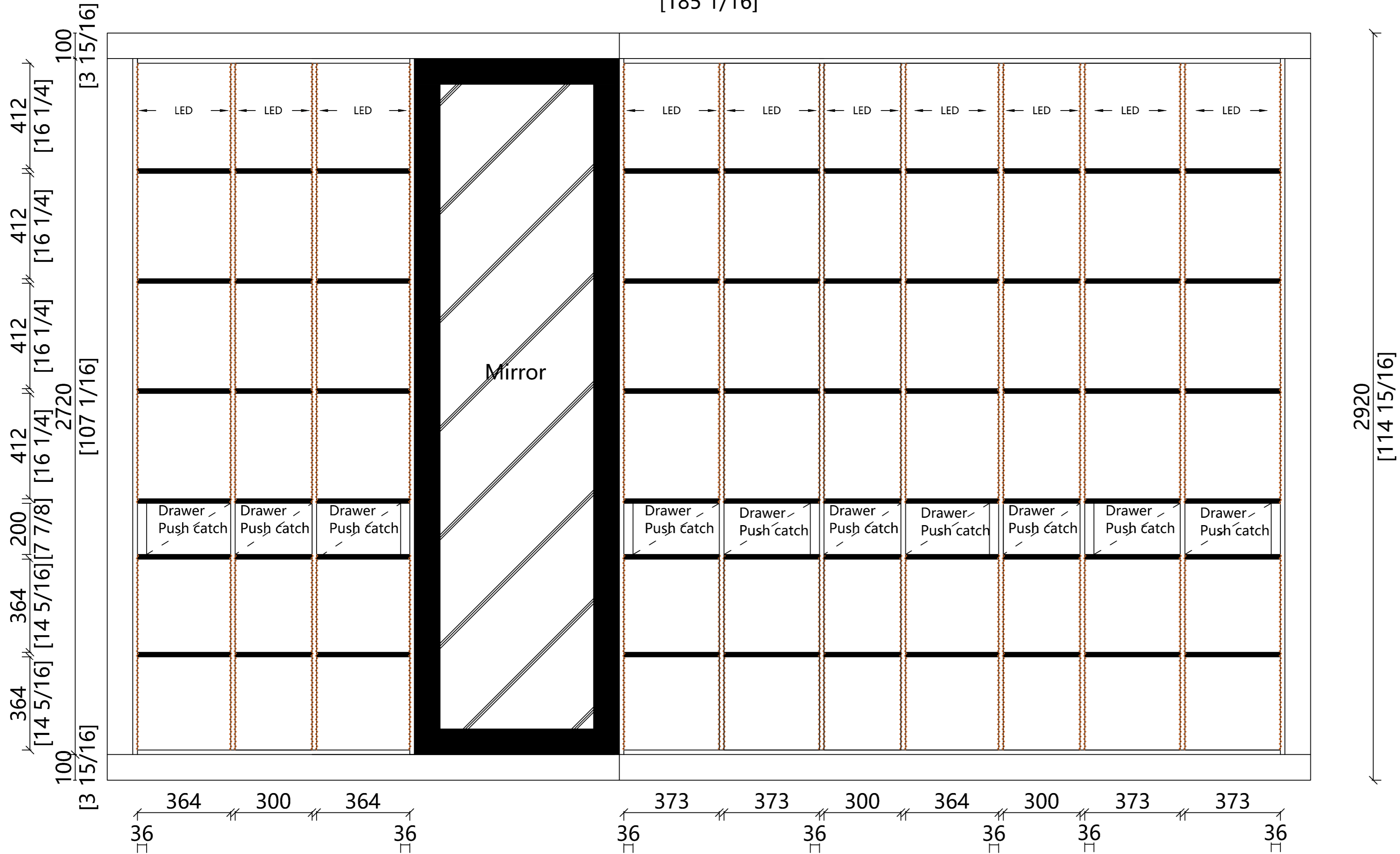

STRUCTURE

Order No: LEIUS20231123001A

Client Name: Shams

Email:

Client Address:

Room Space: Showcase

Carcass Material	<input checked="" type="checkbox"/>
Door Material	<input type="checkbox"/>
Door Shape	<input checked="" type="checkbox"/>

Drawer Handle:

Door Handle:

Remark:

Design Date:

Lead Time: 10-12 Weeks

Consignee:

Date:

Designer:

Tel:

Pages

Library



Carcase

Finish: MelamineTB9054
Material: Plywood(E0)
Thickness: 18mm/9 mm

柜体/多层板TB9054

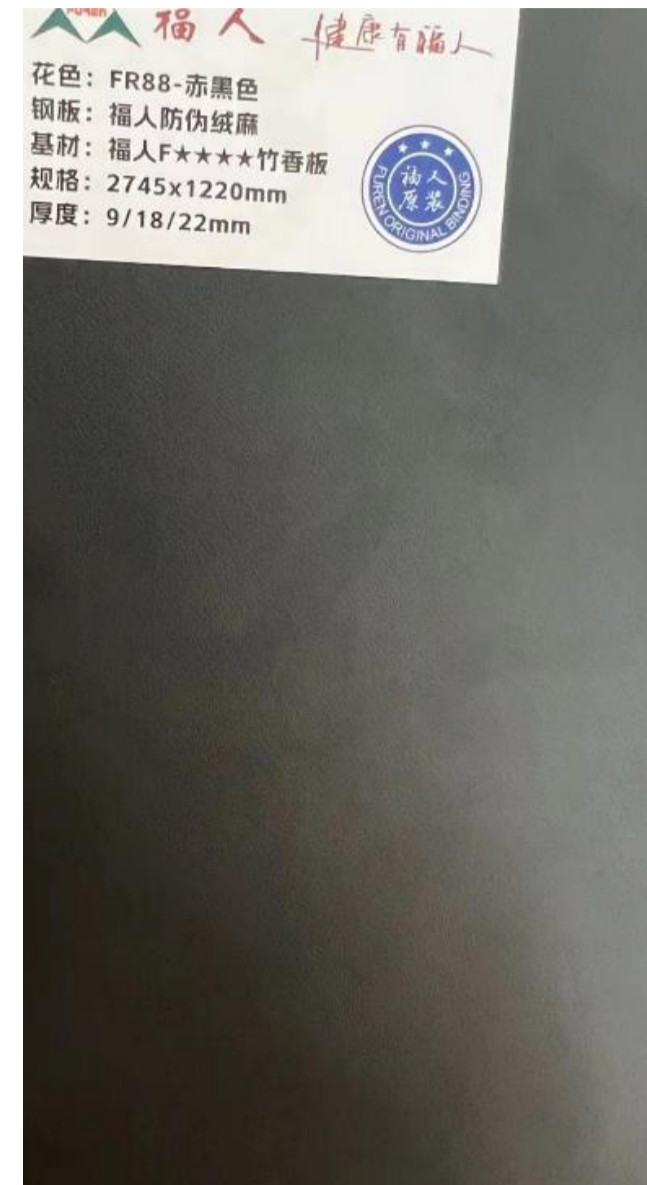

Partition

Finish: Melamine/black
Material: Plywood(E0)
Thickness: 18mm

层板用纯黑色/多层板



Aluminum Door

Frame:Black
Glass:Gray

铝框玻璃门
黑色边框/灰玻

Library



WAYMOVE

Order No: LEIUS20231123001A

Client Name: Shams

Email:

Client Address:

Room Space: Library

Carcass Material	<input checked="" type="checkbox"/>
Door Material	<input type="checkbox"/>
Door Shape	<input checked="" type="checkbox"/>

Drawer Handle:

Door Handle:

Remark:

Design Date:

Lead Time: 10-12 Weeks

Consignee:

Date:

Designer:

Tel:

Pages

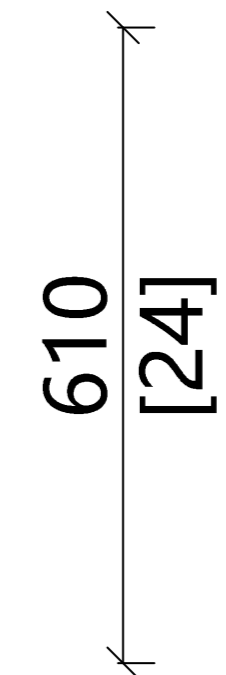
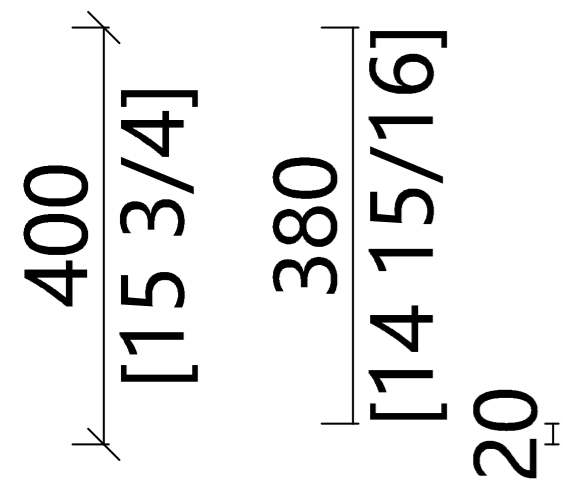
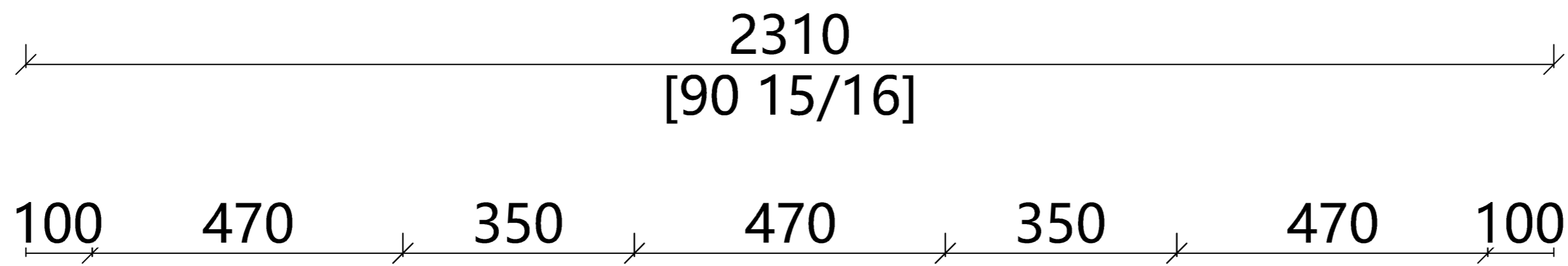

Plan

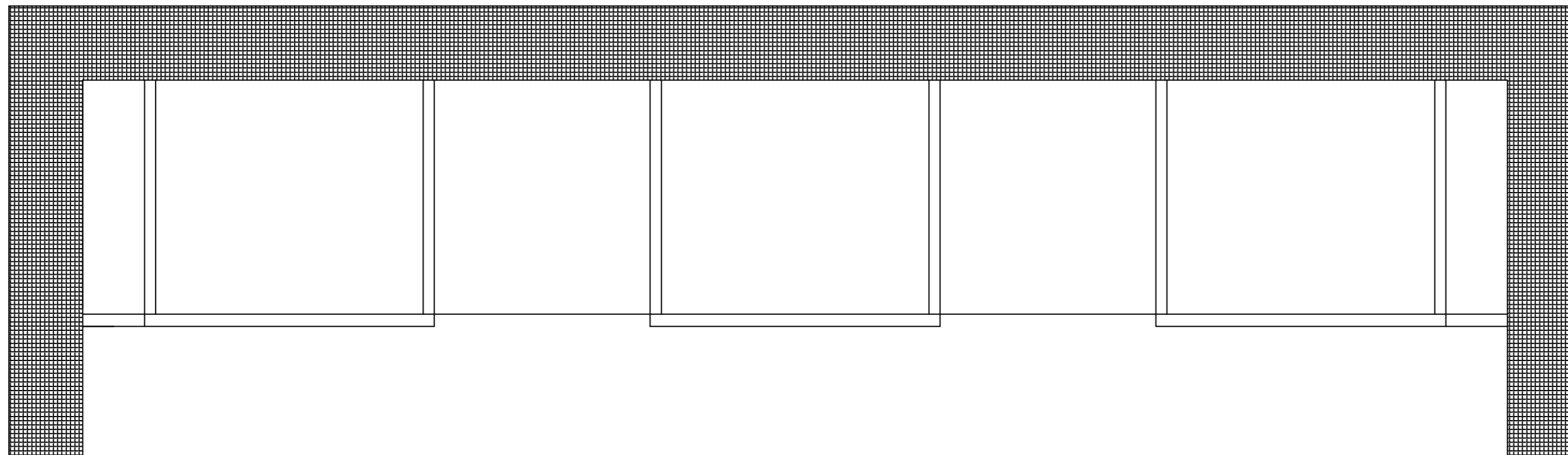

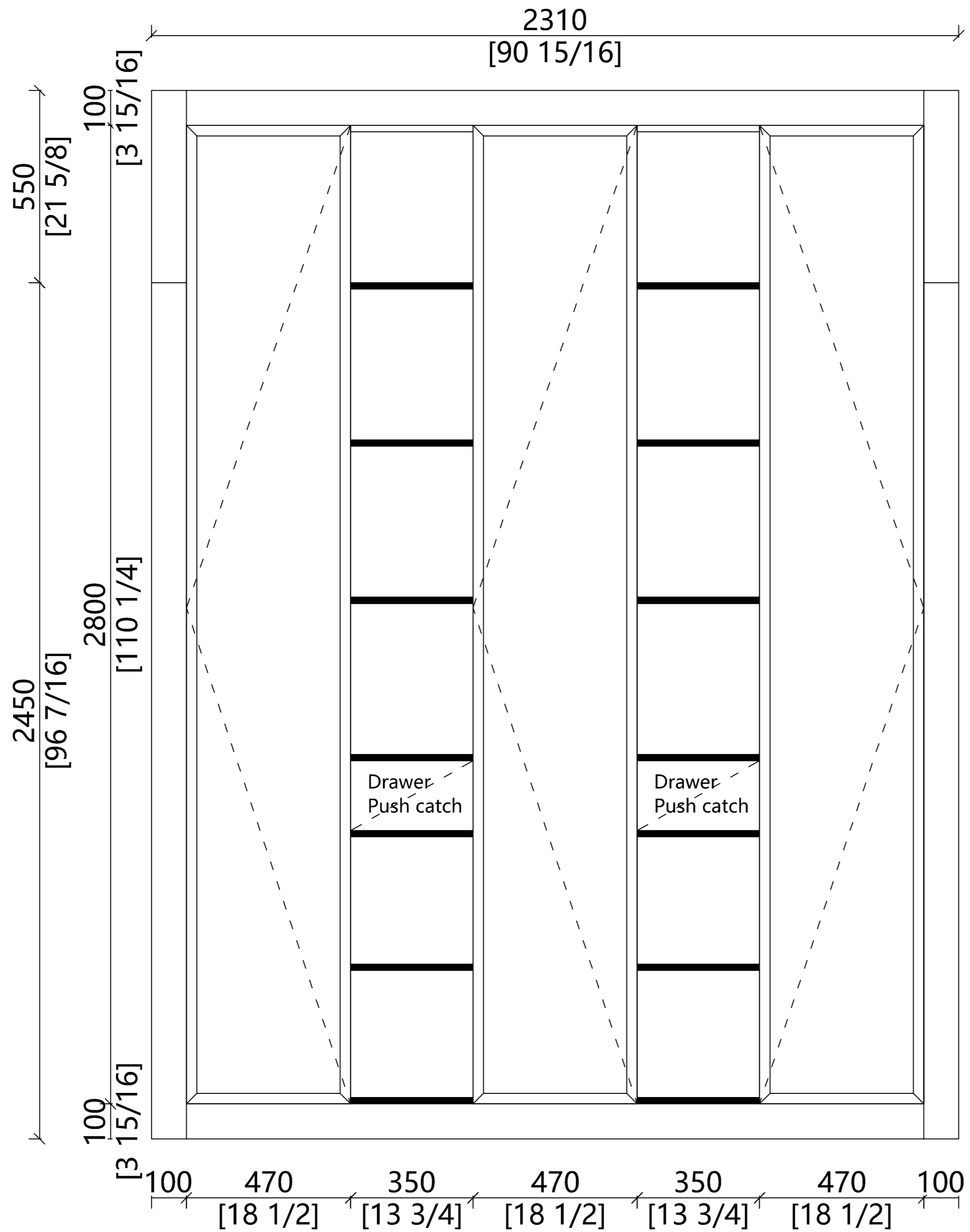

ELEVATION

WAYMOVE

Order No: LEIUS20231123001A

Client Name: Shams

Email:

Client Address:

Room Space: Library

Carcass

Material



Door

Material



Door

Shape



Drawer Handle:

Door Handle:

Remark:

Design Date:

Lead Time: 10-12 Weeks

Consignee:

Date:

Designer:

Tel:

Pages

LED is installed from the back panel
LED 4000K

LED灯带安装在背板前

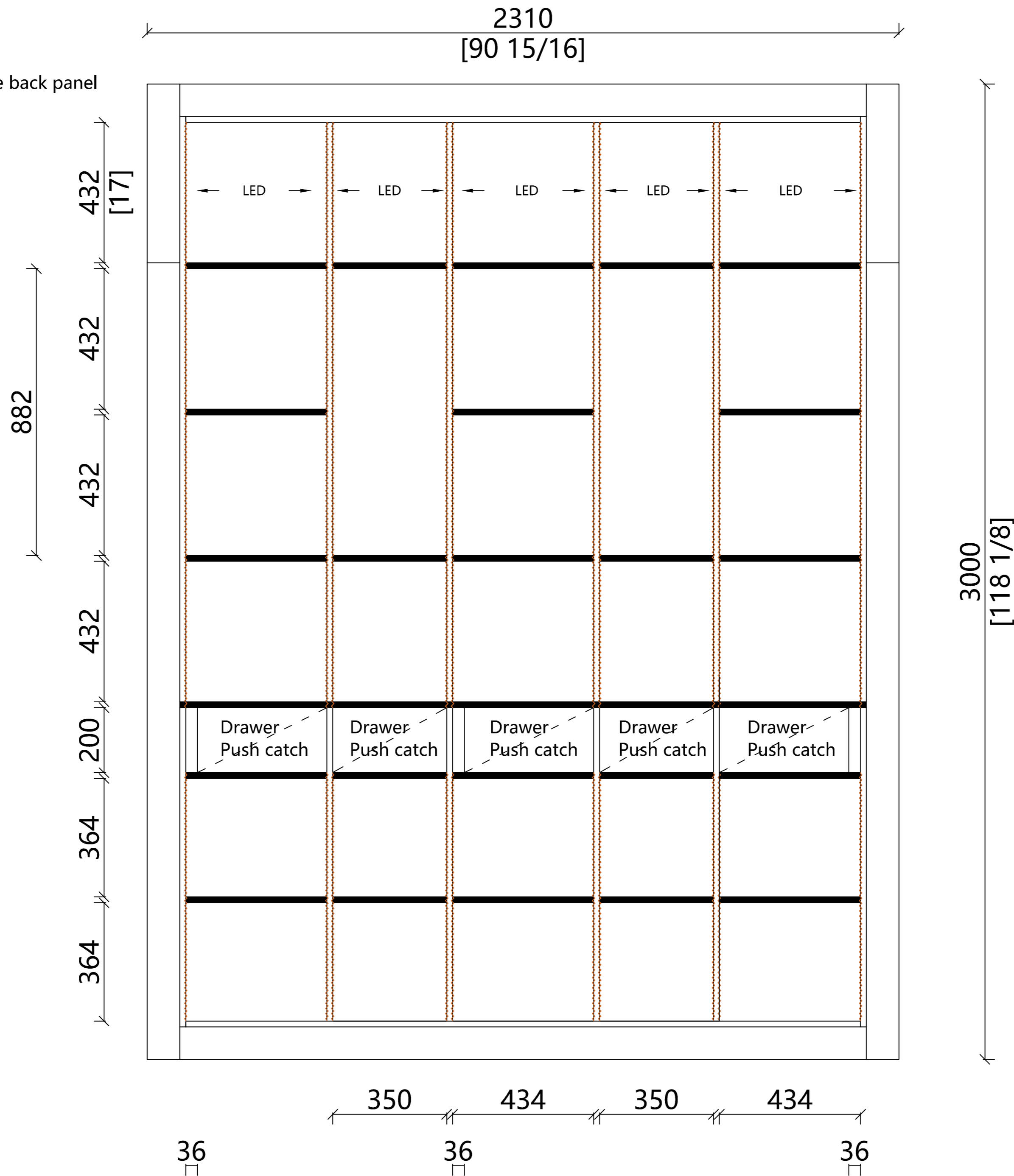

STRUCTURE

WAYMOVE

Order No: LEIUS20231123001A

Client Name: Shams

Email:

Client Address:

Room Space: Library

Carcass	
Material	<input checked="" type="checkbox"/>
Door	<input type="checkbox"/>
Material	<input checked="" type="checkbox"/>
Door	<input checked="" type="checkbox"/>
Shape	<input type="checkbox"/>

Drawer Handle:

Door Handle:

Remark:

Design Date:

Lead Time: 10-12 Weeks

Consignee:

Date:

Designer:

Tel:

Pages

Laundry 1&Laundry 2

Laundry 1&Laundry 2



Carcase

Finish: MelamineDY1012
Material: Plywood(E0)
Thickness: 18mm/9 mm

柜体/多层板DY1012

Door/End panel

Finish: PaintedDY1012
Material: HDF
Thickness: 18mm

油漆门DY1012



Handle:M524

Length:160MM
Material:zinc alloy
Finish:Matte Black

铭洲拉手M524
160mm/哑黑

Laundry 1

Laundry 1



3090005
WASTE BIN



WALL
IRONING BOARD



3072004A
SIDE BASKET

WAYMOVE

Order No: LEIUS20231123001A

Client Name: Shams

Email:

Client Address:

Room Space: Laundry 1

Carcass Material	<input checked="" type="checkbox"/>
Door Material	<input type="checkbox"/>
Door Shape	<input checked="" type="checkbox"/>

Drawer Handle:

Door Handle:

Remark:

Design Date:

Lead Time: 10-12 Weeks

Consignee:

Date:

Designer:

Tel:

Pages

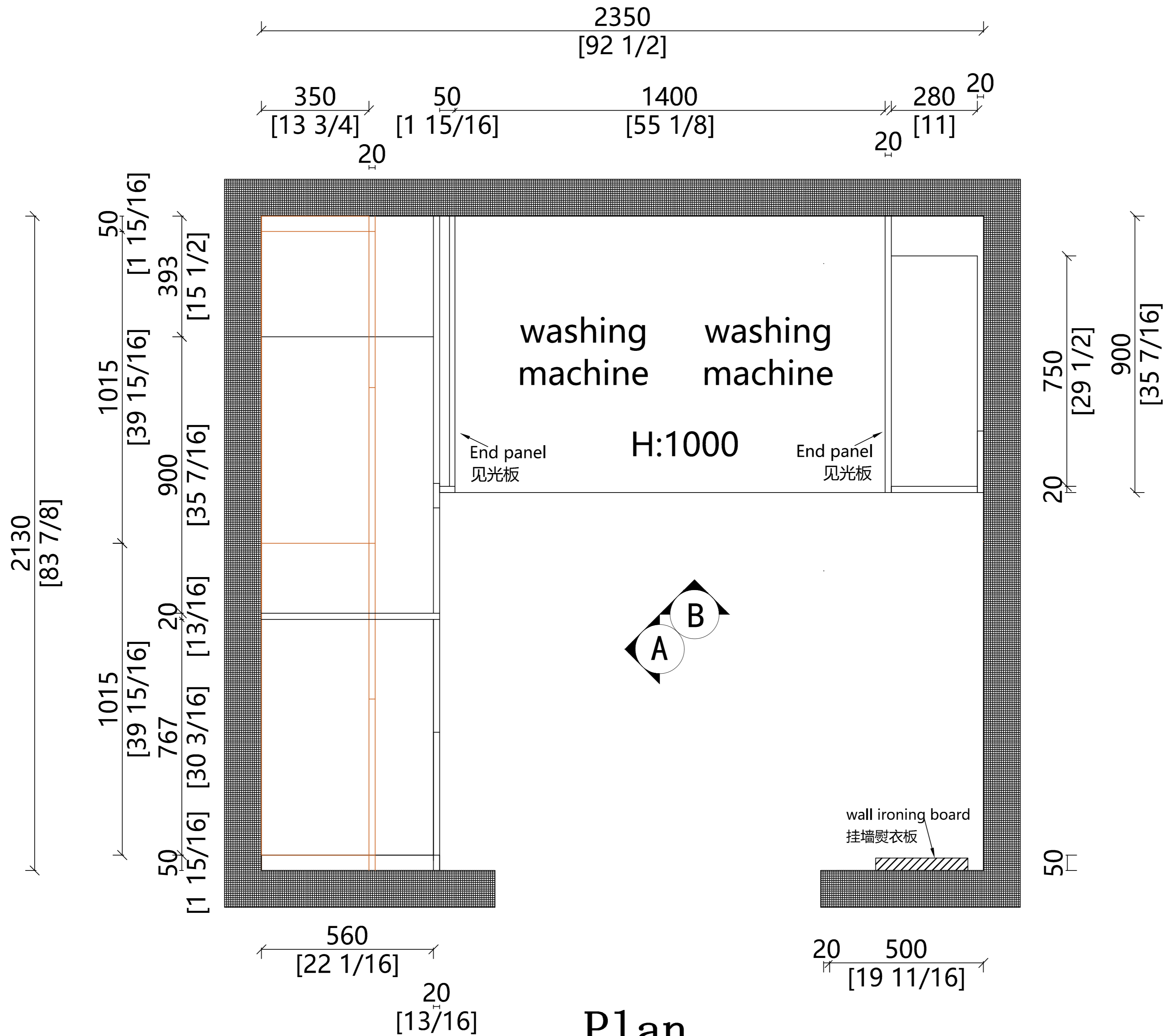

WAYMOVE

Order No: LEIUS20231123001A

Client Name: Shams

Email:

Client Address:

Room Space: Laundry 1

Carcass

Material



Door



Material



Door



Shape



Drawer Handle:

Door Handle:

Remark:

Design Date:

Lead Time: 10-12 Weeks

Consignee:

Date:

Designer:

Tel:

Pages

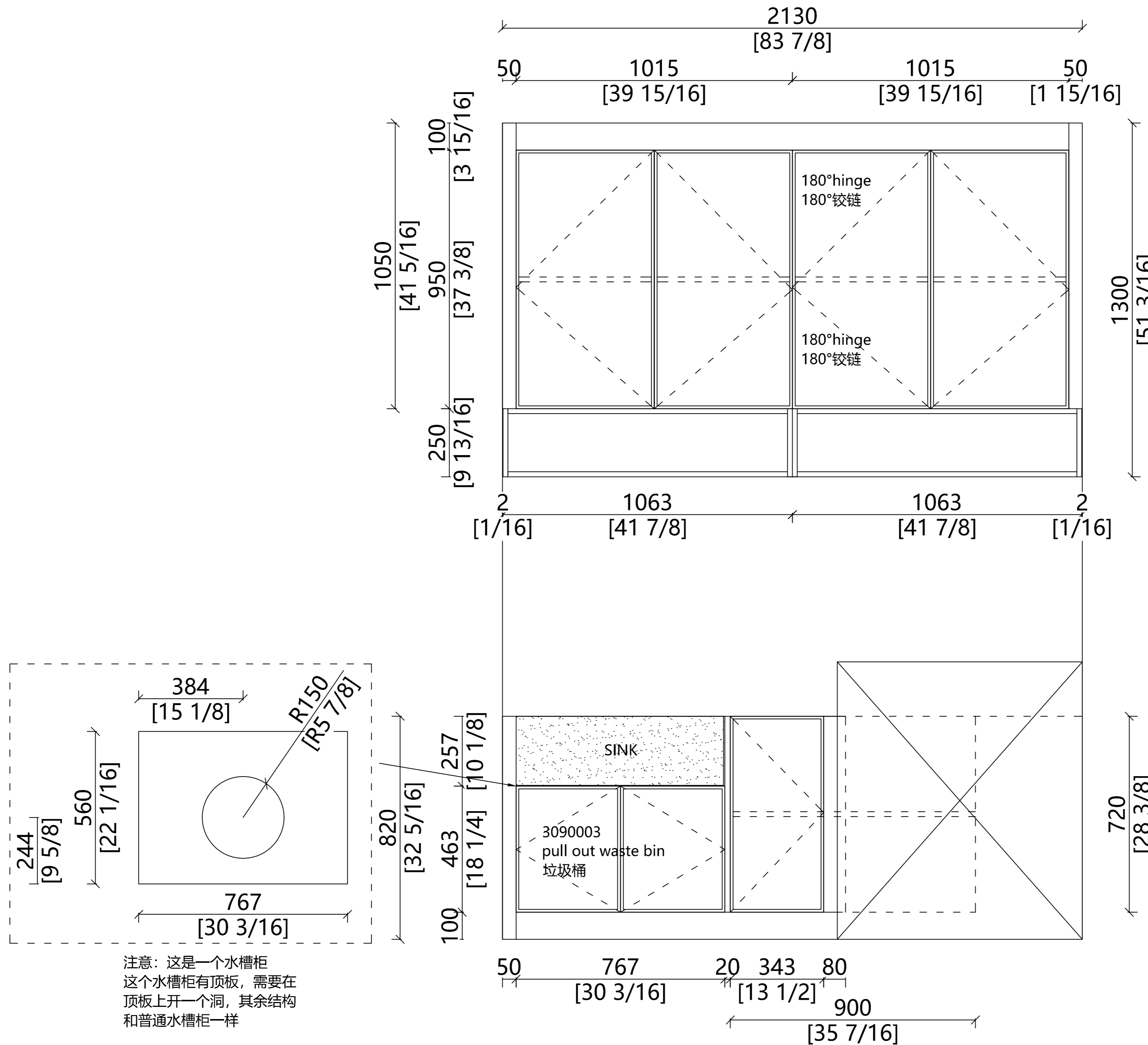

注意：这是一个水槽柜
这个水槽柜有顶板，需要在
顶板上开一个洞，其余结构
和普通水槽柜一样

ELEVATION A

WAYMOVE

Order No: LEIUS20231123001A

Client Name: Shams

Email:

Client Address:

Room Space: Laundry 1

Carcass	
Material	
Door	<input type="checkbox"/>
Material	
Door	<input checked="" type="checkbox"/>
Shape	<input type="checkbox"/>

Drawer Handle:

Door Handle:

Remark:

Design Date:

Lead Time: 10-12 Weeks

Consignee:

Date:

Designer:

Tel:

Pages

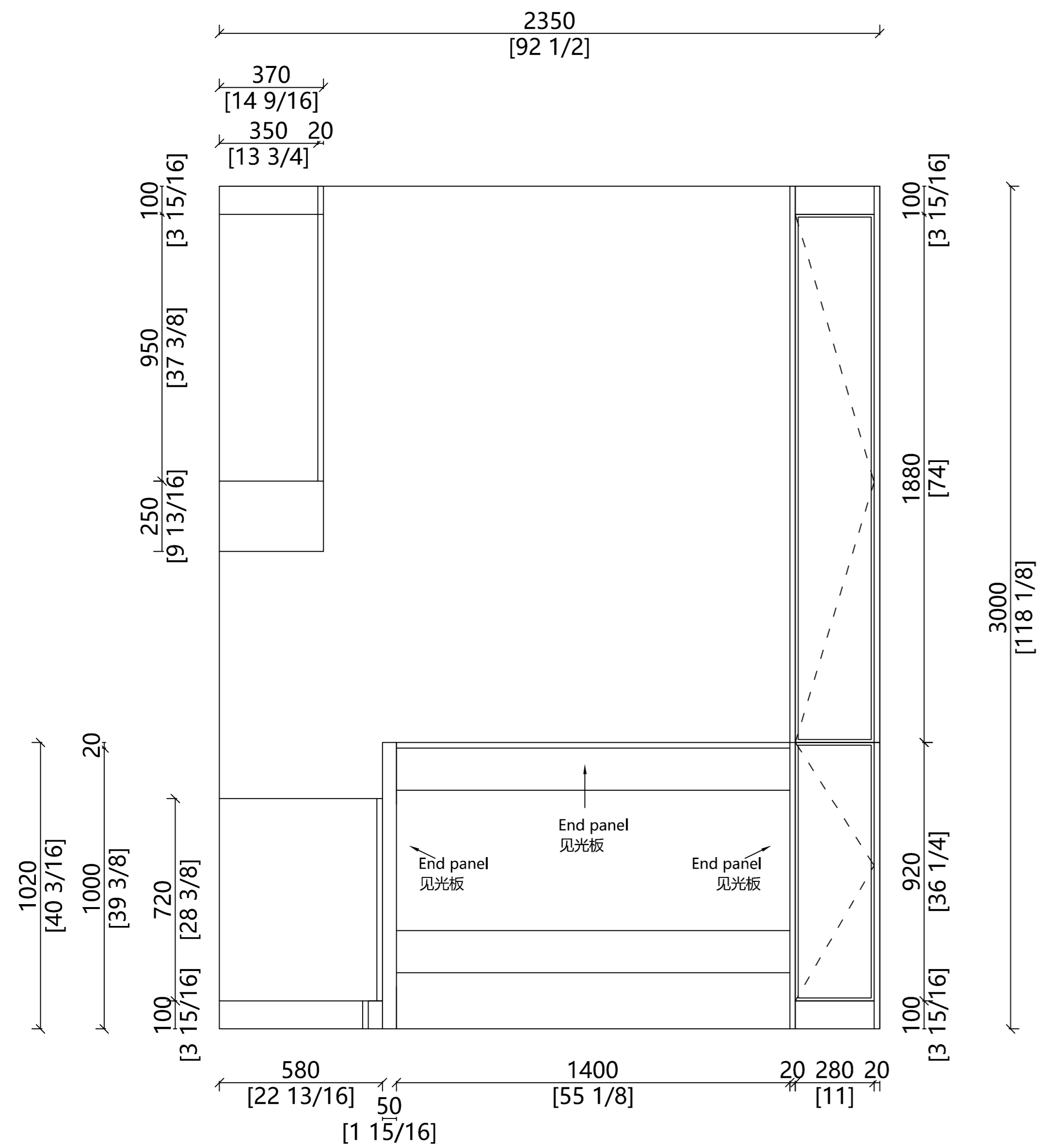

ELEVATION B

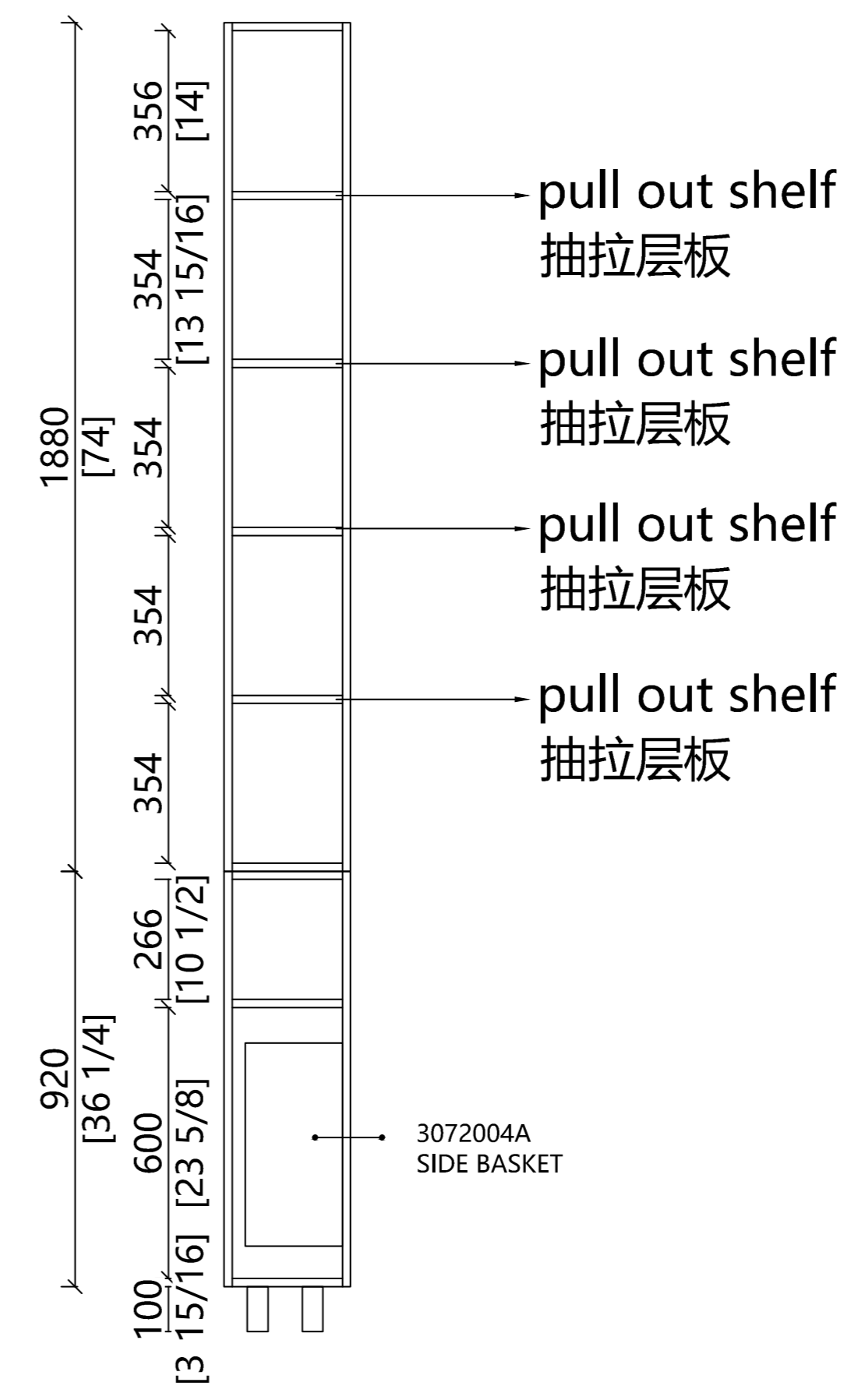

Laundry 2

Laundry 1



pull-out ironing board



pull-out waste bin

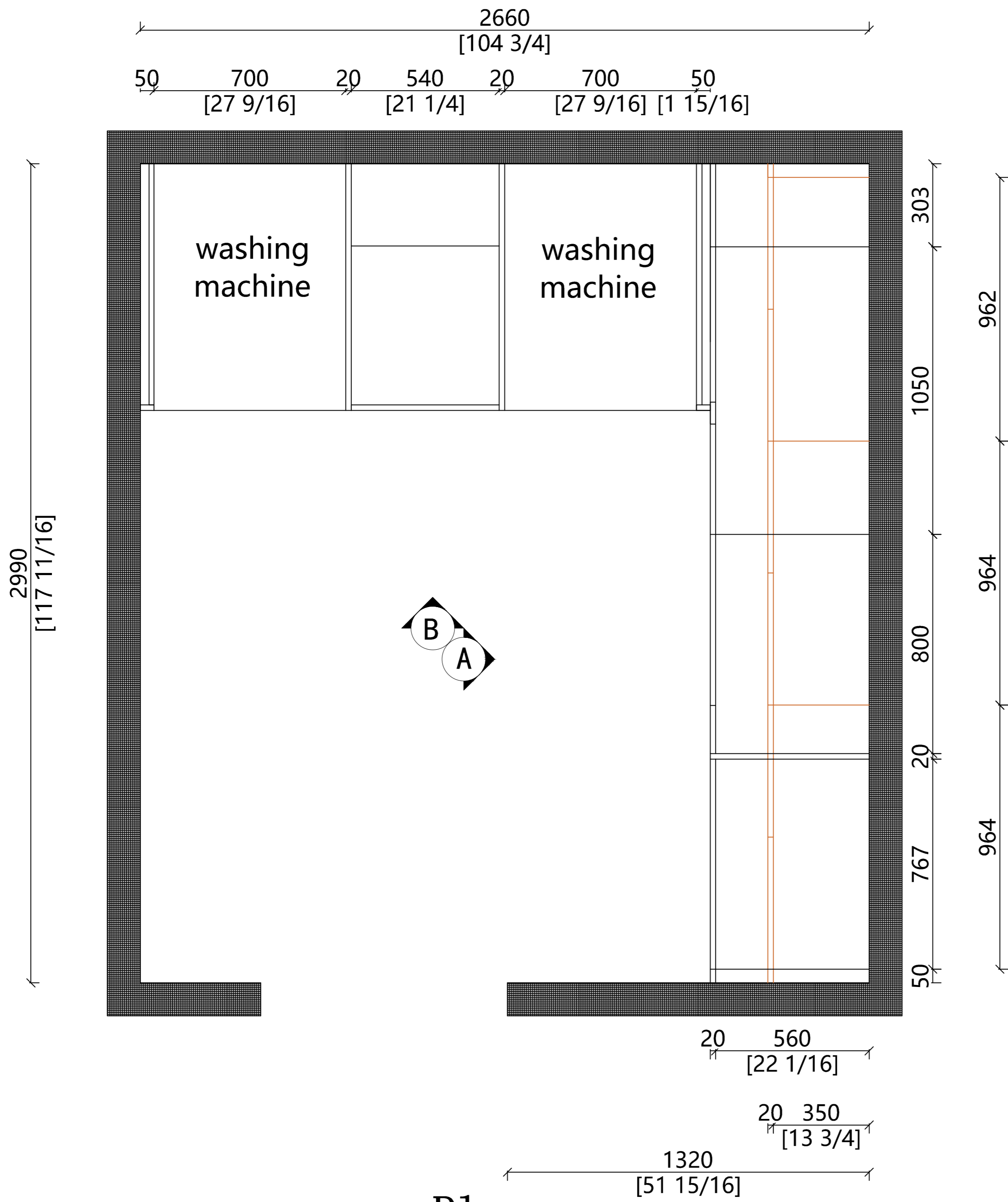

Plan



Order No: LEIUS20231123001A	
Client Name: Shams	
Email:	
Client Address:	
Room Space: Laundry 2	
Carcass	
Material	
Door	
Material	
Door	
Shape	
Drawer Handle:	
Door Handle:	
Remark:	
Design Date:	
Lead Time: 10-12 Weeks	
Consignee:	
Date:	
Designer:	
Tel:	
Pages	



Order No: LEIUS20231123001A

Client Name: Shams

Email:

Client Address:

Room Space: Laundry 2

Carcass	
Material	
Door	<input type="checkbox"/>
Material	
Door	
Shape	<input type="checkbox"/>

Drawer Handle:

Door Handle:

Remark:

Design Date:

Lead Time: 10-12 Weeks

Consignee:
Date:

Designer:
Tel:

Pages

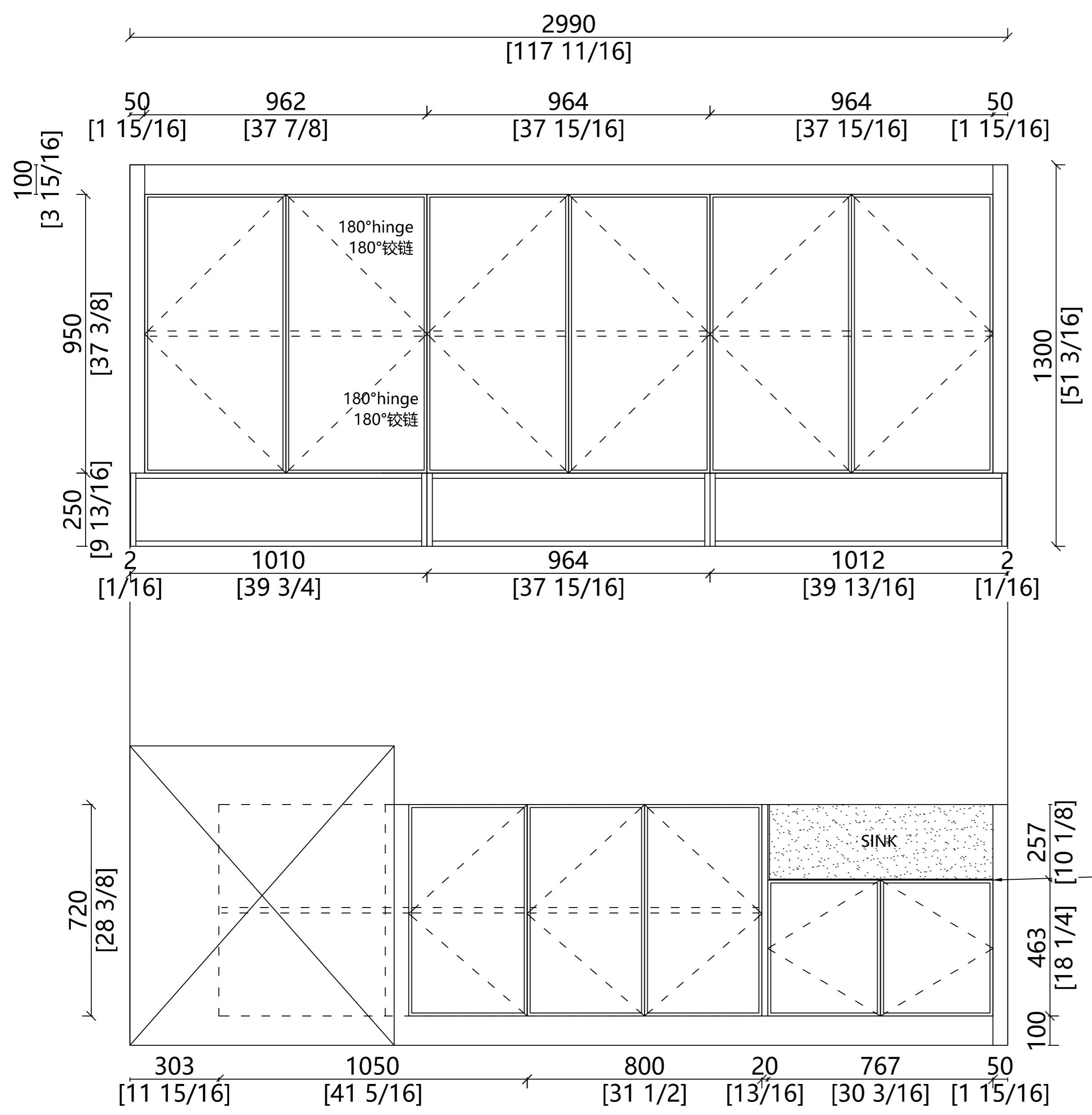

注意：这是一个水槽柜
这个水槽柜有顶板，需要在
顶板上开一个洞，其余结构
和普通水槽柜一样

ELEVATION A

Living room

Living room



Carcase

Finish: MelamineDY1017
Material: Plywood(E0)
Thickness: 18mm/9 mm

柜体/多层板DY1017

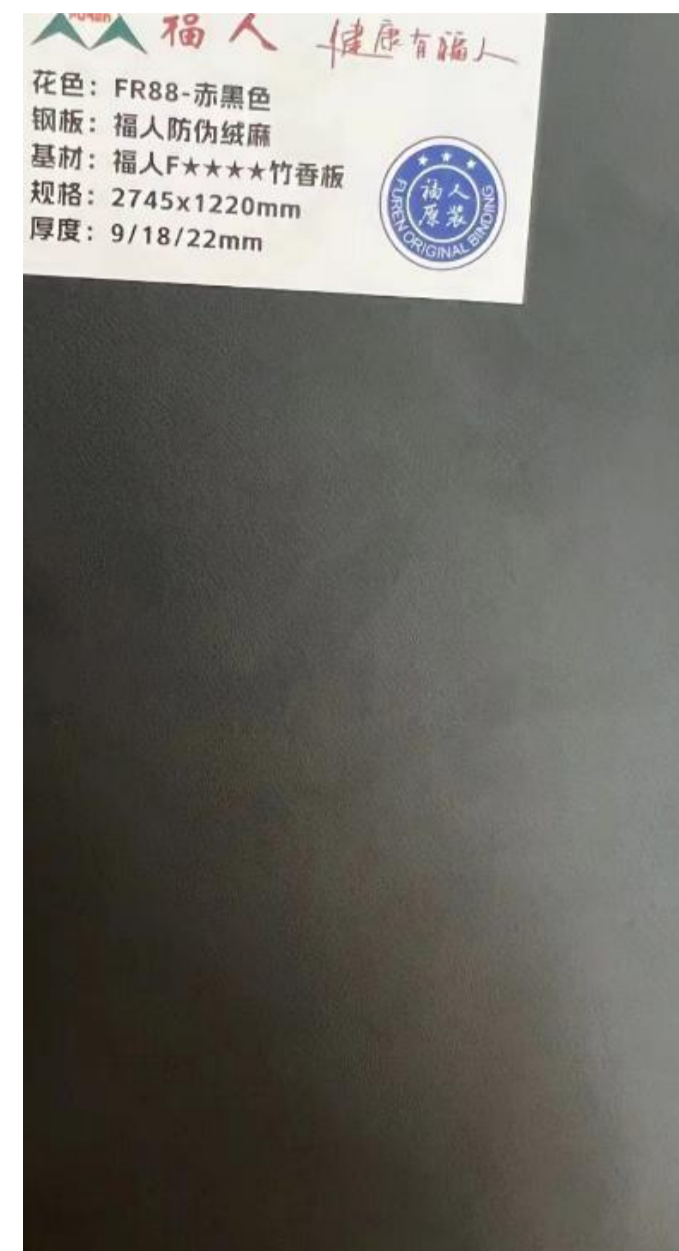

Partition

Finish: Melamine/black
Material: Plywood(E0)
Thickness: 18mm

层板用纯黑色/多层板



Aluminum Door

Frame:Black
Glass:Gray

铝框玻璃门
黑色边框/灰玻

Living room



WAYMOVE

Order No: LEIUS20231123001A

Client Name: Shams

Email:

Client Address:

Room Space: Living space

Carcass Material	<input checked="" type="checkbox"/>
Door Material	<input checked="" type="checkbox"/>
Door Shape	<input checked="" type="checkbox"/>

Drawer Handle:

Door Handle:

Remark:

Design Date:

Lead Time: 10-12 Weeks

Consignee:

Date:

Designer:

Tel:

Pages

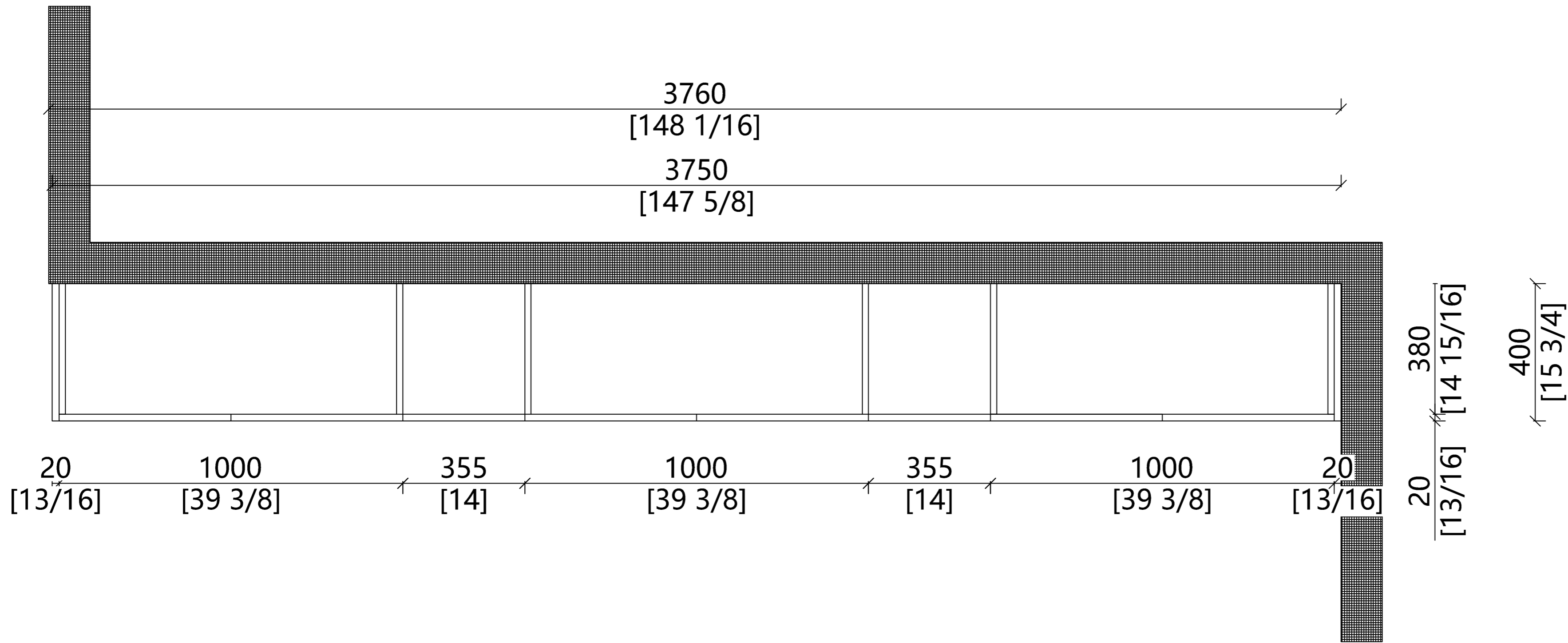

Plan

WAYMOVE

Order No: LEIUS20231123001A

Client Name: Shams

Email:

Client Address:

Room Space: Living space

Carcass

Material



Door



Material



Door



Shape



Drawer Handle:

Door Handle:

Remark:

Design Date:

Lead Time: 10-12 Weeks

Consignee:

Date:

Designer:

Tel:

Pages

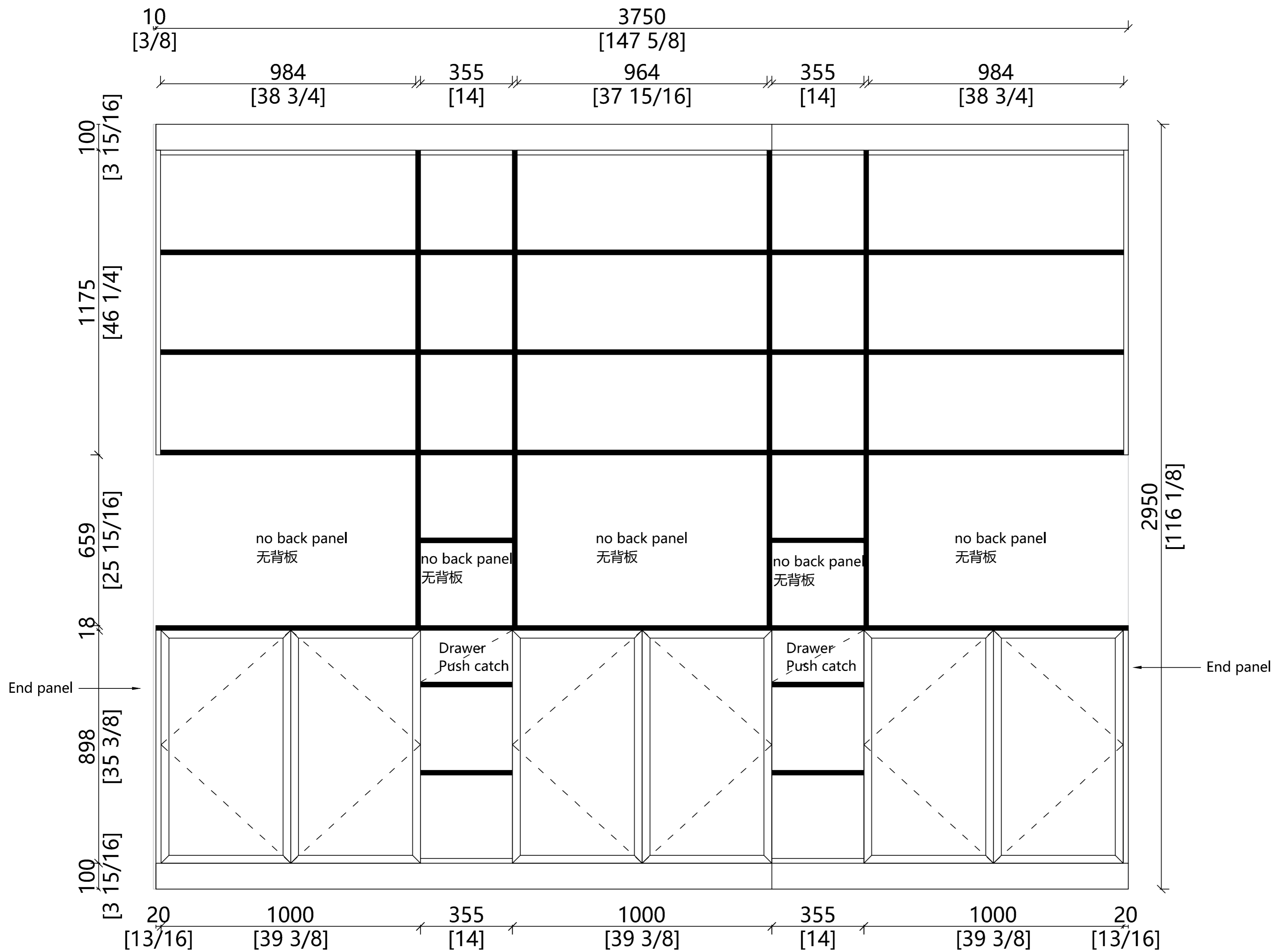

ELEVATION

WAYMOVE

Order No: LEIUS20231123001A

Client Name: Shams

Email:

Client Address:

Room Space: Living space

Carcass

Material



Door



Material



Door



Shape



Drawer Handle:

Door Handle:

Remark:

Design Date:

Lead Time: 10-12 Weeks

Consignee:

Date:

Designer:

Tel:

Pages

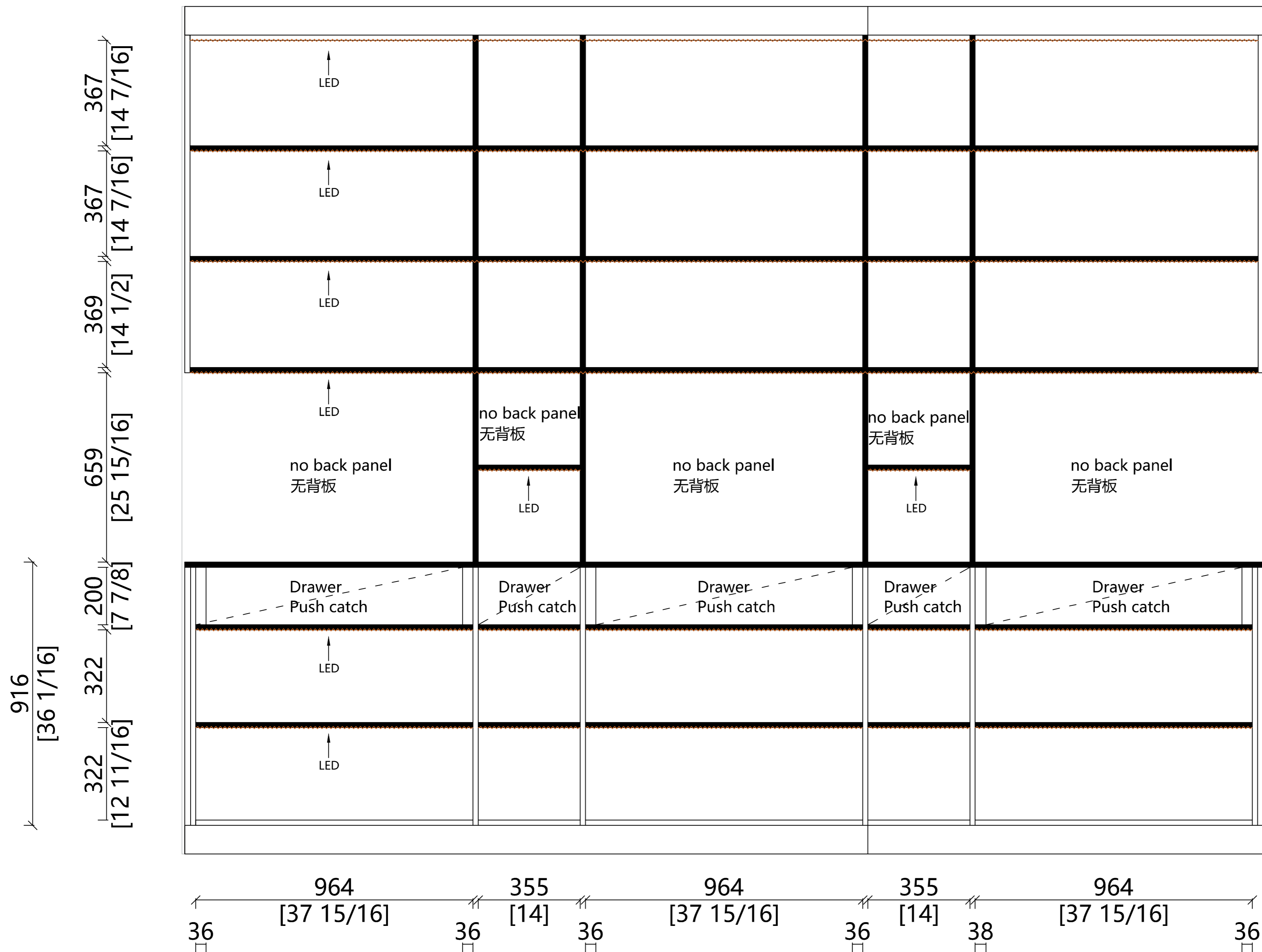

STRUCTURE

A/Z/S/K/O Closet

A/Z/S/K/O Closet



Carcase

Finish: Melamine RA1090
Material: Plywood(E0)
Thickness: 18mm/9 mm

柜体和辅助板
多层板RA1090

Door:

Finish: Painted/RA1090
Material: HDF
Thickness: 18mm

门板
油漆颜色同RA1090
门板边框50mm



Door

Handle: M1061
Length: 150MM
Material: zinc alloy
Finish: Matte Black

门板
铭洲拉手M1061
150mm/哑黑

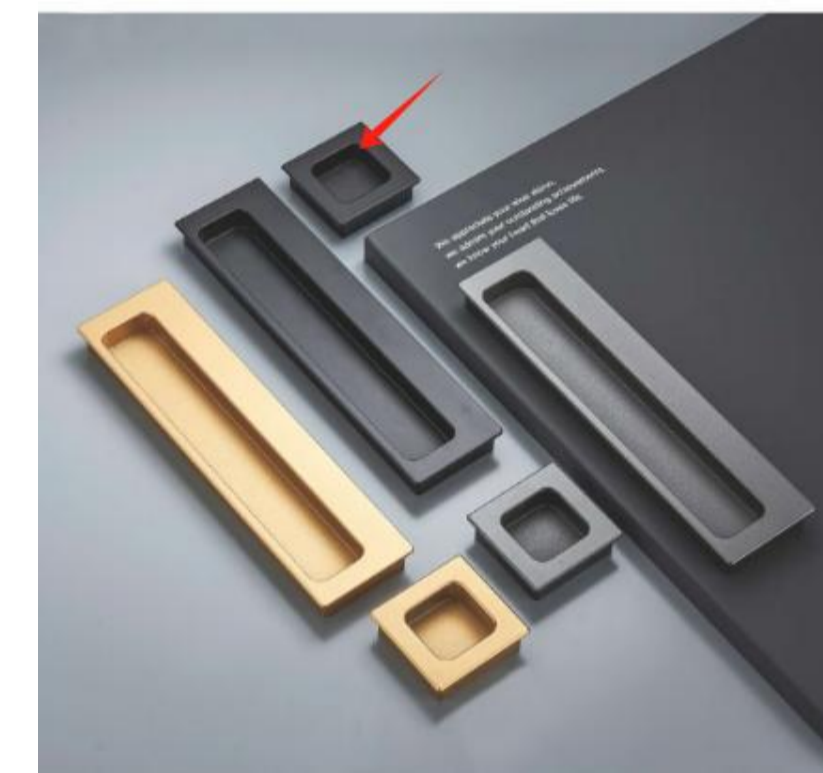

Drawer

Handle: M1109
Length: 50MM
Material: zinc alloy
Finish: Matte Black

抽屉
铭洲拉手M1109
50mm/哑黑



6112600
HANGING ROD/HANGING ROD
BASE (TRAPEZOID)

挂衣杆: 6112600

A Closet



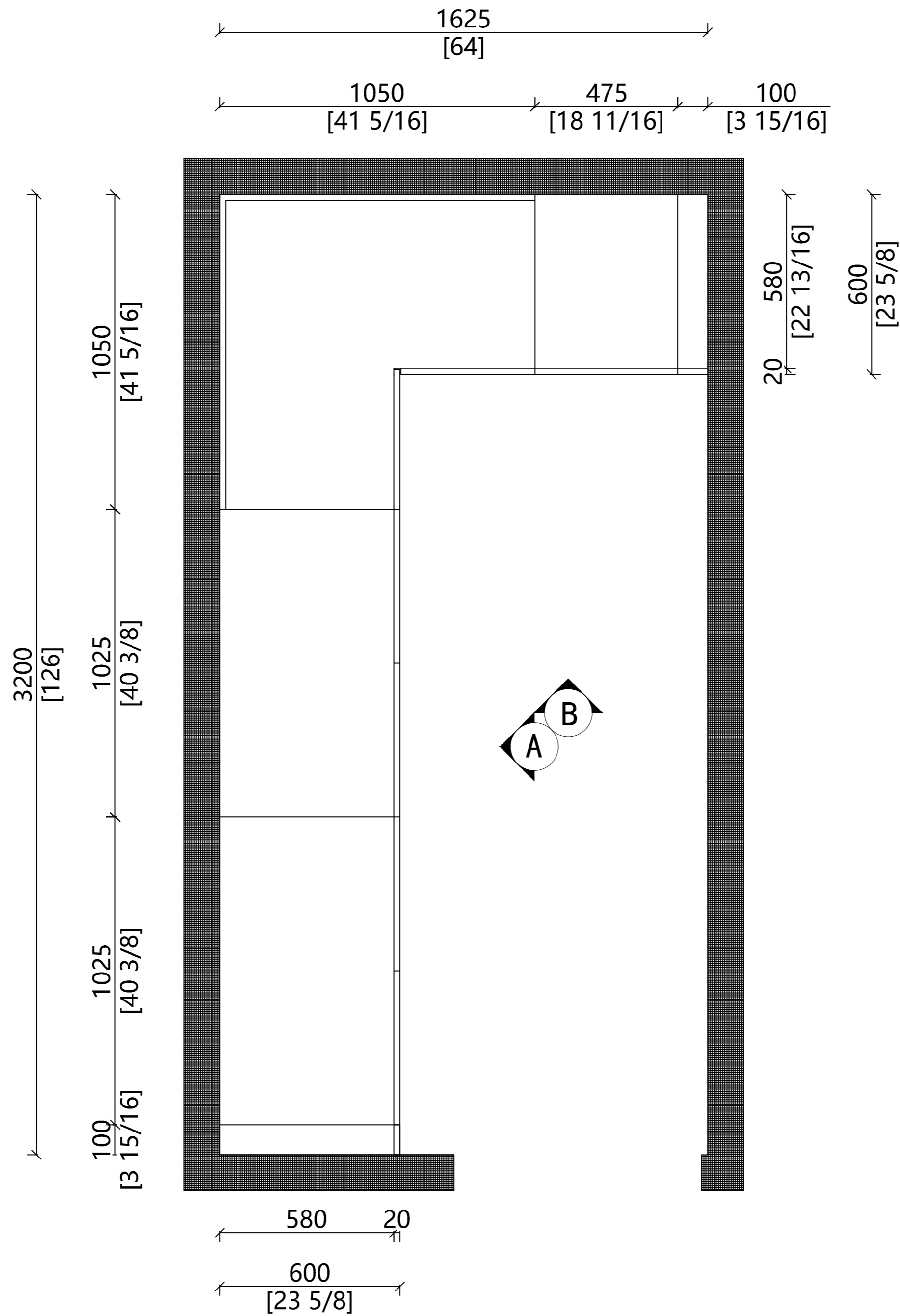

Plan

WAYMOVE

Order No: LEIUS20231123001A

Client Name: Shams

Email:

Client Address:

Room Space: A closet

Carcass	
Material	
Door	<input type="checkbox"/>
Material	
Door	<input checked="" type="checkbox"/>
Shape	<input type="checkbox"/>

Drawer Handle:

Door Handle:

Remark:

Design Date:

Lead Time: 10-12 Weeks

Consignee:

Date:

Designer:

Tel:

Pages

WAYMOVE

Order No: LEIUS20231123001A

Client Name: Shams

Email:

Client Address:

Room Space: A closet

Carcass	
Material	■
Door	□
Material	■
Door	⊗
Shape	□

Drawer Handle:

Door Handle:

Remark:

Design Date:

Lead Time: 10-12 Weeks

Consignee:

Date:

Designer:

Tel:

Pages

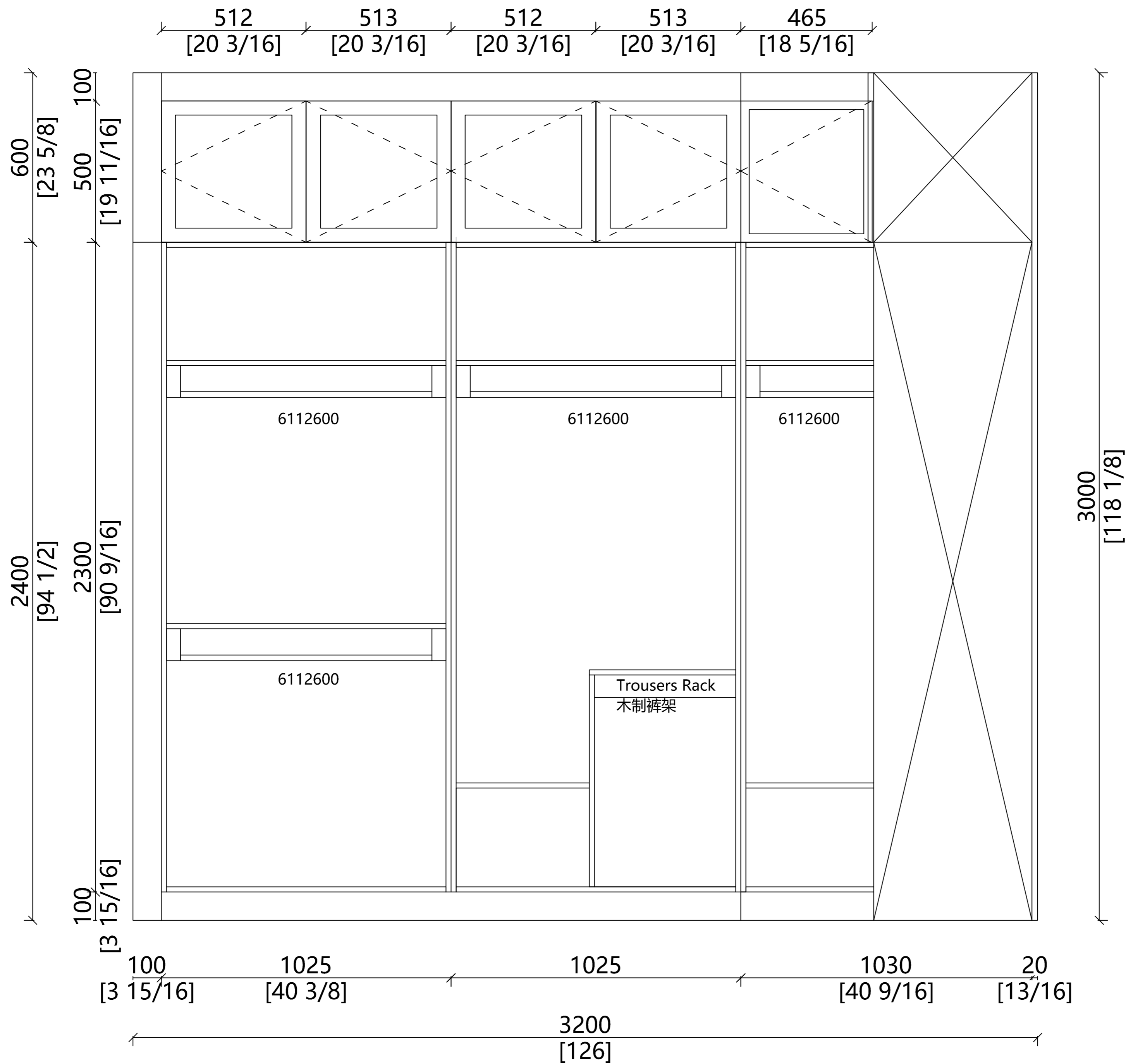

ELEVATION A

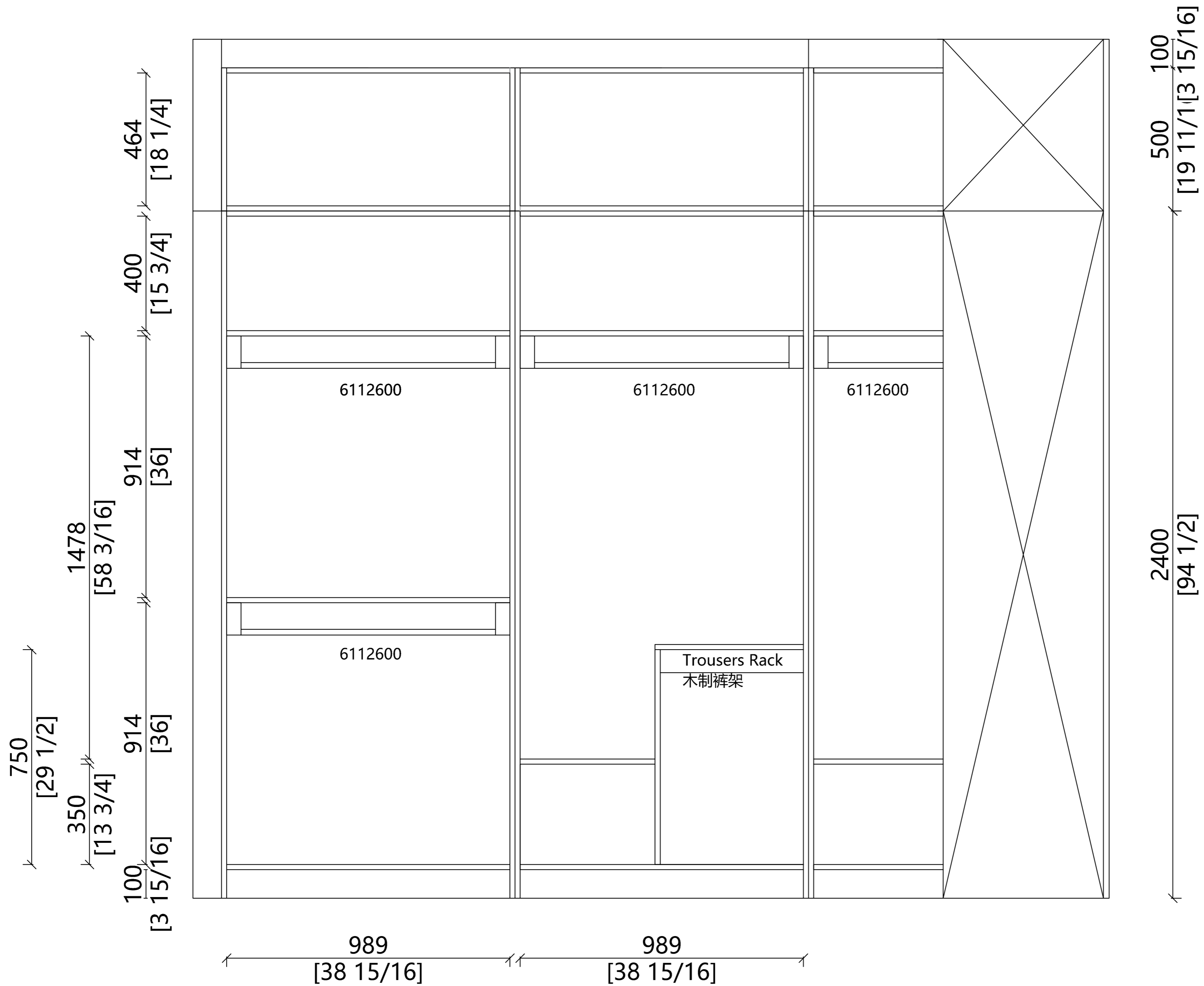

STRUCTURE A



Order No: LEIUS20231123001A	
Client Name: Shams	
Email:	
Client Address:	
Room Space: A closet	
Carcass Material	<input checked="" type="checkbox"/>
Door Material	<input type="checkbox"/>
Door Shape	<input checked="" type="checkbox"/>
Drawer Handle:	
Door Handle:	
Remark:	
Design Date:	
Lead Time: 10-12 Weeks	
Consignee:	
Date:	
Designer:	
Tel:	
Pages	

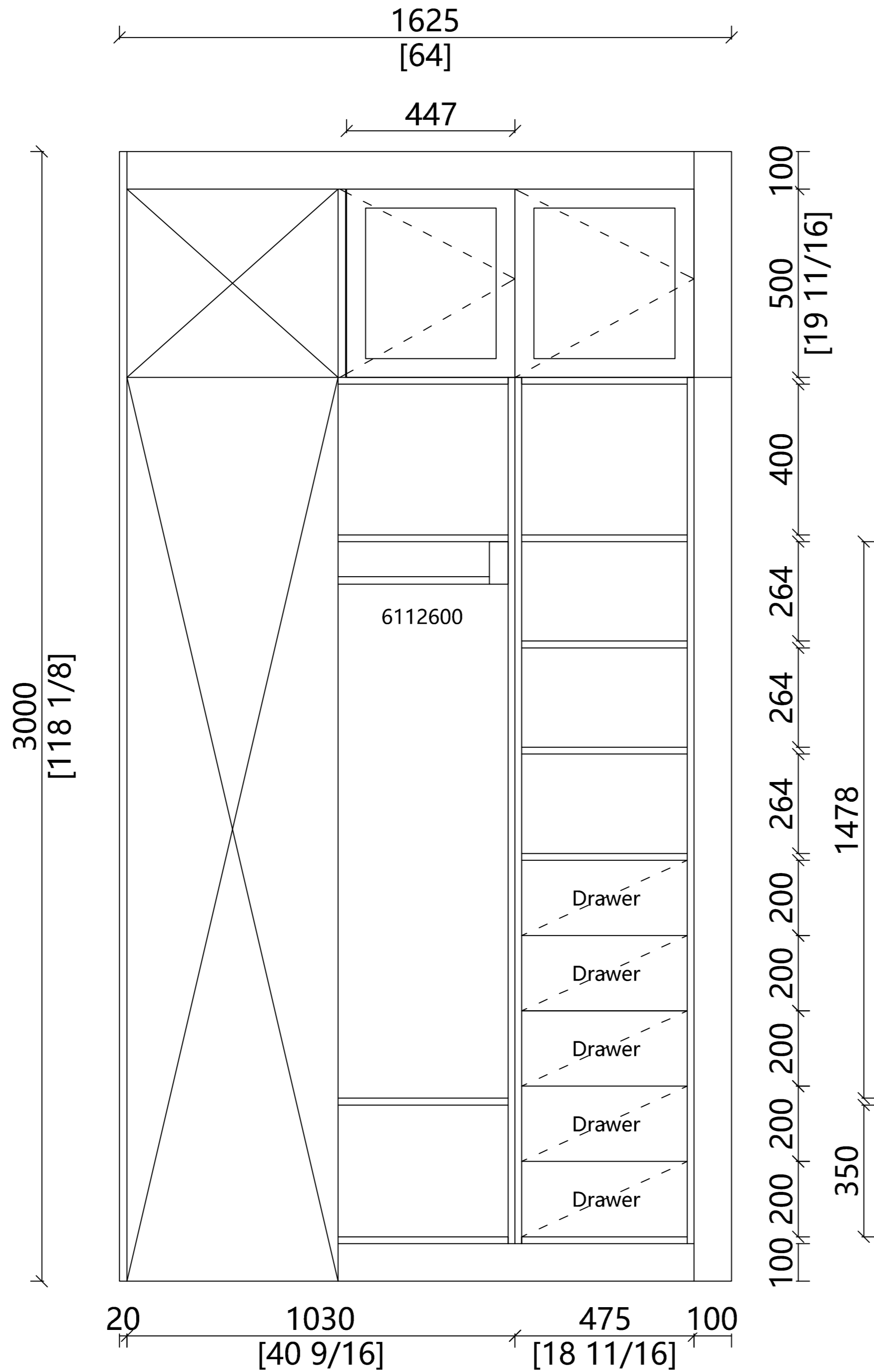

ELEVATION B



Order No: LEIUS20231123001A

Client Name: Shams

Email:

Client Address:

Room Space: A closet

Carcass	
Material	■
Door	□
Material	■
Door	⊗
Shape	□

Drawer Handle:

Door Handle:

Remark:

Design Date:

Lead Time: 10-12 Weeks

Consignee:
Date:

Designer:
Tel:

Pages

Z Closet



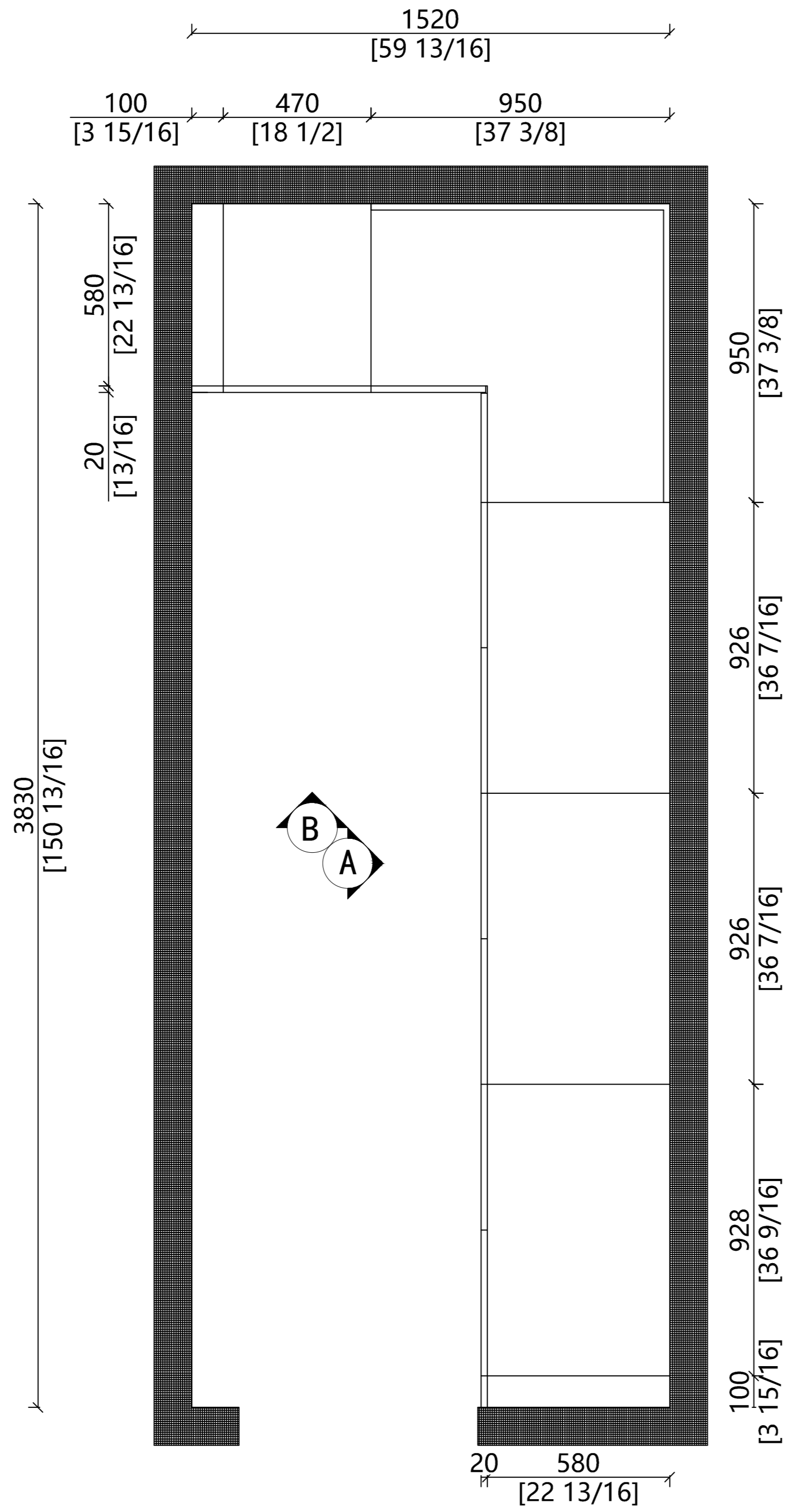

Plan

WAYMOVE

Order No: LEIUS20231123001A

Client Name: Shams

Email:

Client Address:

Room Space: Z closet

Carcass	
Material	<input checked="" type="checkbox"/>
Door	<input type="checkbox"/>
Material	<input checked="" type="checkbox"/>
Door	<input checked="" type="checkbox"/>
Shape	<input type="checkbox"/>

Drawer Handle:

Door Handle:

Remark:

Design Date:

Lead Time: 10-12 Weeks

Consignee:

Date:

Designer:

Tel:

Pages

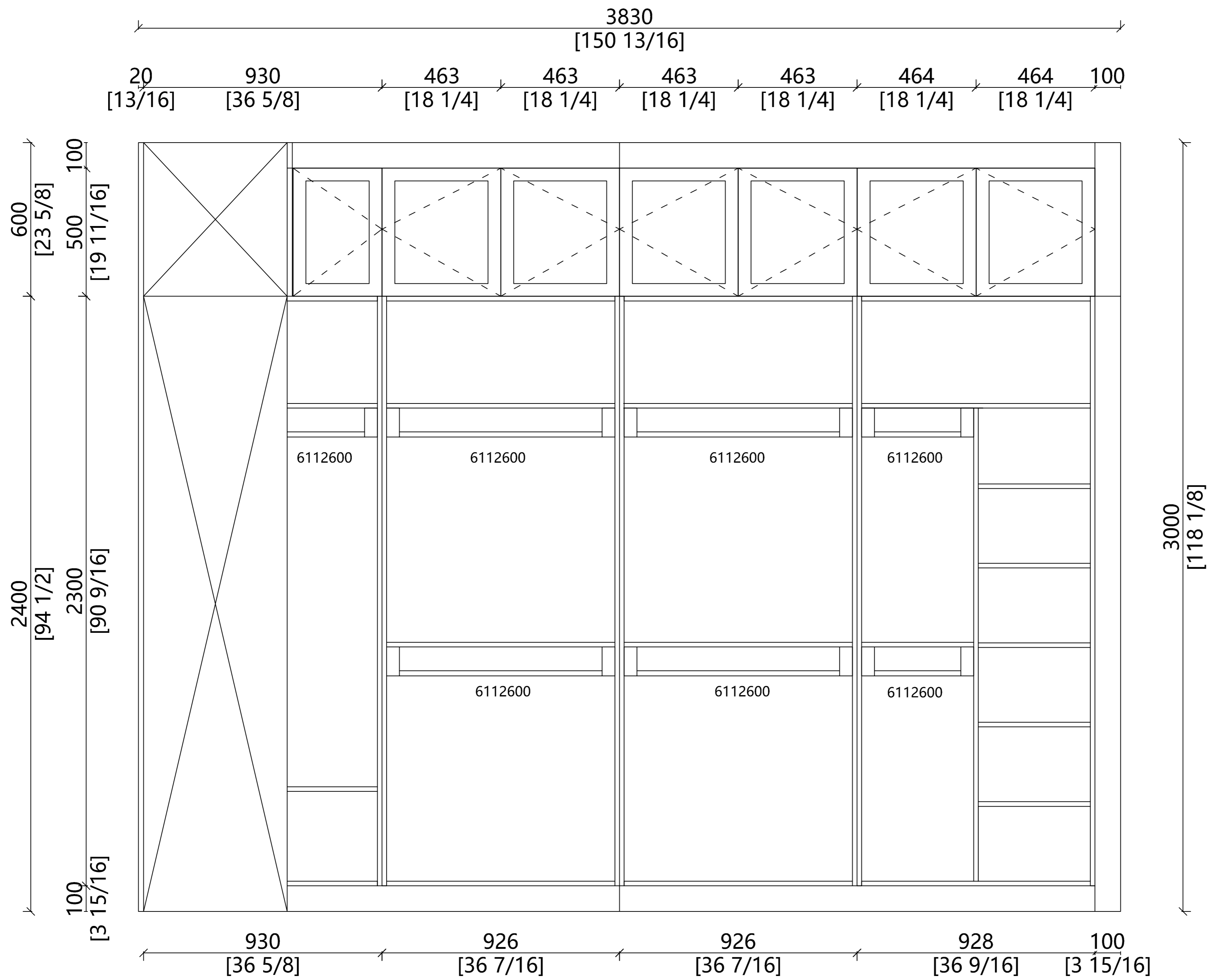

ELEVATION A



Order No: LEIUS20231123001A

Client Name: Shams

Email:

Client Address:

Room Space: Z closet

Carcass	
Material	
Door	<input type="checkbox"/>
Material	
Door	
Shape	<input type="checkbox"/>

Drawer Handle:

Door Handle:

Remark:

Design Date:

Lead Time: 10-12 Weeks

Consignee:

Date:

Designer:

Tel:

Pages

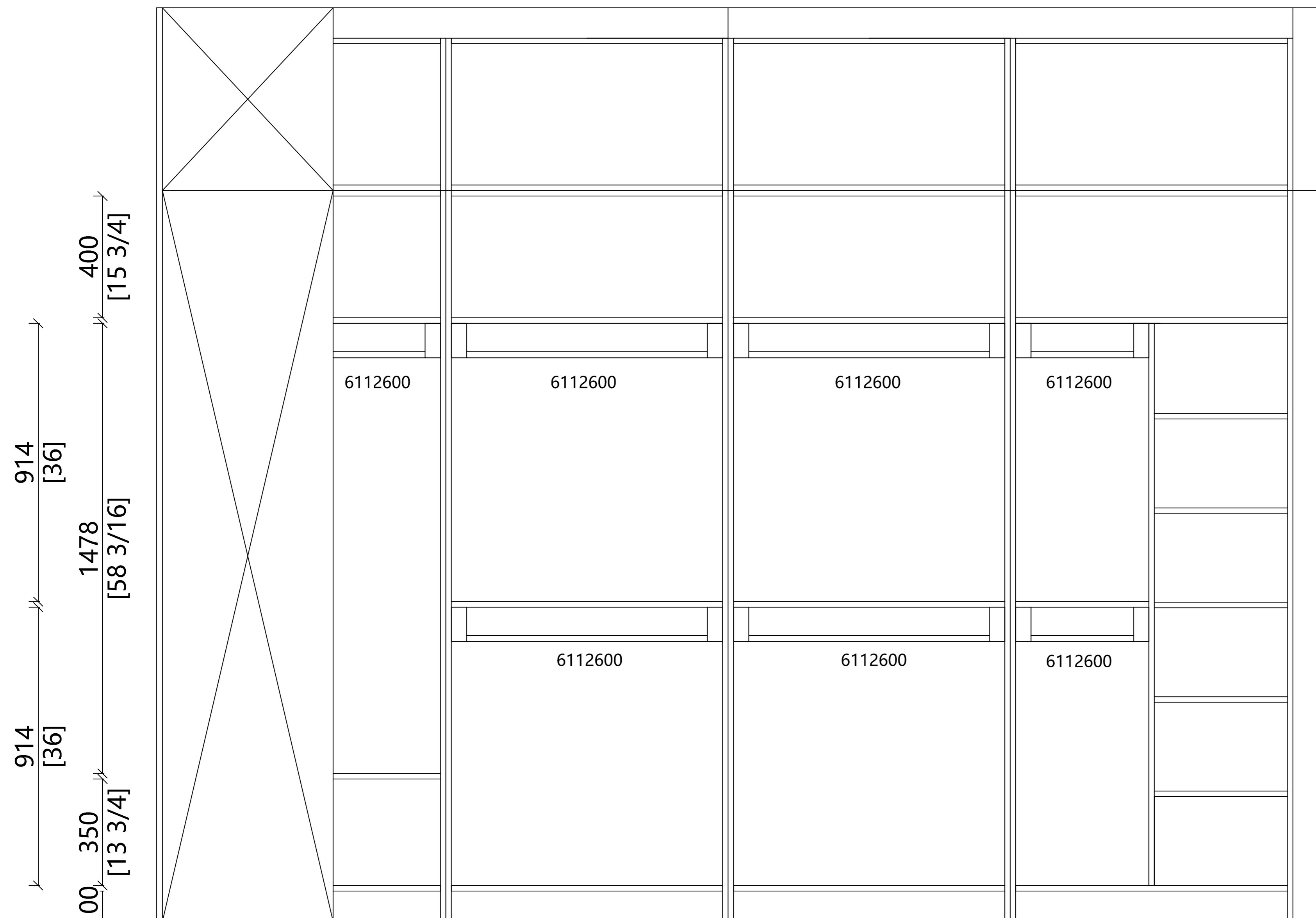

914 [36]
 914 [36]
 1478 [58 3/16]
 400 [15 3/4]
 100 [13 3/4]

464 [18 1/4]
 400 [15 3/4]
 296
 292
 292
 292
 292
 292
 292 [11 1/2]

890 [35 1/16]
 890 [35 1/16]
 892 [35 1/8]
 437 [17 3/16]
 437 [17 3/16]

STRUCTURE A



Order No: LEIUS20231123001A	
Client Name: Shams	
Email:	
Client Address:	
Room Space: Z closet	
Carcass Material	<input checked="" type="checkbox"/>
Door Material	<input type="checkbox"/>
Door Shape	<input checked="" type="checkbox"/>
Drawer Handle:	
Door Handle:	
Remark:	
Design Date:	
Lead Time: 10-12 Weeks	
Consignee:	
Date:	
Designer:	
Tel:	
Pages	

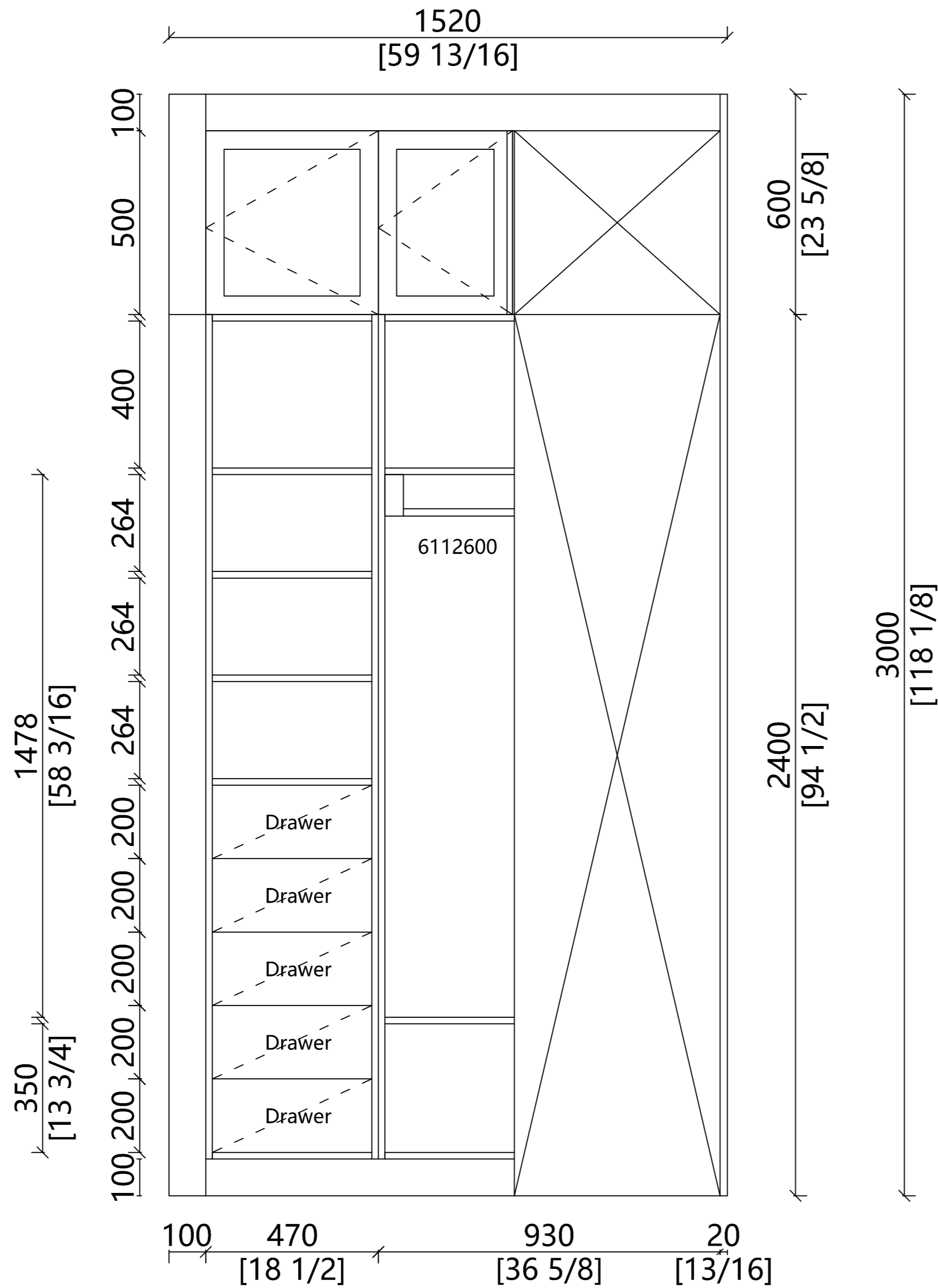

ELEVATION B

WAYMOVE

Order No: LEIUS20231123001A

Client Name: Shams

Email:

Client Address:

Room Space: Z closet

Carcass

Material



Door

Material



Door

Shape



Drawer Handle:

Door Handle:

Remark:

Design Date:

Lead Time: 10-12 Weeks

Consignee:

Date:

Designer:

Tel:

Pages

S Closet



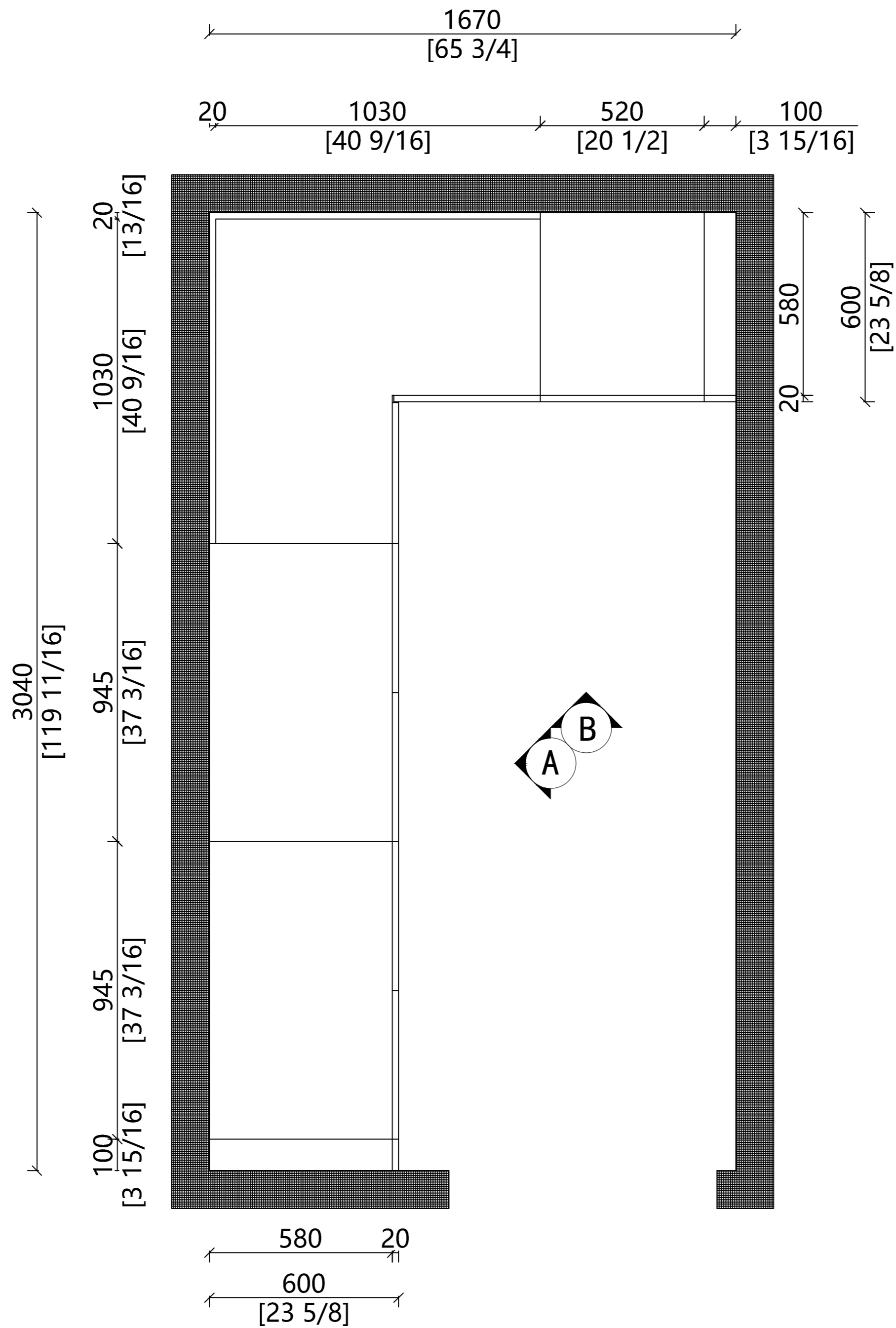

Plan



Order No: LEIUS20231123001A

Client Name: Shams

Email:

Client Address:

Room Space: S closet

Carcass	
Material	
Door	<input type="checkbox"/>
Material	
Door	<input checked="" type="checkbox"/>
Shape	<input type="checkbox"/>

Drawer Handle:

Door Handle:

Remark:

Design Date:

Lead Time: 10-12 Weeks

Consignee:
Date:

Designer:
Tel:

Pages

WAYMOVE



Order No: LEIUS20231123001A

Client Name: Shams

Email:

Client Address:

Room Space: S closet

Carcass	
Material	
Door	<input type="checkbox"/>
Material	
Door	
Shape	<input type="checkbox"/>

Drawer Handle:

Door Handle:

Remark:

Design Date:

Lead Time: 10-12 Weeks

Consignee:

Date:

Designer:

Tel:

Pages

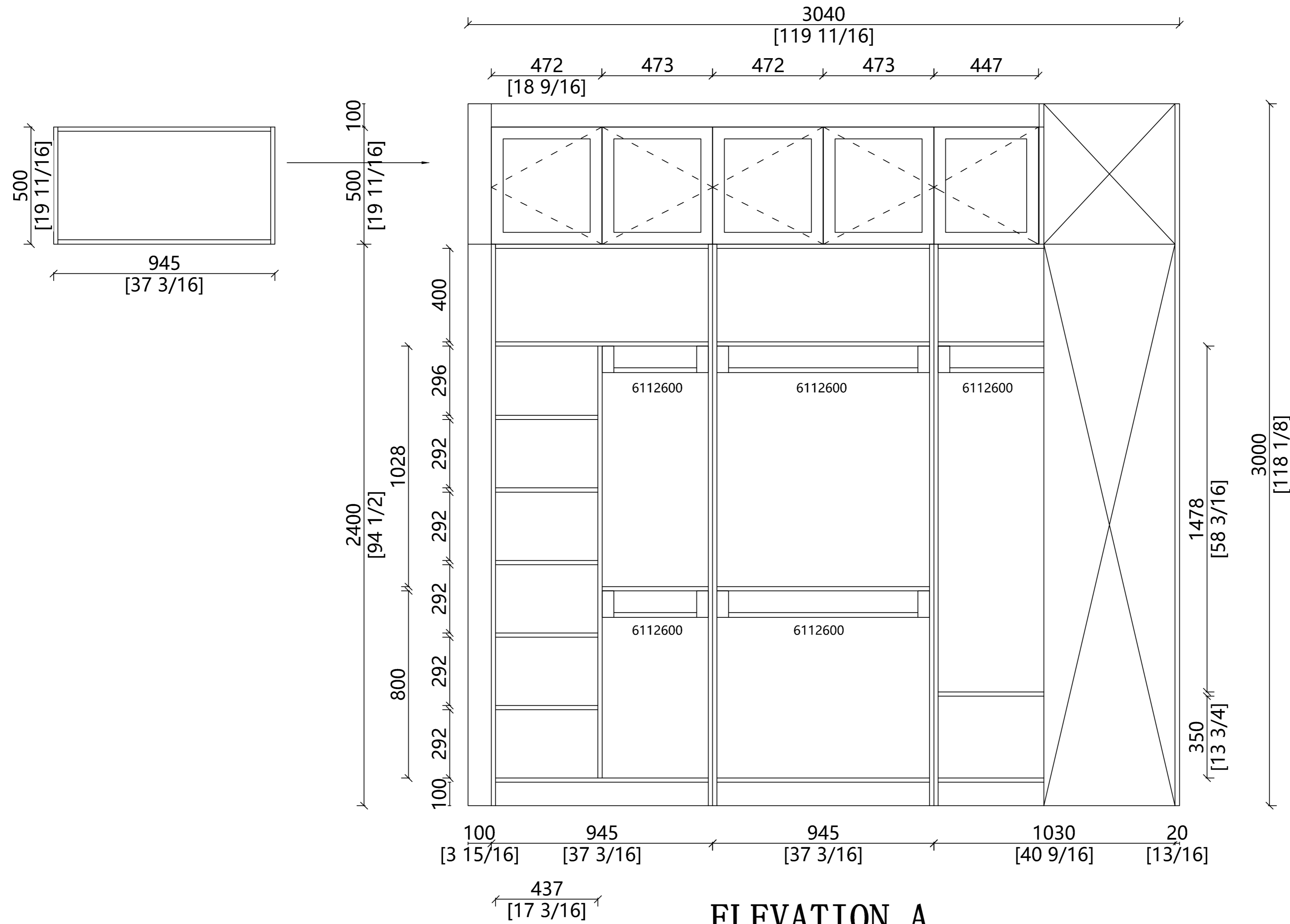

ELEVATION A

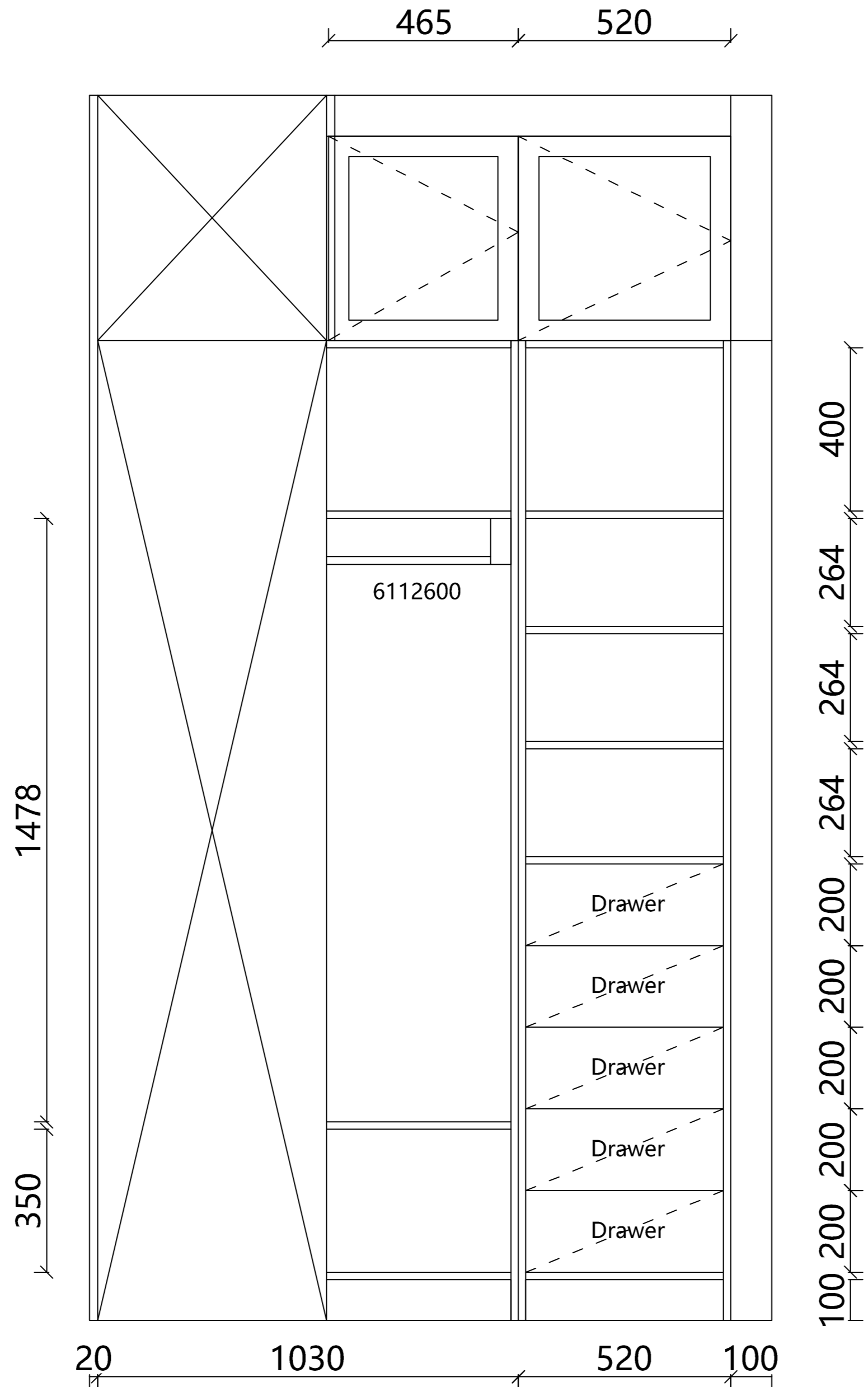

ELEVATION B



Order No: LEIUS20231123001A

Client Name: Shams

Email:

Client Address:

Room Space: S closet

Carcass	
Material	
Door	<input type="checkbox"/>
Material	
Door	
Shape	<input type="checkbox"/>

Drawer Handle:

Door Handle:

Remark:

Design Date:

Lead Time: 10-12 Weeks

Consignee:

Date:

Designer:

Tel:

Pages

K Closet 1



WAYMOVE



Order No: LEIUS20231123001A

Client Name: Shams

Email:

Client Address:

Room Space: K closet-1

Carcass	
Material	
Door	<input type="checkbox"/>
Material	
Door	
Shape	<input type="checkbox"/>

Drawer Handle:

Door Handle:

Remark:

Design Date:

Lead Time: 10-12 Weeks

Consignee:

Date:

Designer:

Tel:

Pages

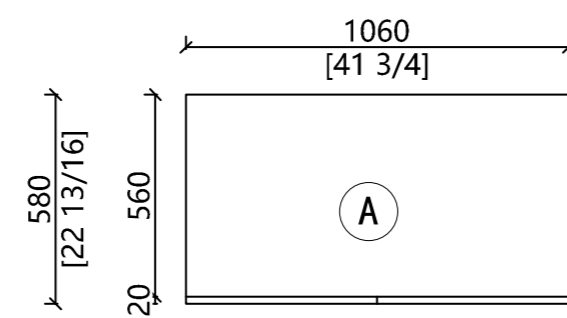
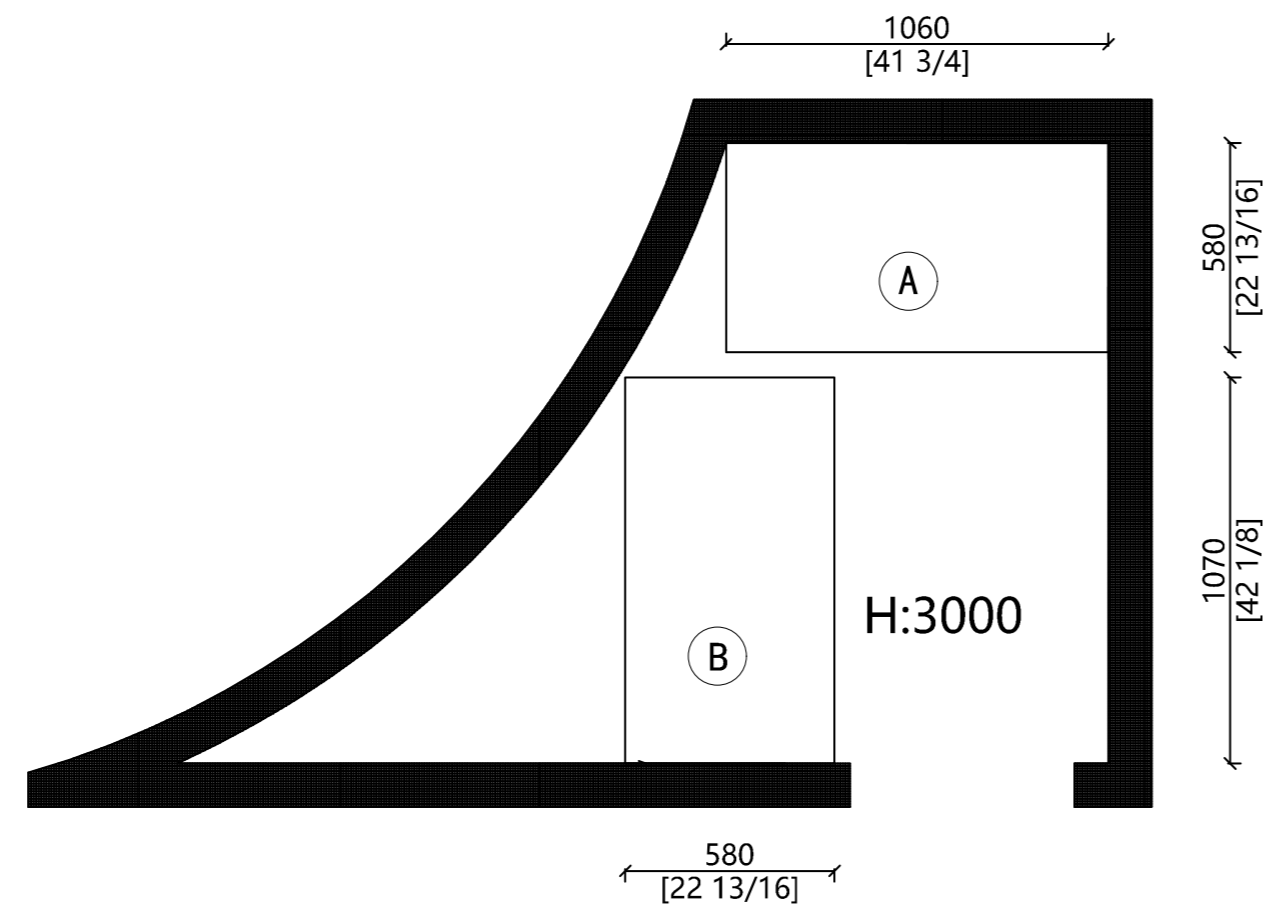

Plan A

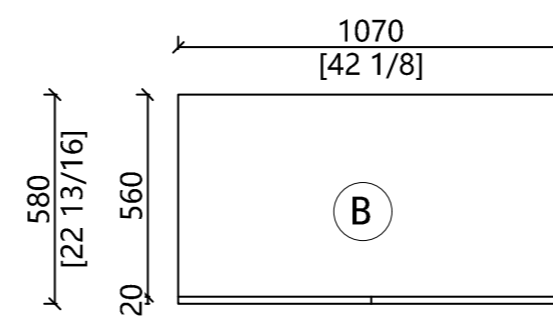

Plan B

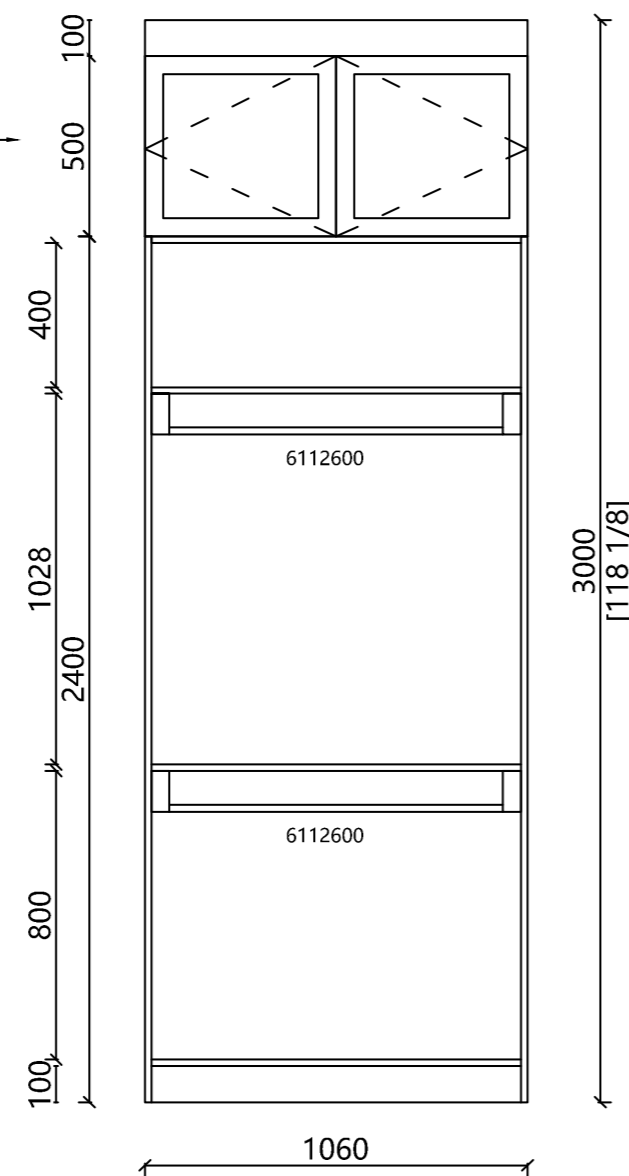
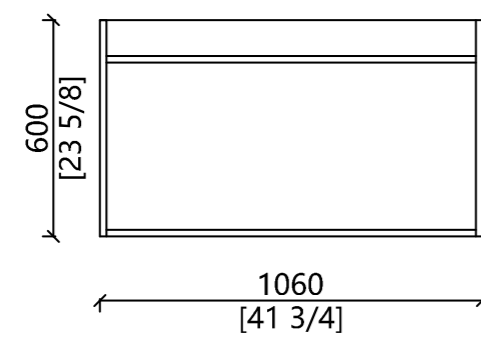

ELEVATION A

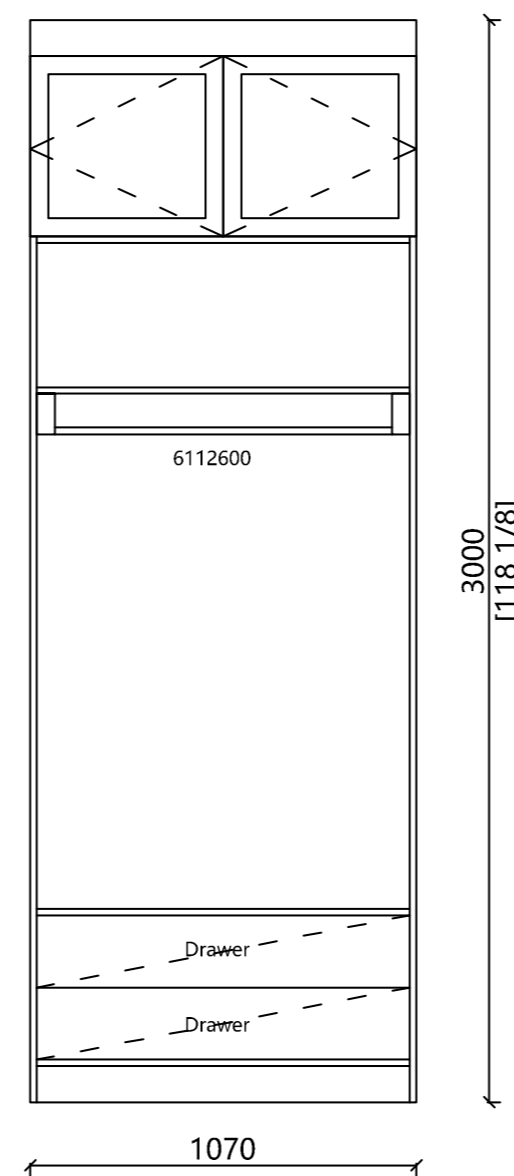

ELEVATION B

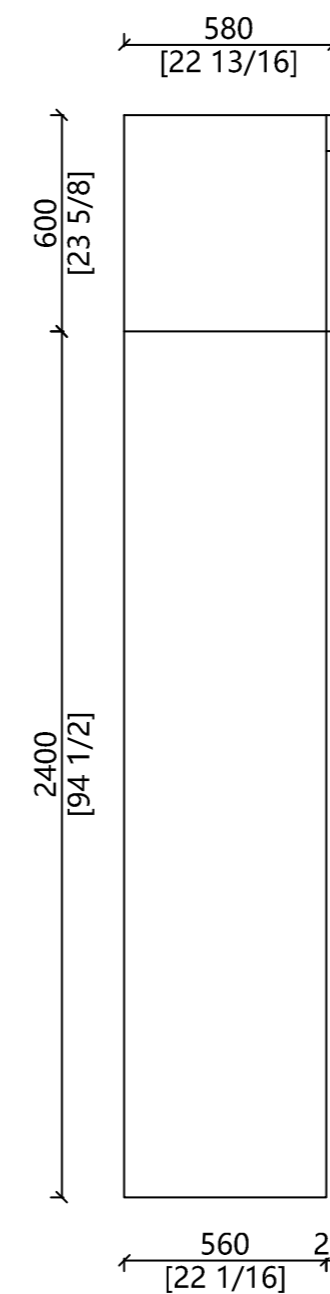

K Closet 2



WAYMOVE

Order No: LEIUS20231123001A

Client Name: Shams

Email:

Client Address:

Room Space: K closet-2

Carcass Material	<input checked="" type="checkbox"/>
Door Material	<input type="checkbox"/>
Door Shape	<input checked="" type="checkbox"/>

Drawer Handle:

Door Handle:

Remark:

Design Date:

Lead Time: 10-12 Weeks

Consignee:

Date:

Designer:

Tel:

Pages

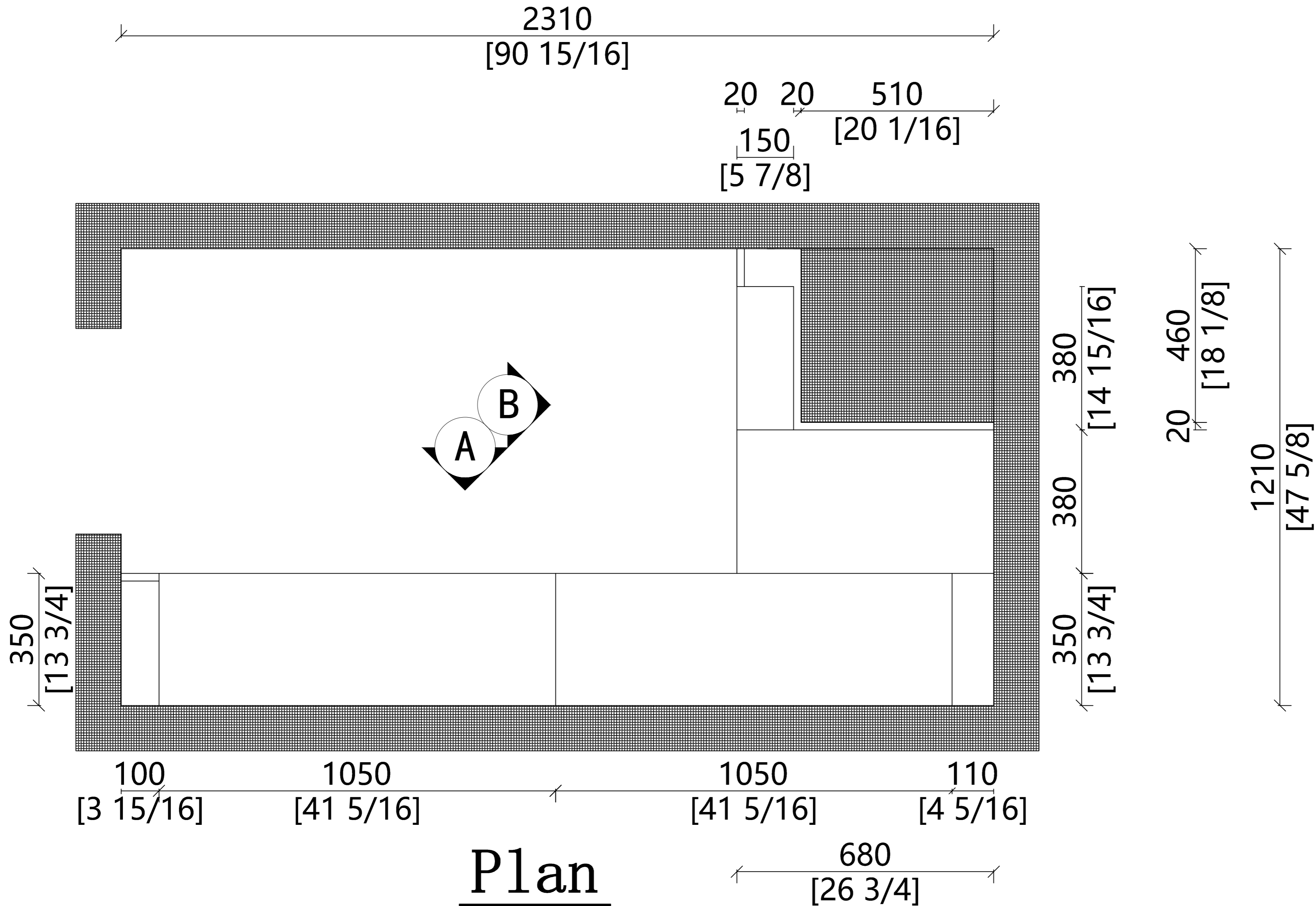

Plan

WAYMOVE

Order No: LEIUS20231123001A

Client Name: Shams

Email:

Client Address:

Room Space: K closet-2

Carcass	
Material	<input checked="" type="checkbox"/>
Door	<input type="checkbox"/>
Material	<input checked="" type="checkbox"/>
Door	<input checked="" type="checkbox"/>
Shape	<input type="checkbox"/>

Drawer Handle:

Door Handle:

Remark:

Design Date:

Lead Time: 10-12 Weeks

Consignee:

Date:

Designer:

Tel:

Pages

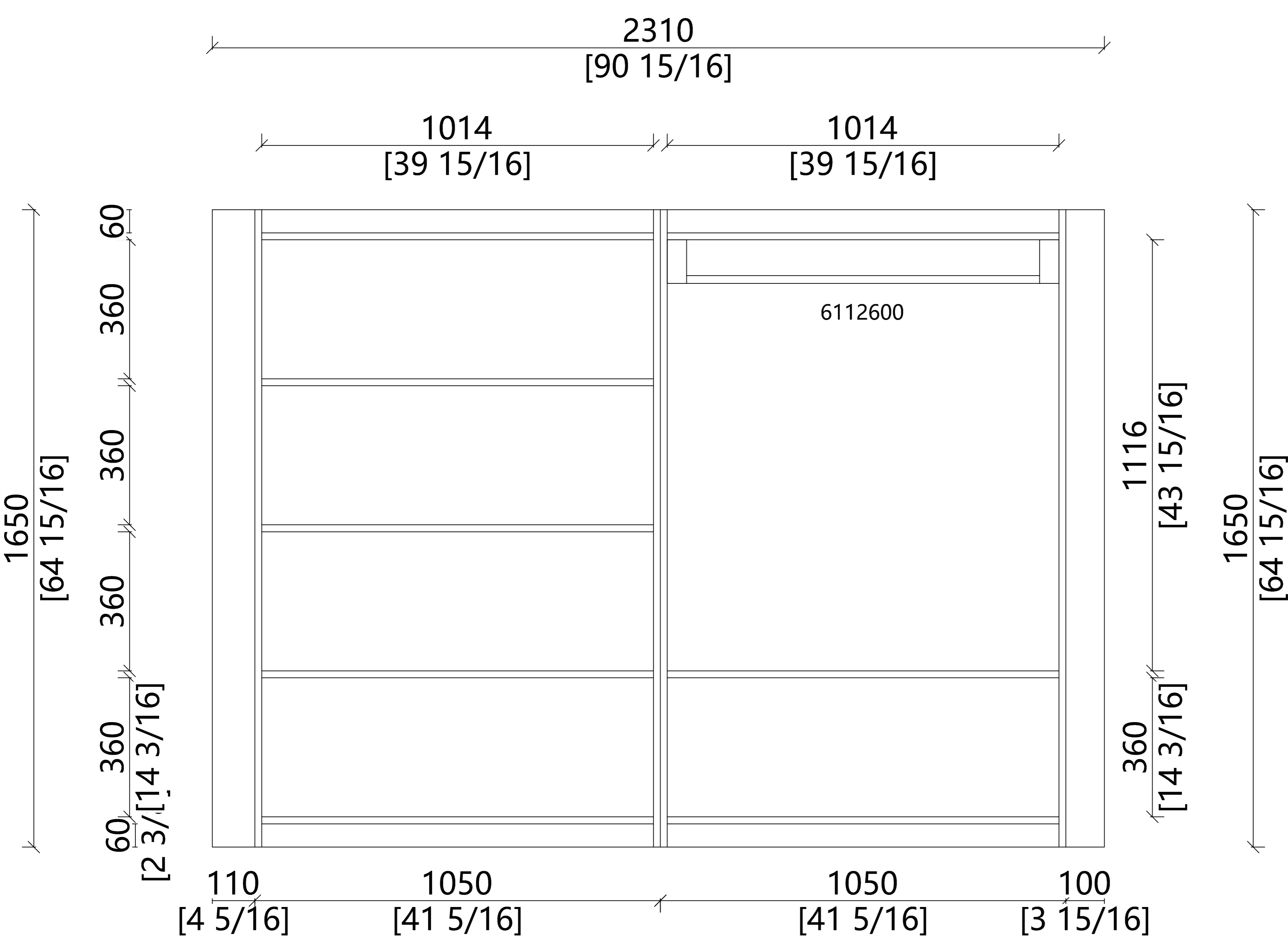

ELEVATION A

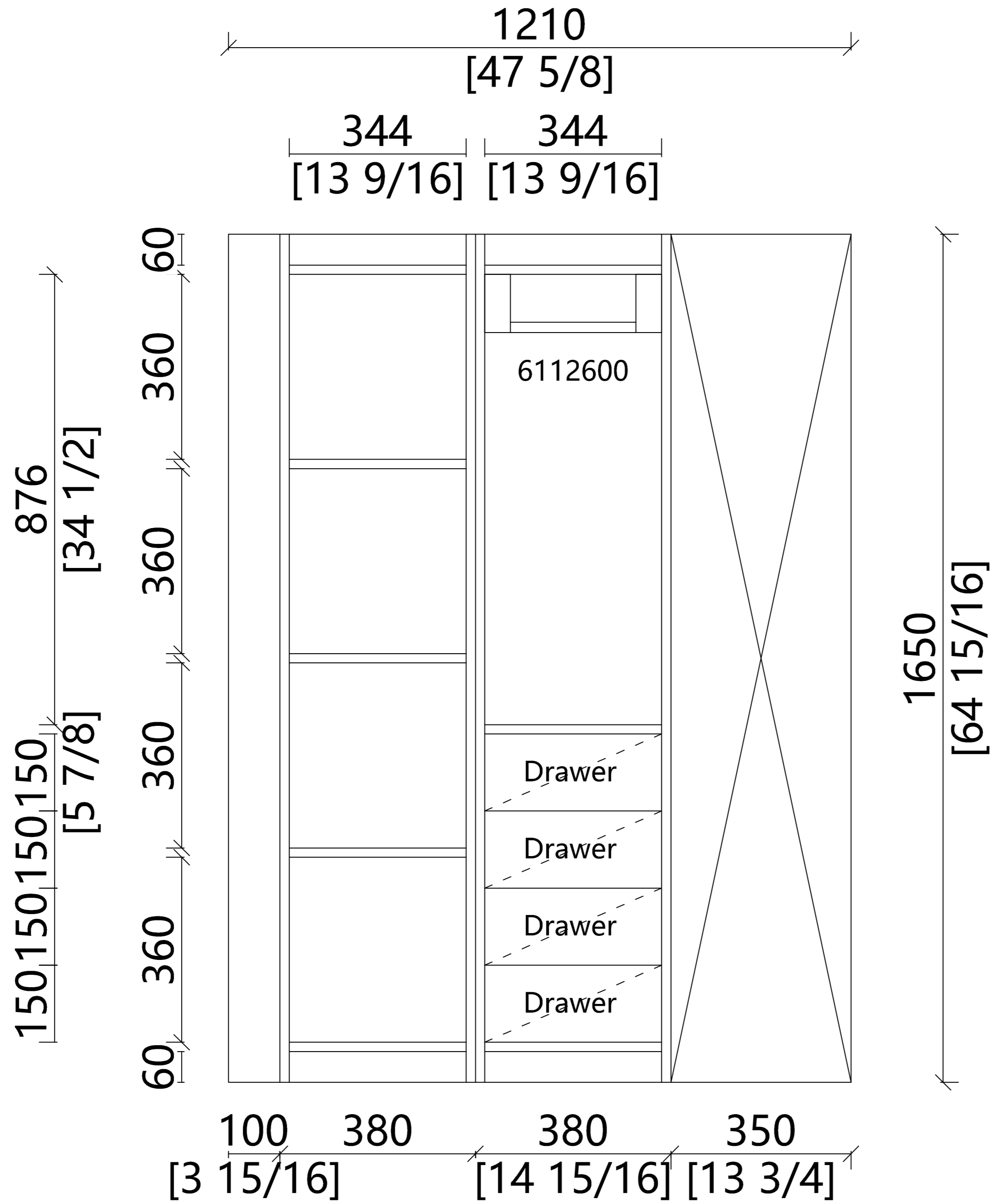

ELEVATION B



Order No: LEIUS20231123001A

Client Name: Shams

Email:

Client Address:

Room Space: K closet-2

Carcass Material	<input checked="" type="checkbox"/>
Door Material	<input type="checkbox"/>
Door Shape	<input checked="" type="checkbox"/>

Drawer Handle:

Door Handle:

Remark:

Design Date:

Lead Time: 10-12 Weeks

Consignee:
Date:

Designer:
Tel:

Pages

O Closet 1



WAYMOVE

Order No: LEIUS20231123001A

Client Name: Shams

Email:

Client Address:

Room Space: O closet-1

Carcass Material	<input checked="" type="checkbox"/>
Door Material	<input checked="" type="checkbox"/>
Door Shape	<input checked="" type="checkbox"/>
	<input type="checkbox"/>

Drawer Handle:

Door Handle:

Remark:

Design Date:

Lead Time: 10-12 Weeks

Consignee:

Date:

Designer:

Tel:

Pages

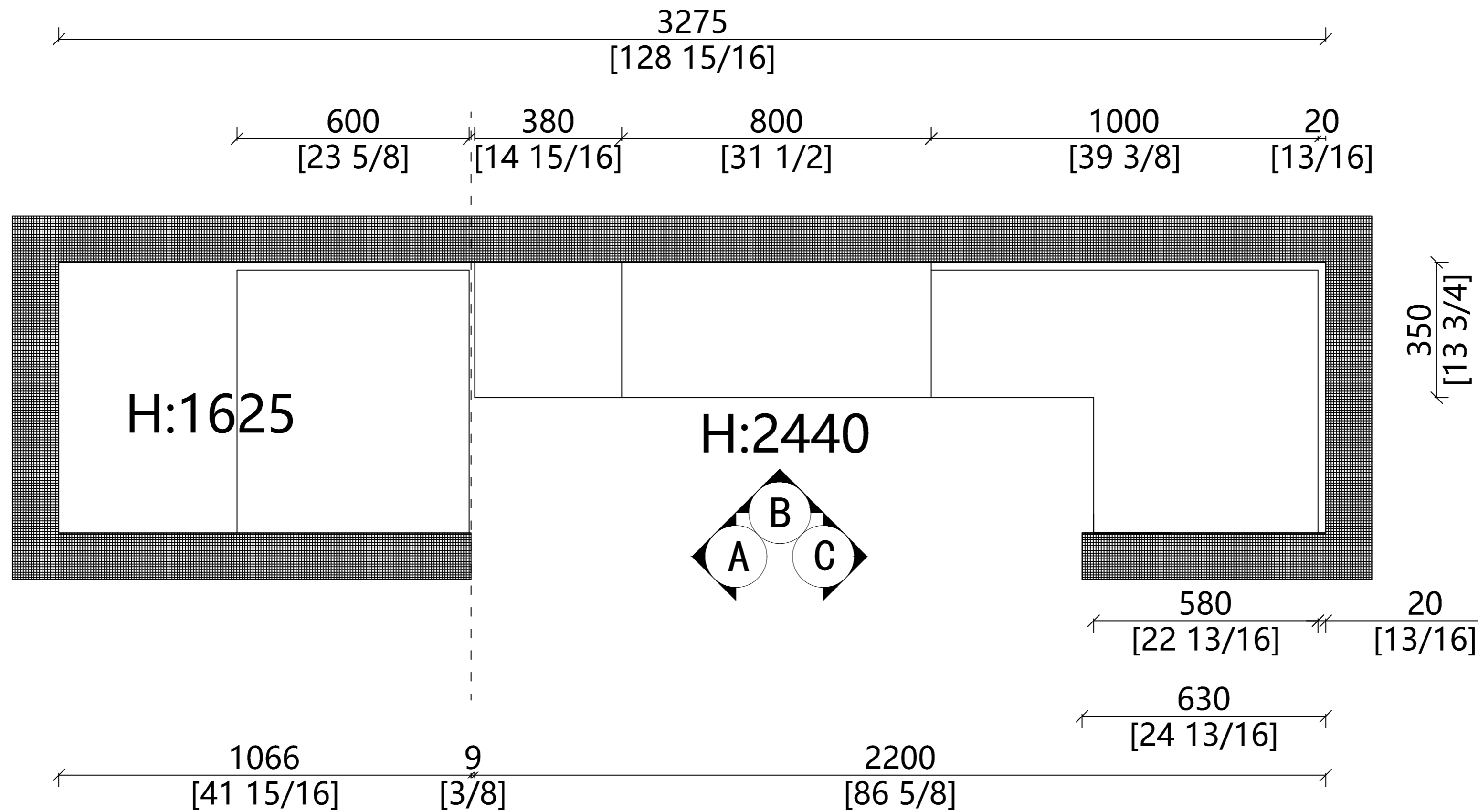

WAYMOVE



Order No: LEIUS20231123001A

Client Name: Shams

Email:

Client Address:

Room Space: O closet-1

Carcass Material	
Door Material	<input type="checkbox"/>
Door Shape	

Drawer Handle:

Door Handle:

Remark:

Design Date:

Lead Time: 10-12 Weeks

Consignee:

Date:

Designer:

Tel:

Pages

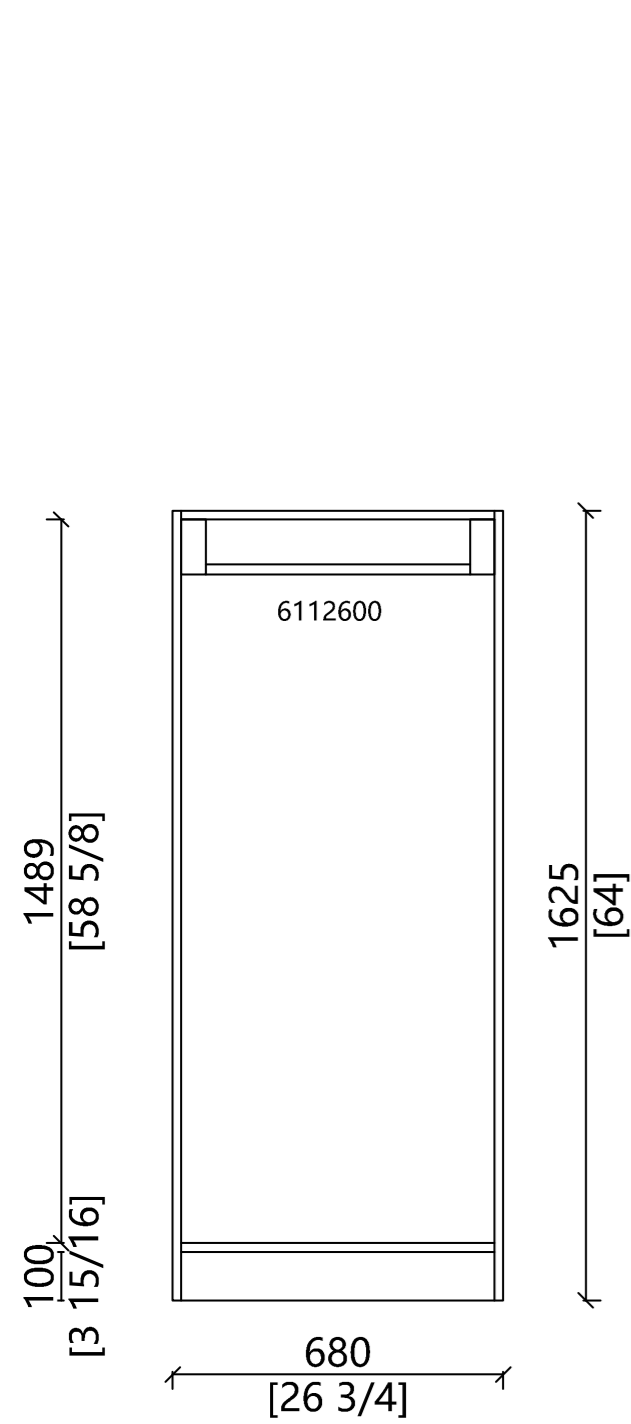

ELEVATION A

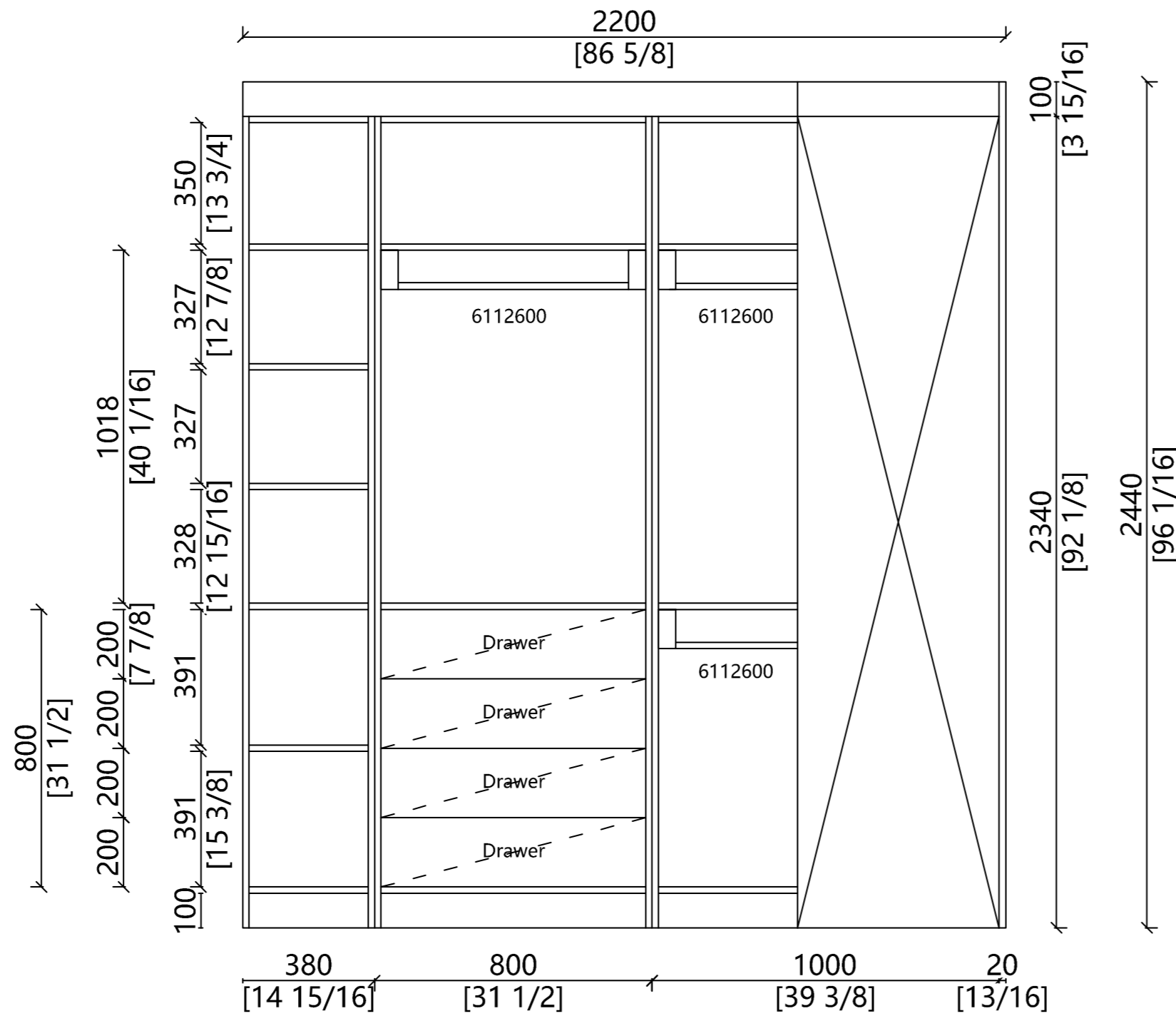

ELEVATION B

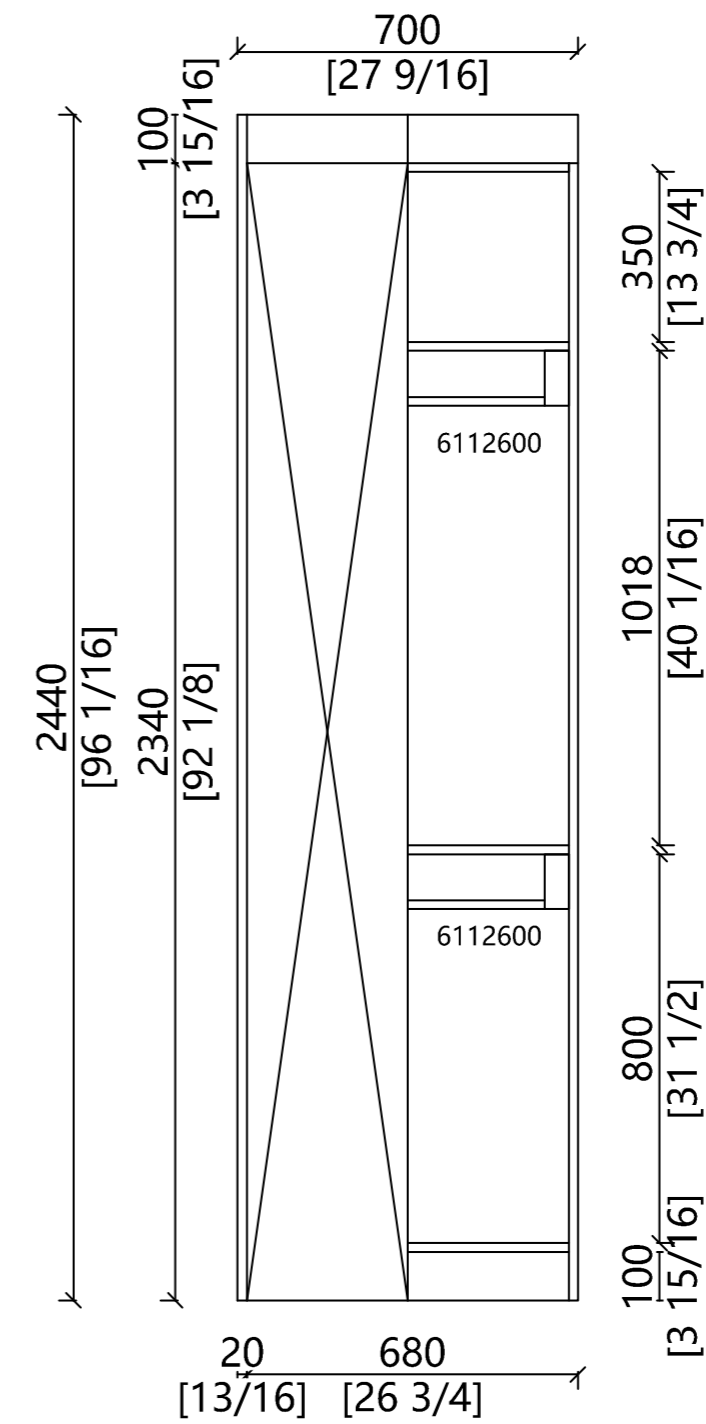

ELEVATION C

O Closet 2



WAYMOVE

Order No: LEIUS20231123001A

Client Name: Shams

Email:

Client Address:

Room Space: O closet-2

Carcass Material	<input checked="" type="checkbox"/>
Door Material	<input type="checkbox"/>
Door Shape	<input checked="" type="checkbox"/>

Drawer Handle:

Door Handle:

Remark:

Design Date:

Lead Time: 10-12 Weeks

Consignee:

Date:

Designer:

Tel:

Pages

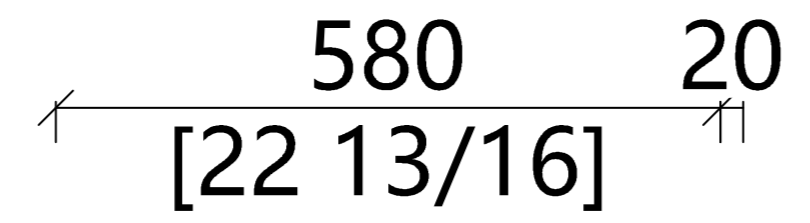
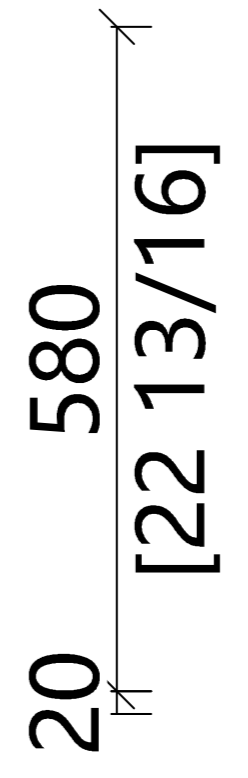
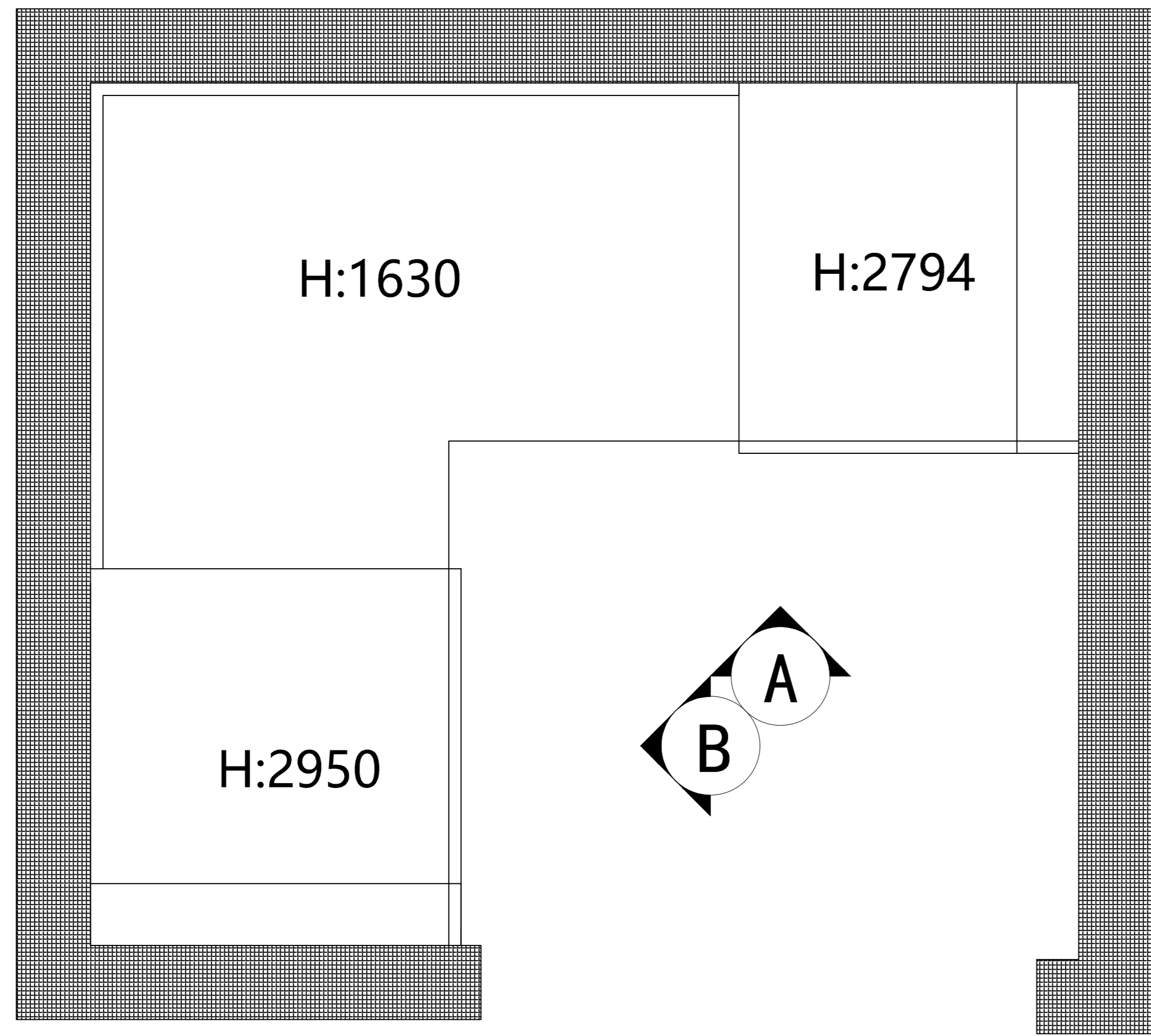
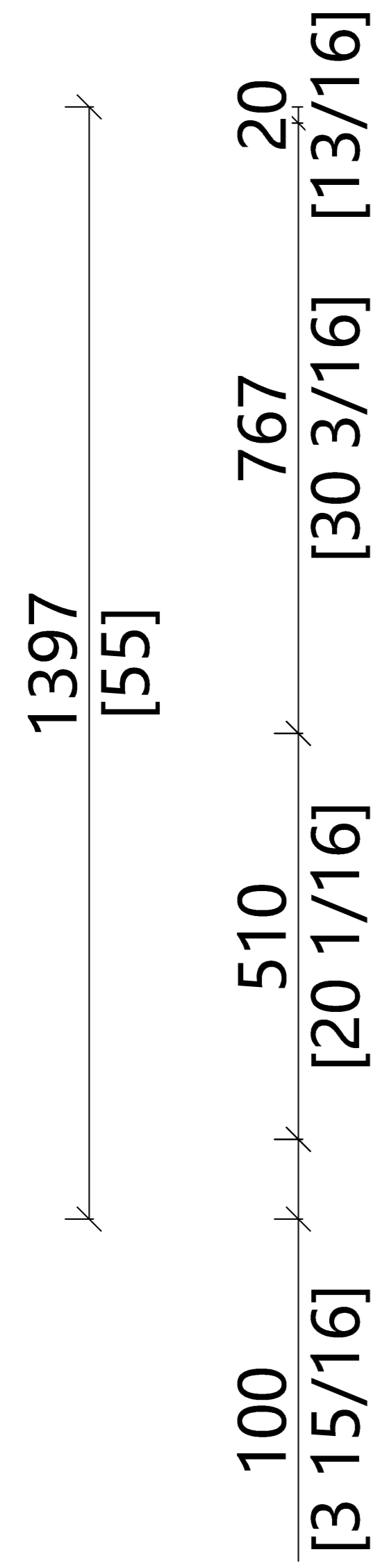
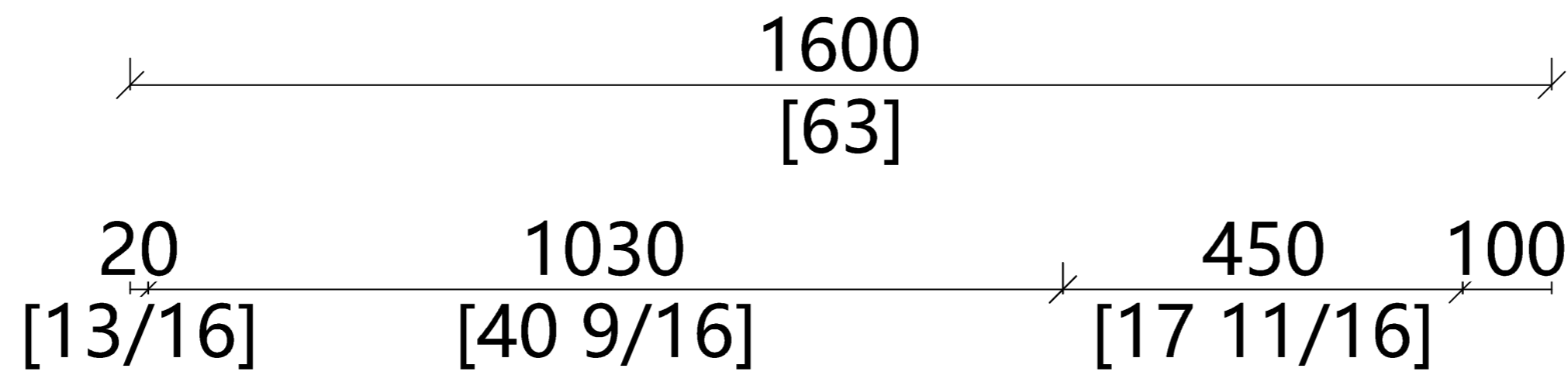

Plan

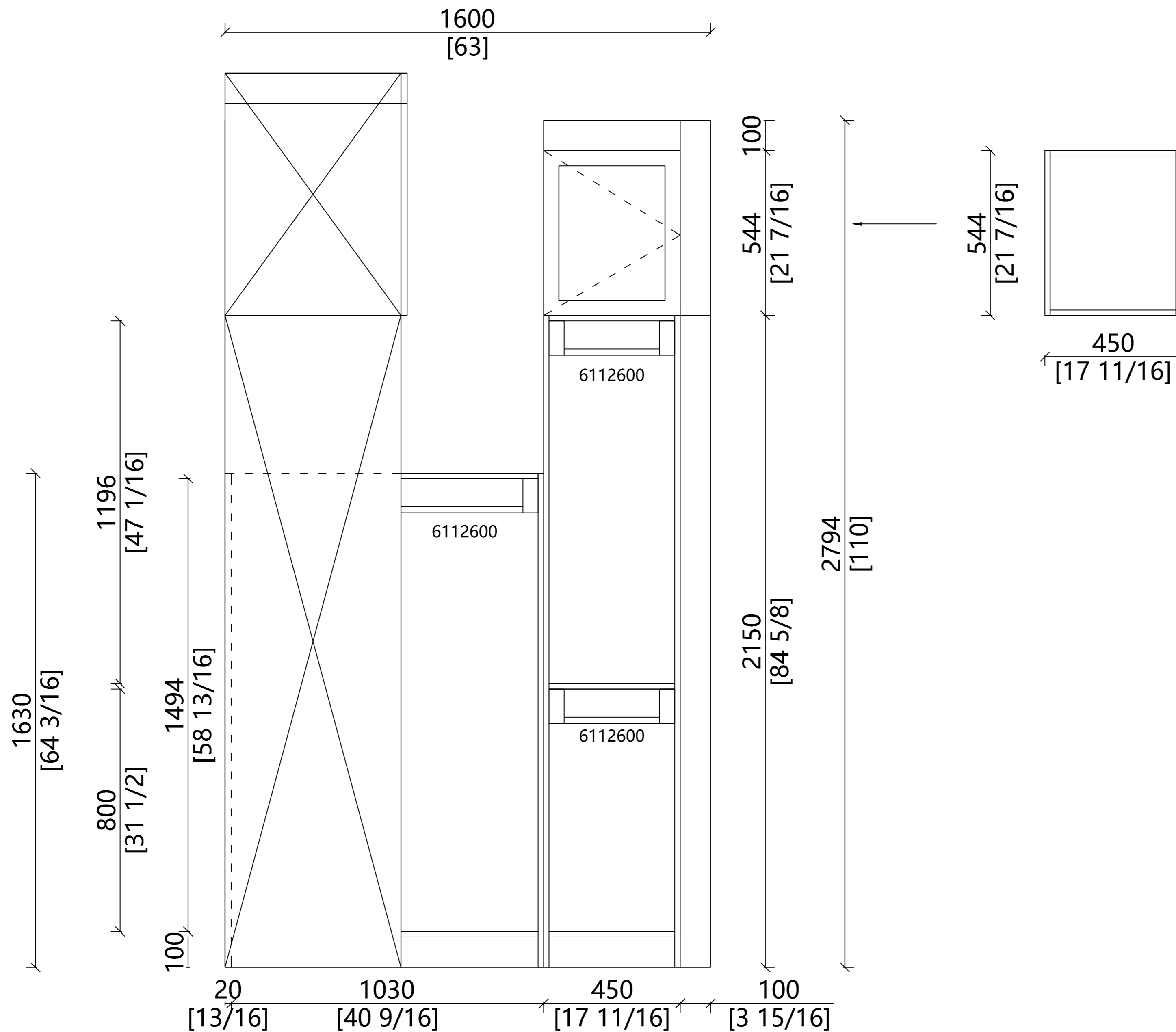

ELEVATION A



Order No: LEIUS20231123001A

Client Name: Shams

Email:

Client Address:

Room Space: O closet-2

Carcass	
Material	<input checked="" type="checkbox"/>
Door	<input type="checkbox"/>
Material	<input checked="" type="checkbox"/>
Door	<input checked="" type="checkbox"/>
Shape	<input type="checkbox"/>

Drawer Handle:

Door Handle:

Remark:

Design Date:

Lead Time: 10-12 Weeks

Consignee:

Date:

Designer:

Tel:

Pages

Vanity



Carcase

Finish: MelamineBA2007
Material: Plywood(E0)
Thickness: 18mm/9 mm

柜体/多层板BA2007



Handleless

Aluminum alloy/matte black

黑色免拉手

Vanity



WAYMOVE

Order No: LEIUS20231123001A

Client Name: Shams

Email:

Client Address:

Room Space: Vanity

Carcass Material	<input checked="" type="checkbox"/>
Door Material	<input type="checkbox"/>
Door Shape	<input checked="" type="checkbox"/>

Drawer Handle:

Door Handle:

Remark:

Design Date:

Lead Time: 10-12 Weeks

Consignee:

Date:

Designer:

Tel:

Pages

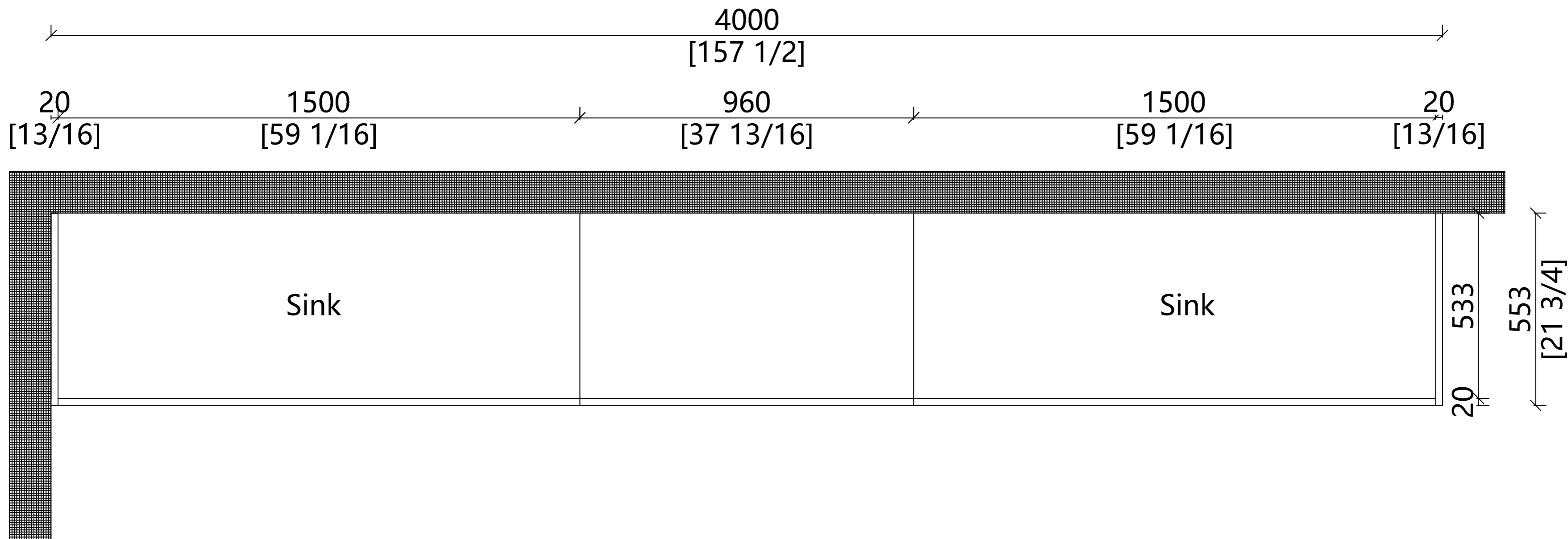

Plan

WAYMOVE



Order No: LEIUS20231123001A

Client Name: Shams

Email:

Client Address:

Room Space: Vanity

Carcass Material	
Door Material	
Door Shape	

Drawer Handle:

Door Handle:

Remark:

Design Date:

Lead Time: 10-12 Weeks

Consignee:

Date:

Designer:

Tel:

Pages

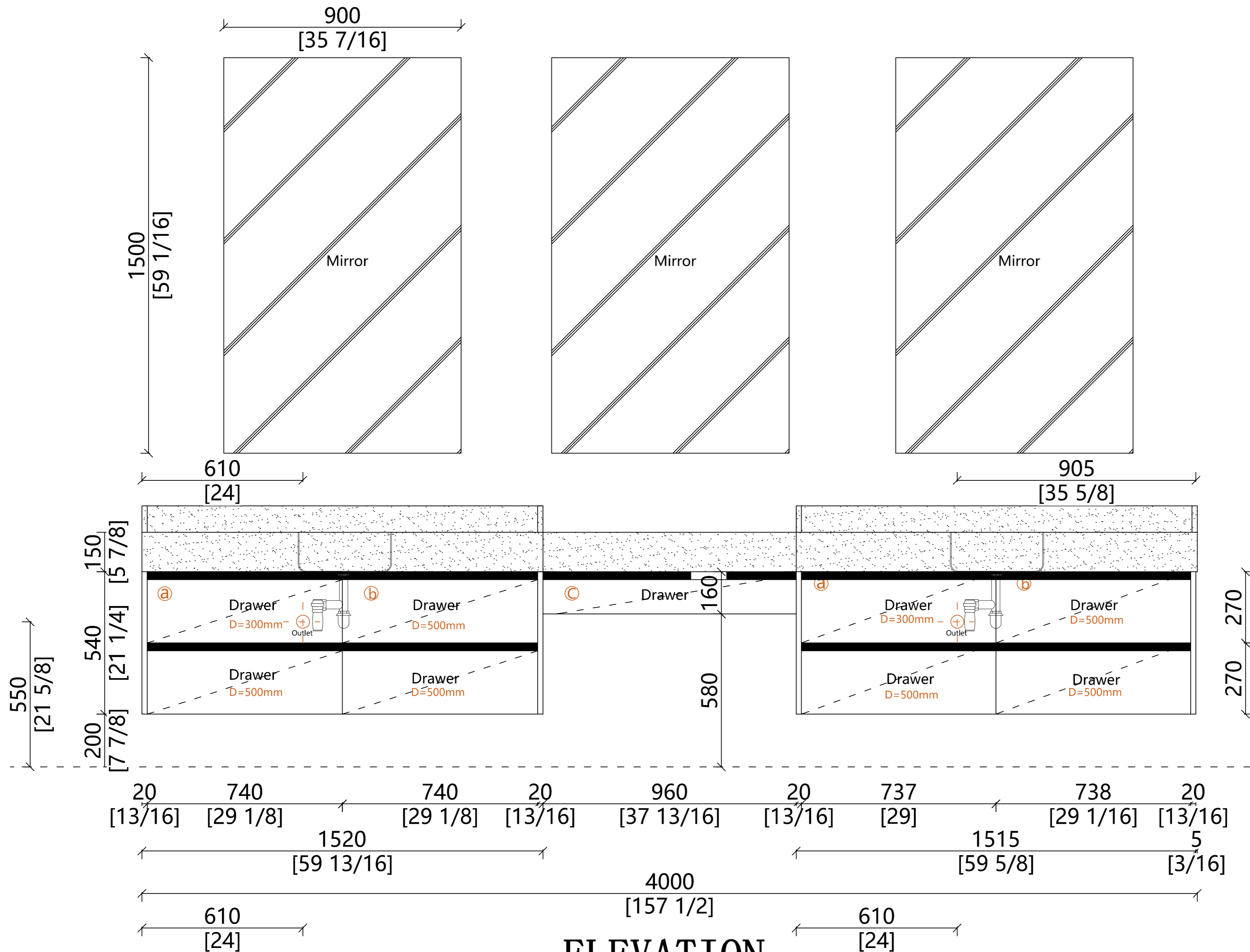

ELEVATION

WAYMOVE

Order No: LEIUS20231123001A

Client Name: Shams

Email:

Client Address:
U.S.A

Room Space: Vanity

Carcass Material	<input checked="" type="checkbox"/>
Door Material	<input type="checkbox"/>
Door Shape	<input checked="" type="checkbox"/>

Drawer Handle:

Door Handle:

Remark:

Design Date: 2/20/24

Lead Time: 10-12 Weeks

Consignee:

Date:

Designer:

Tel:

Pages

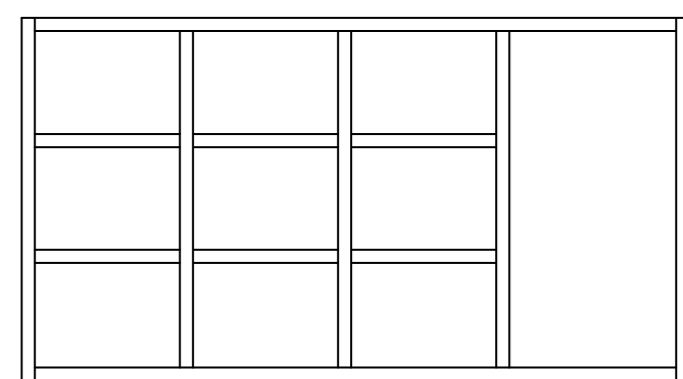
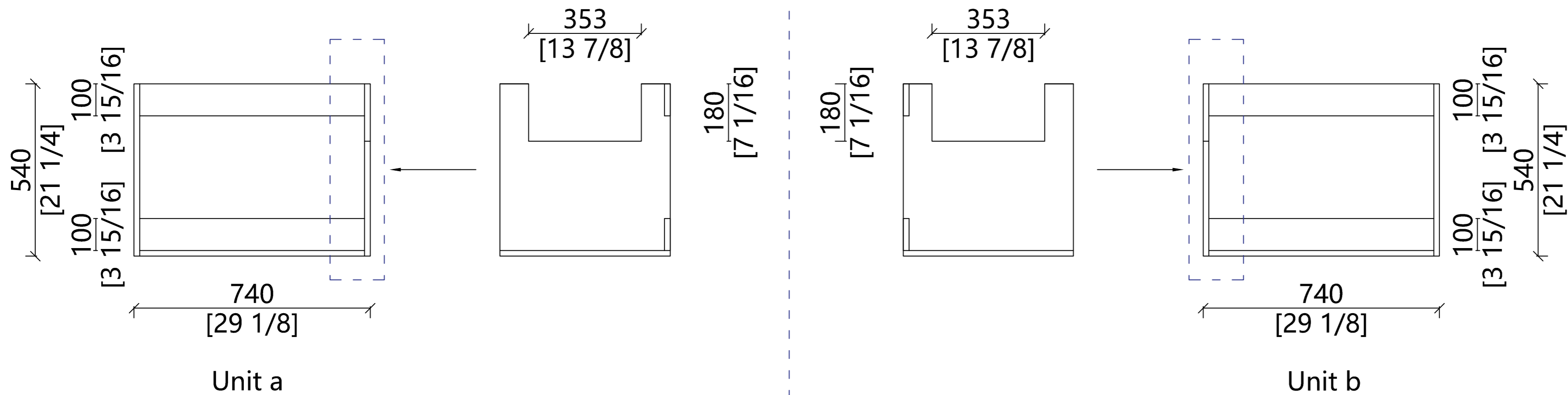

Unit c