

	Door1/End panel: Finish: Veneer DY1039 Material: HDF Thickness: 18 mm	门1/见光板: 表面处理: 贴皮 DY1039 基材: 密度板 厚度: 18mm 绿线标注
	Door2/End panel: Finish: Painted DY1012 Material: HDF Thickness: 18 mm	门2/见光板: 表面处理: 油漆 DY1012 基材: 密度板 厚度: 18mm
	Coutertop: Finish: CALAEATTA Material: Sintered Stone Thickness: 12mm	台面: 颜色: 圣勃朗鱼肚白 基材: 岩板 厚度: 12mm
	H1: Handleless/Black/ Aluminum alloy	
	H2: Long Handle/ M524 Length: 1100mm Color: Black	
	H3: Short Handle/ M552 Length: 210mm Color: Black	
	H4: Short Handle/ M540 Length: 200mm Color: Black	

	Carcase: Finish: DY1039 Material: MFC(E0) Thickness: 18 mm	柜体: 颜色: DY1039 基材: 颗粒板 厚度: 18mm
	Carcase: Finish: DY1012 Material: MFC(E0) Thickness: 18 mm	柜体: 颜色: DY1012 基材: 颗粒板 厚度: 18mm
	Coutertop: Finish: BOSNIA GREY Material: Sintered Stone Thickness: 12mm	台面: 颜色: 波西尼亚灰 基材: 岩板 厚度: 12mm
LED 3000k with smart switch 配遥控开关		

PC 代表自弹器 配悍高隐藏式自弹器, 工厂开孔  
未标注诺米编号的抽屉配木抽, DTC托底轨  
铰链DTC

# WAYMOVE

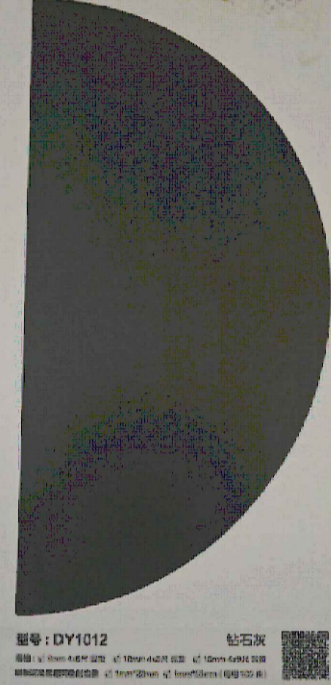
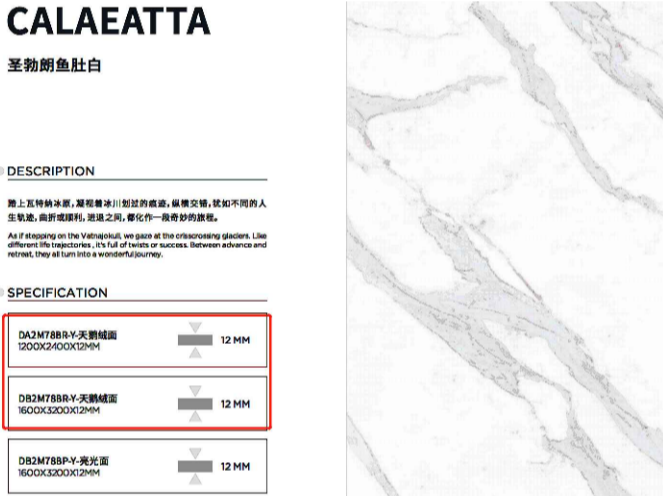

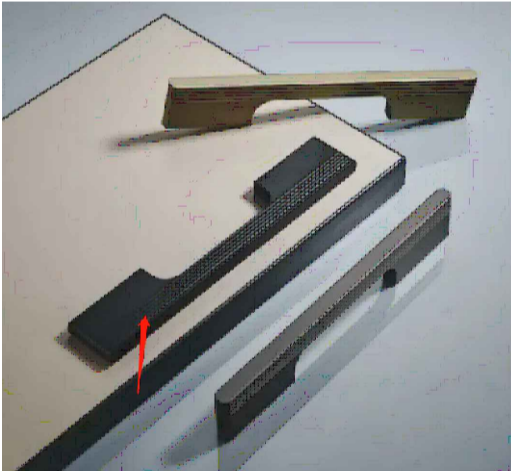
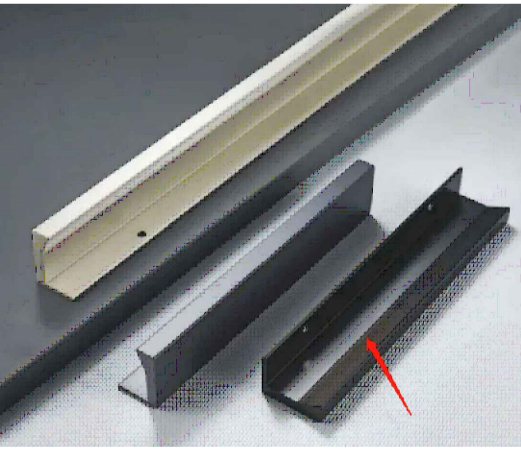
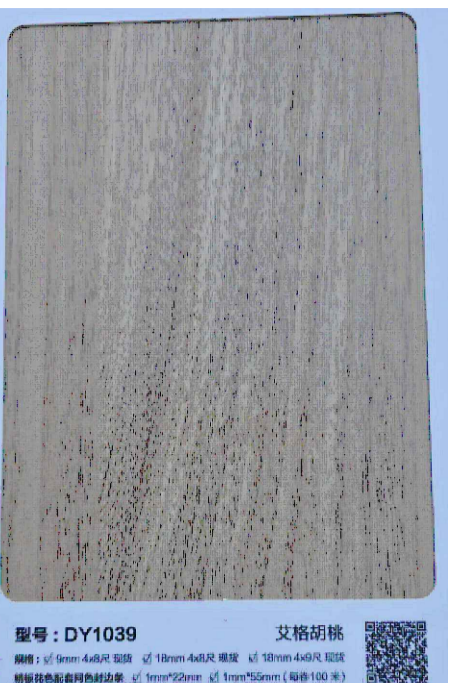
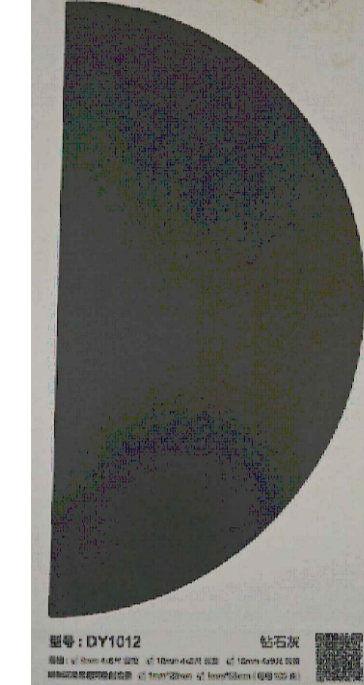
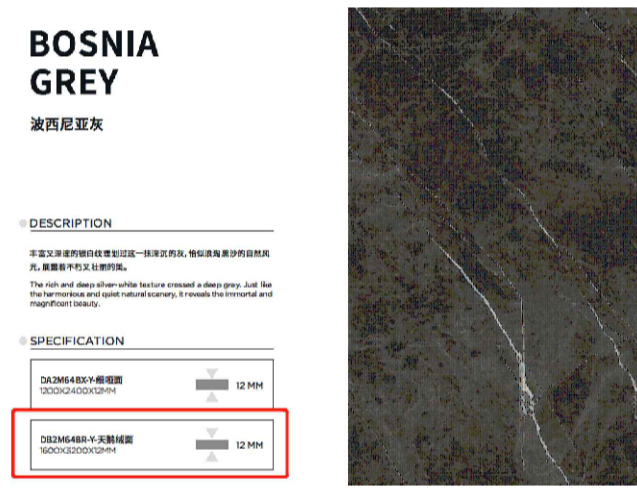
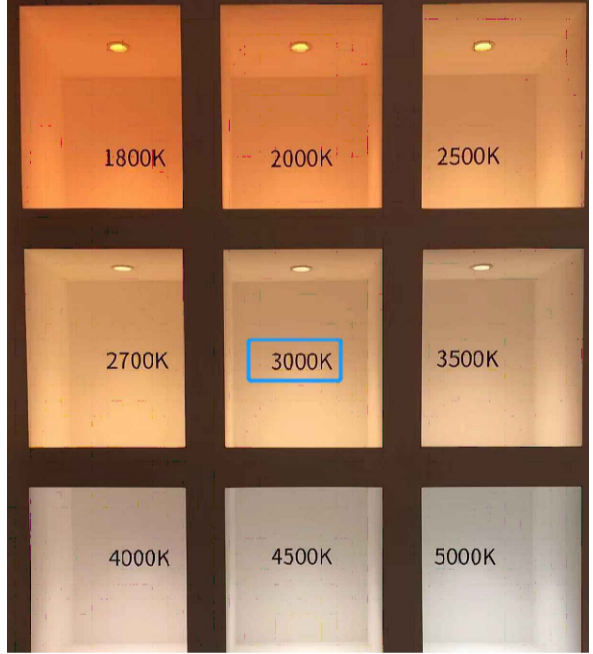
Order No: WMCA240919001

Client Name: Wylie

Email:

Client Address:

Room Space:

Carcass Material	
Door Material	
Door Shape	

Drawer Handle:

Door Handle:

Remark:

Design Date:

Lead Time: 10-12 Weeks

Consignee:

Date:

Designer:

Tel:

# Kitchen

# WAYMOVE



Order No: WMCA240919001

Client Name: Wylie

Email:

Client Address:

Room Space: KITCHEN

Carcass Material	
Door Material	
Door Shape	

Drawer Handle:

Door Handle:

Remark:

Design Date:

Lead Time: 10-12 Weeks

Consignee:

Date:

Designer:

Tel:

Pages 1

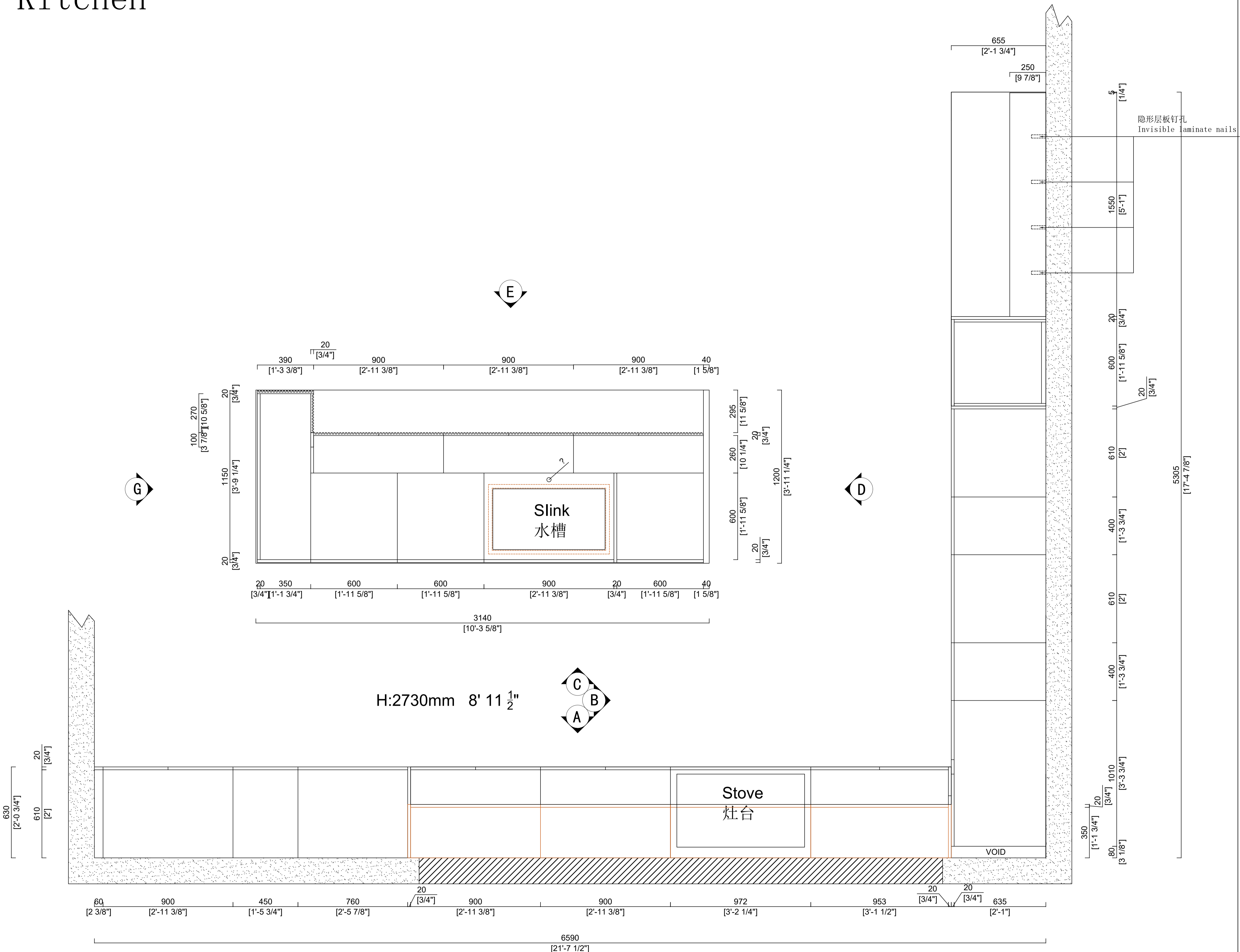

# Kitchen

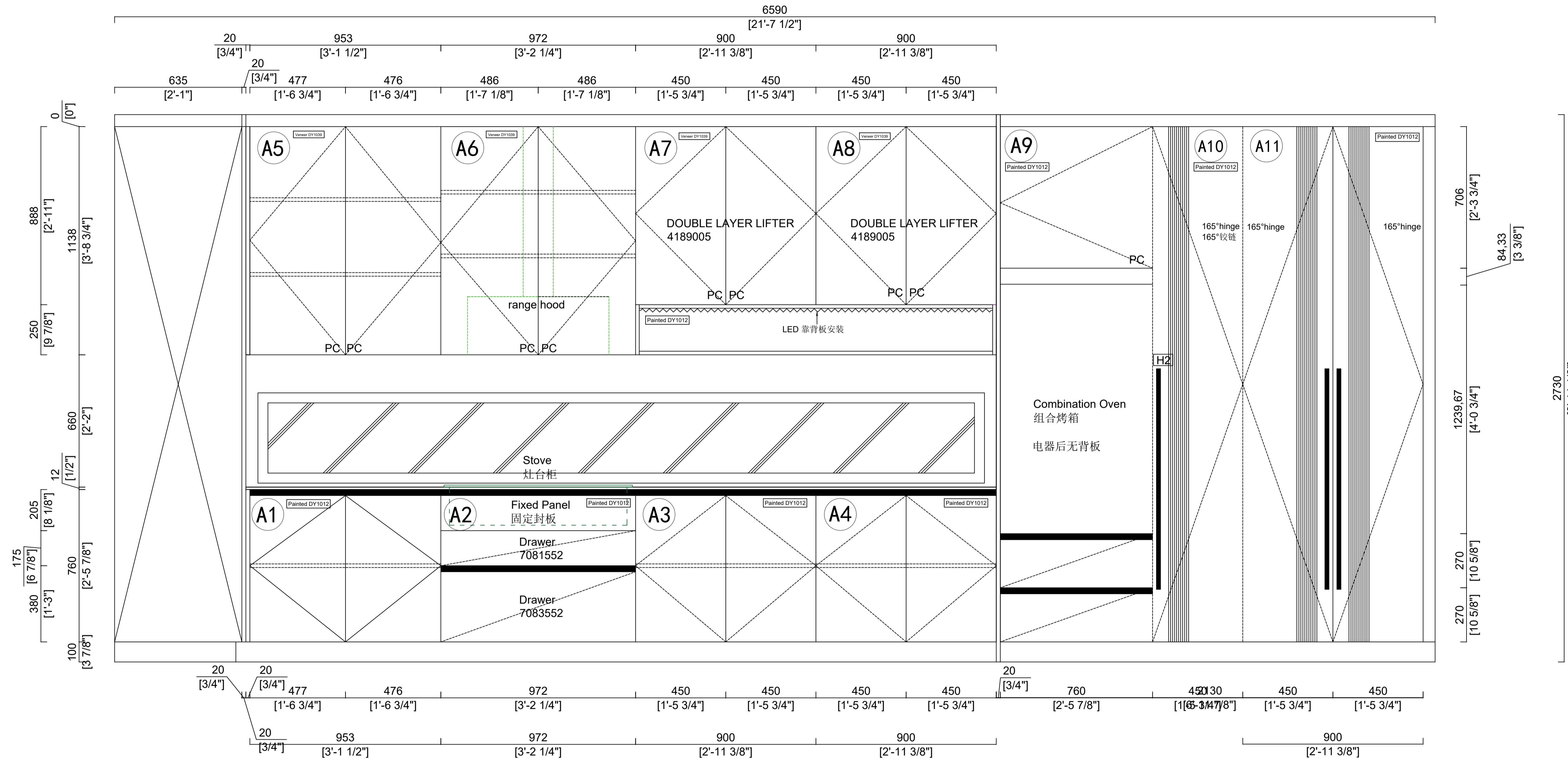

**ELEVATION A**

**WAYMOVE**

Order No: WMCA240919001

Client Name: Wylie

Email:

Client Address:

Room Space: KITCHEN

Carcass Material	
Door Material	
Door Shape	

Drawer Handle:

Door Handle:

Remark:

Design Date:

Lead Time: 10-12 Weeks

Consignee:

Date:

Designer:

Tel:

# Kitchen

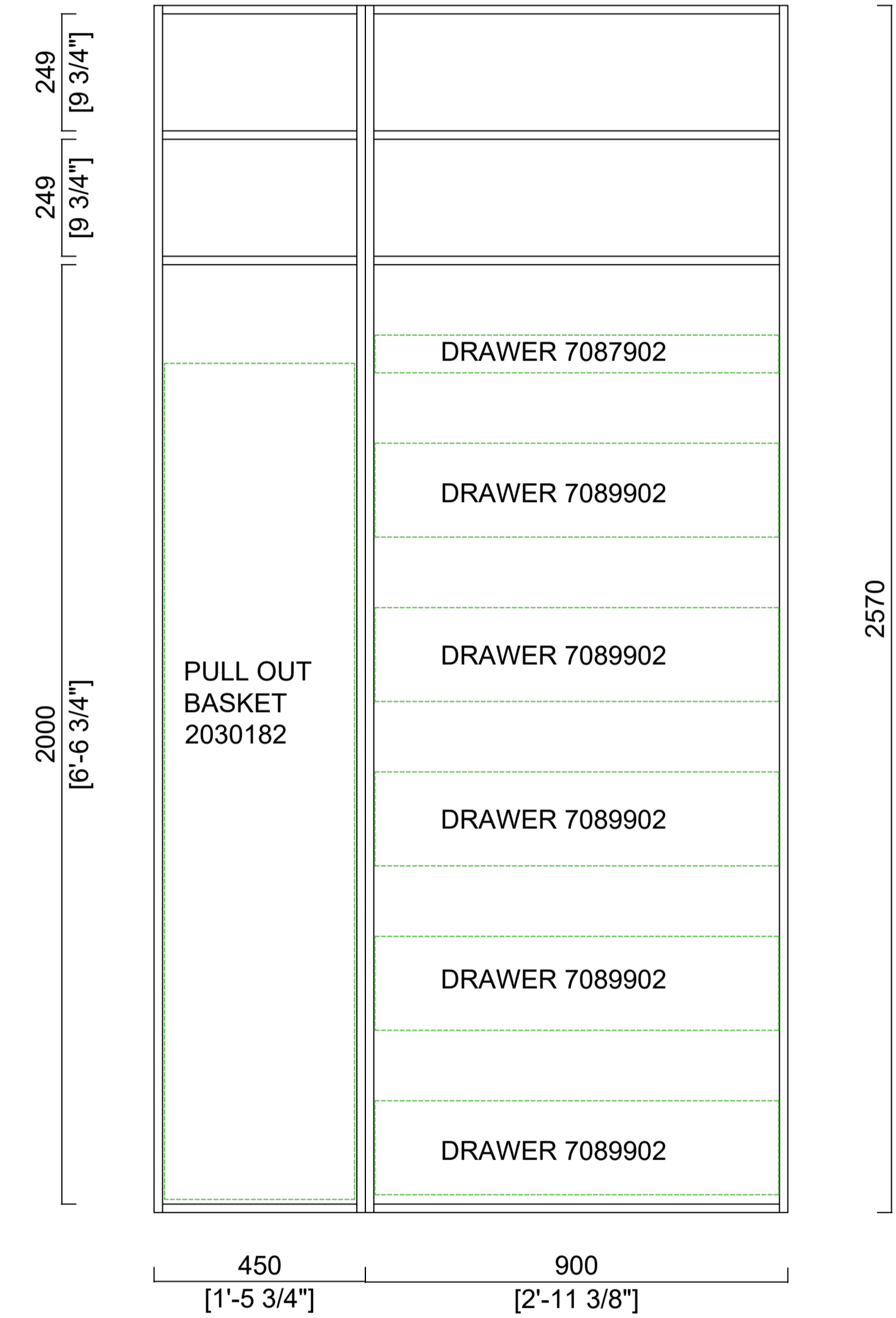
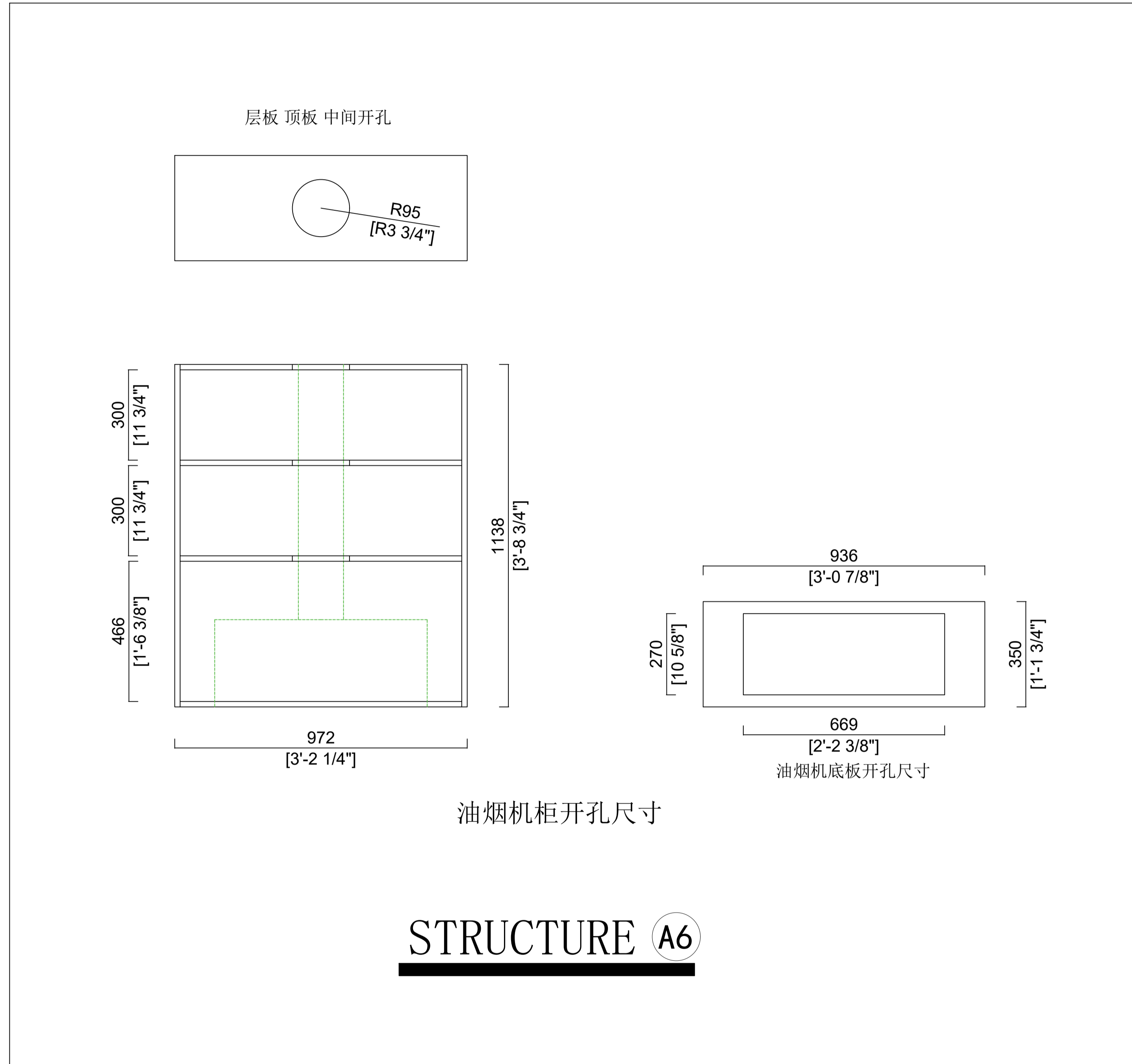

## WAYMOVE

Order No: WMCA240919001

Client Name: Wylie

Email:

Client Address:

Room Space: KITCHEN

Carcass Material	<input checked="" type="checkbox"/>
Door Material	<input type="checkbox"/>
Door Shape	<input checked="" type="checkbox"/>

Drawer Handle:

Door Handle:

Remark:

Design Date:

Lead Time: 10-12 Weeks

Consignee:

Date:

Designer:

Tel:

Pages 3

# Kitchen

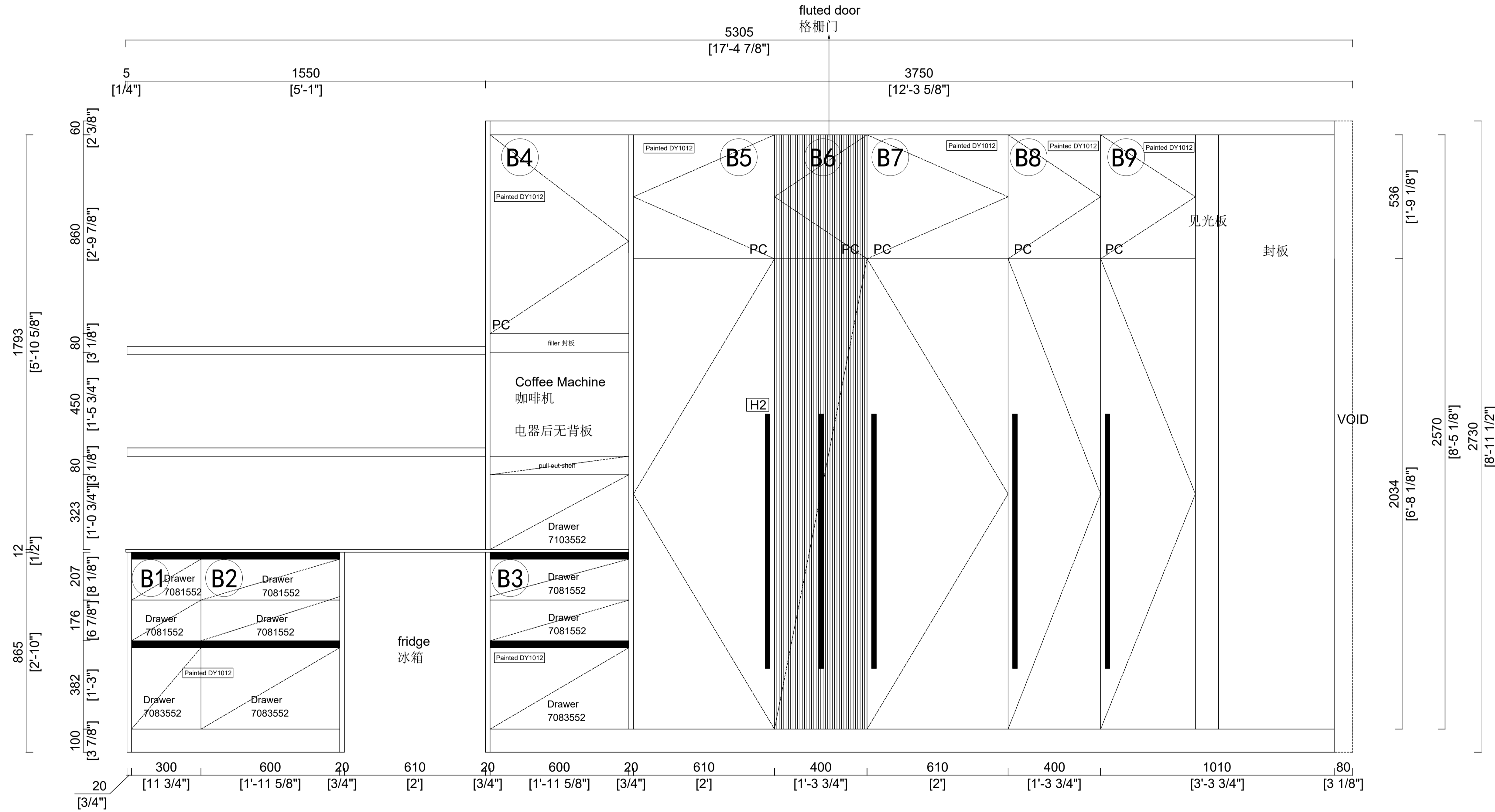

**ELEVATION B**

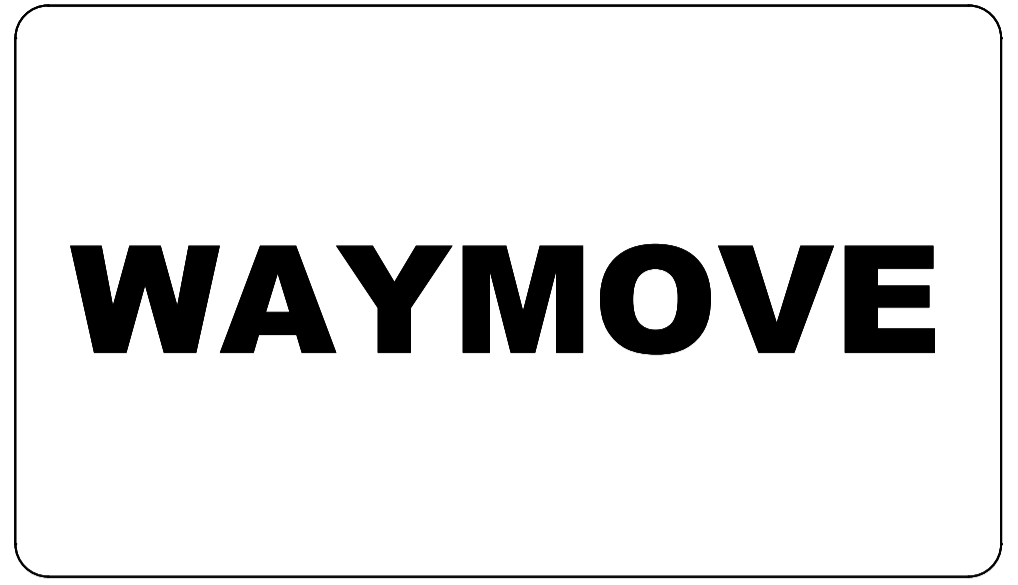

Order No: WMCA240919001	
Client Name: Wylie	
Email:	
Client Address:	
Room Space: KITCHEN	
Carcass Material	<input checked="" type="checkbox"/>
Door Material	<input type="checkbox"/>
Door Shape	<input checked="" type="checkbox"/>
Drawer Handle:	
Door Handle:	
Remark:	
Design Date:	
Lead Time: 10-12 Weeks	
Consignee:	
Date:	
Designer:	
Tel:	
Pages	4

# Kitchen

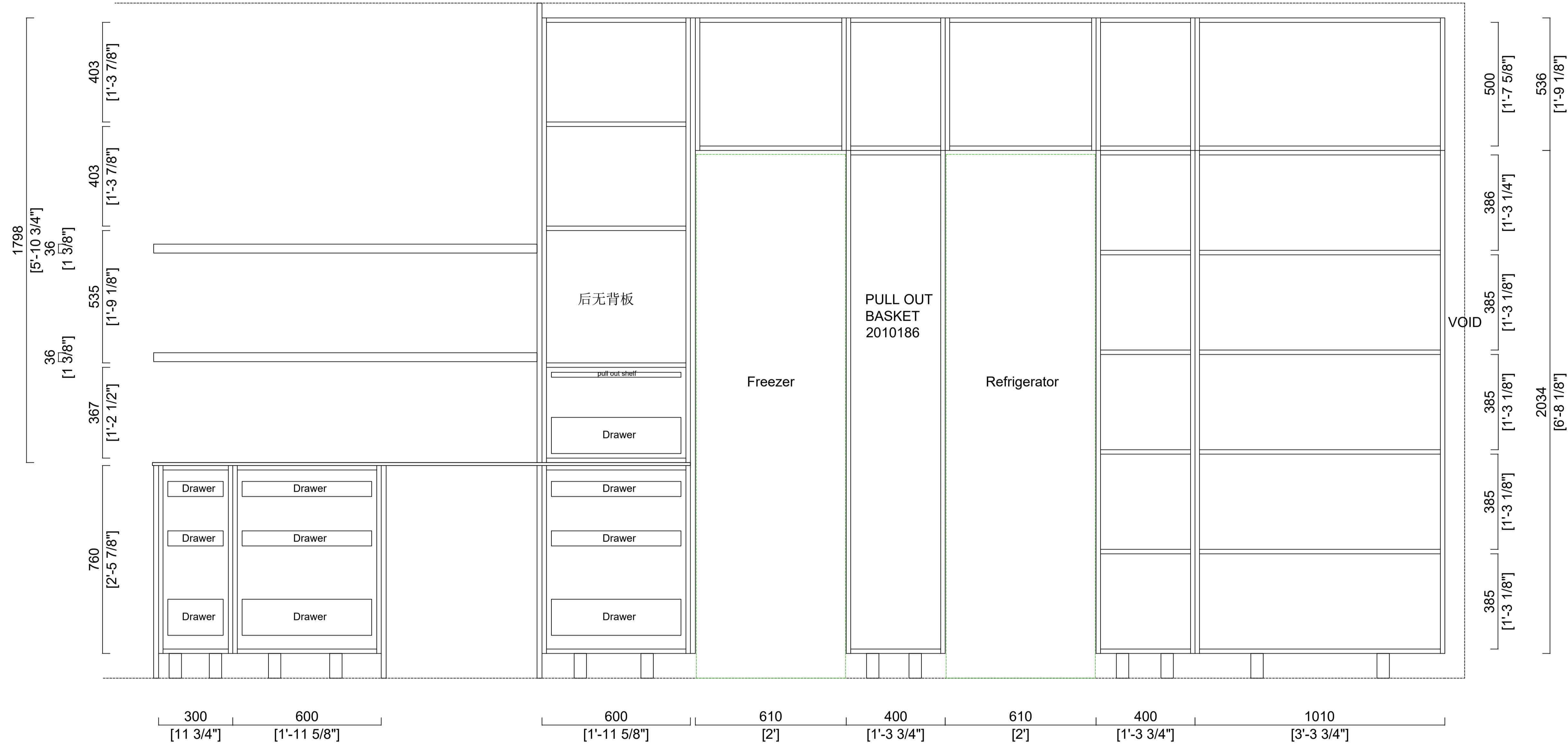

## STRUCTURE B

**WAYMOVE**

Order No: WMCA240919001

Client Name: Wylie

Email:

Client Address:

Room Space: KITCHEN

Carcass Material	<input checked="" type="checkbox"/>
Door Material	<input type="checkbox"/>
Door Shape	<input checked="" type="checkbox"/>

Drawer Handle:

Door Handle:

Remark:

Design Date:

Lead Time: 10-12 Weeks

Consignee:

Date:

Designer:

Tel:

Pages 5

# Kitchen

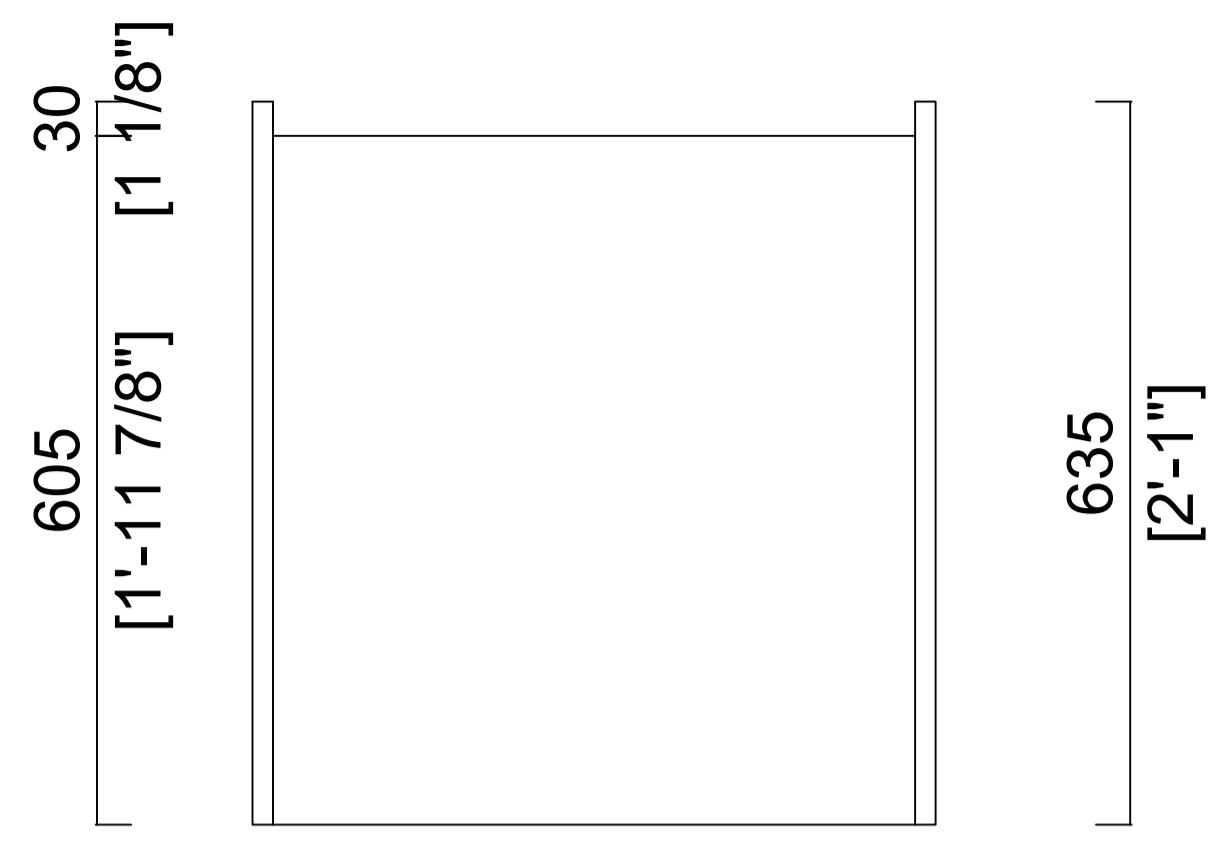

PLAN

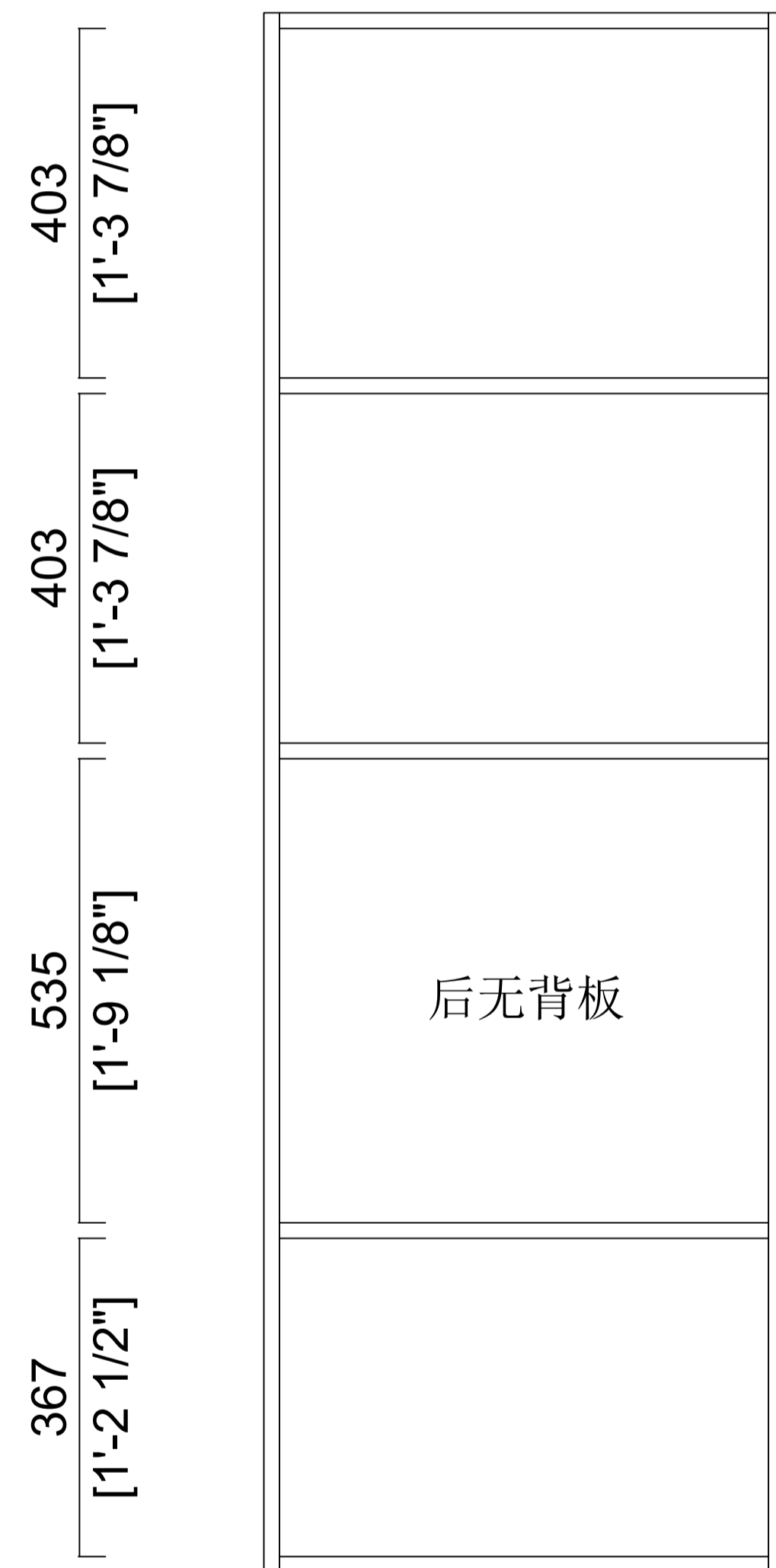

600 [1'-11 5/8"]

ELEVATION

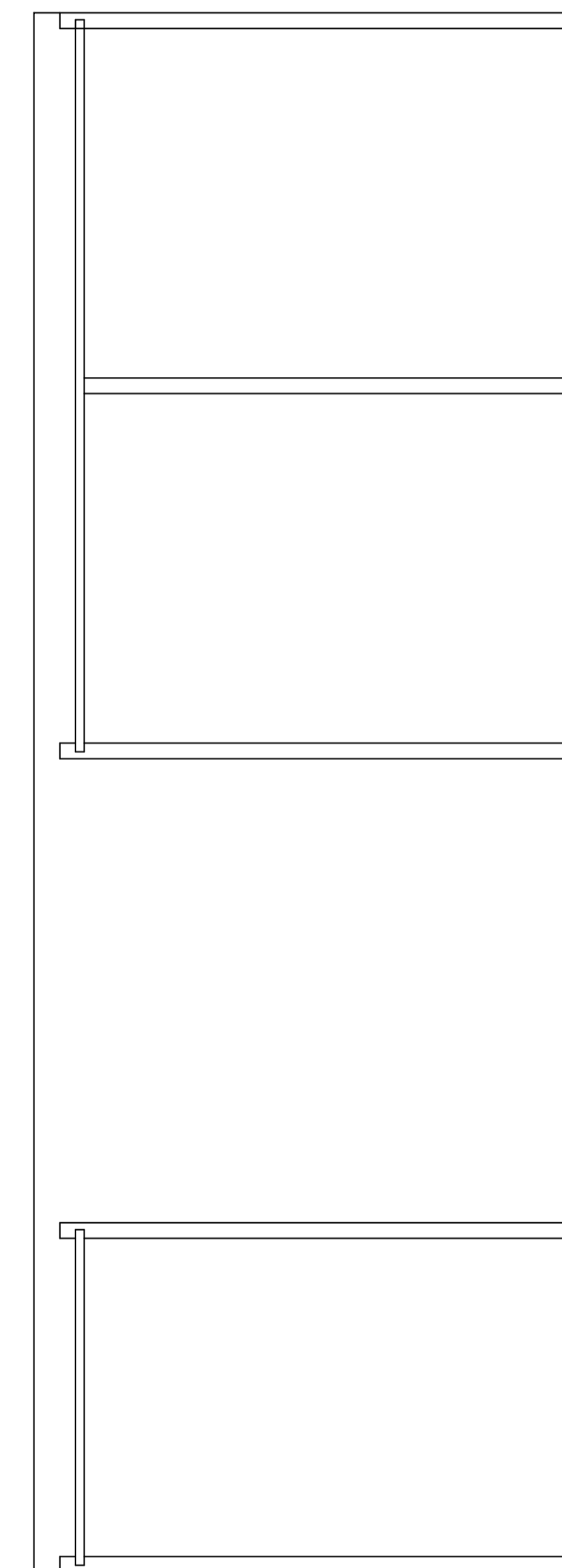

30 [1 1/8"] 605 [1'-11 7/8"]

SIDE VIEW

**STRUCTURE** (B4)

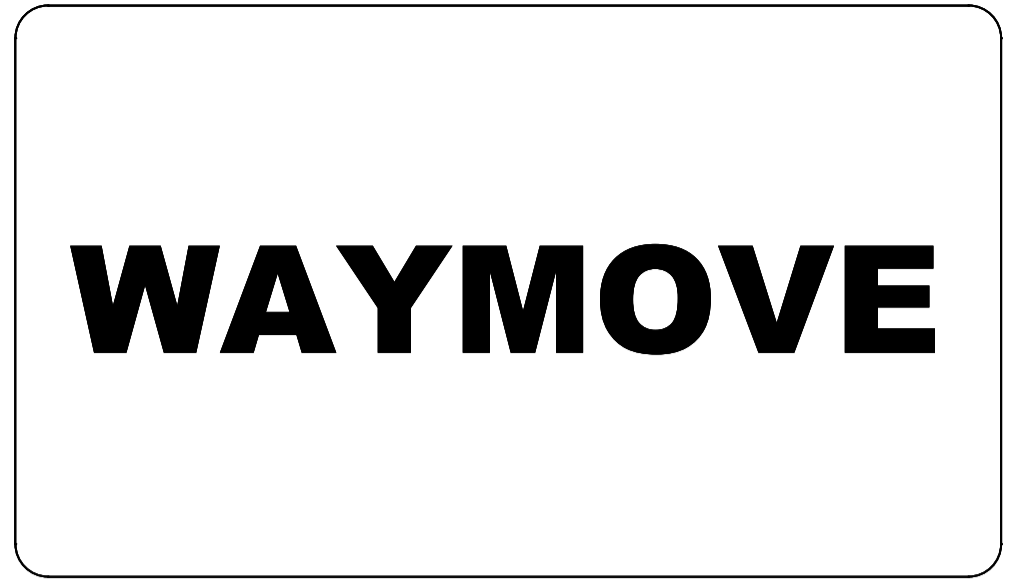

Order No: WMCA240919001

Client Name: Wylie

Email:

Client Address:

Room Space: KITCHEN

Carcass Material	
Door Material	
Door Shape	

Drawer Handle:

Door Handle:

Remark:

Design Date:

Lead Time: 10-12 Weeks

Consignee:  
Date:

Designer:  
Tel:

Pages 6

# Kitchen

# WAYMOVE

Order No: WMCA240919001

Client Name: Wylie

Email:

Client Address:

Room Space: KITCHEN

Carcass Material	<input checked="" type="checkbox"/>
Door Material	<input checked="" type="checkbox"/>
Door Shape	<input checked="" type="checkbox"/>

Drawer Handle:

Door Handle:

Remark:

Design Date:

Lead Time: 10-12 Weeks

Consignee:

Date:

Designer:

Tel:

Pages 7

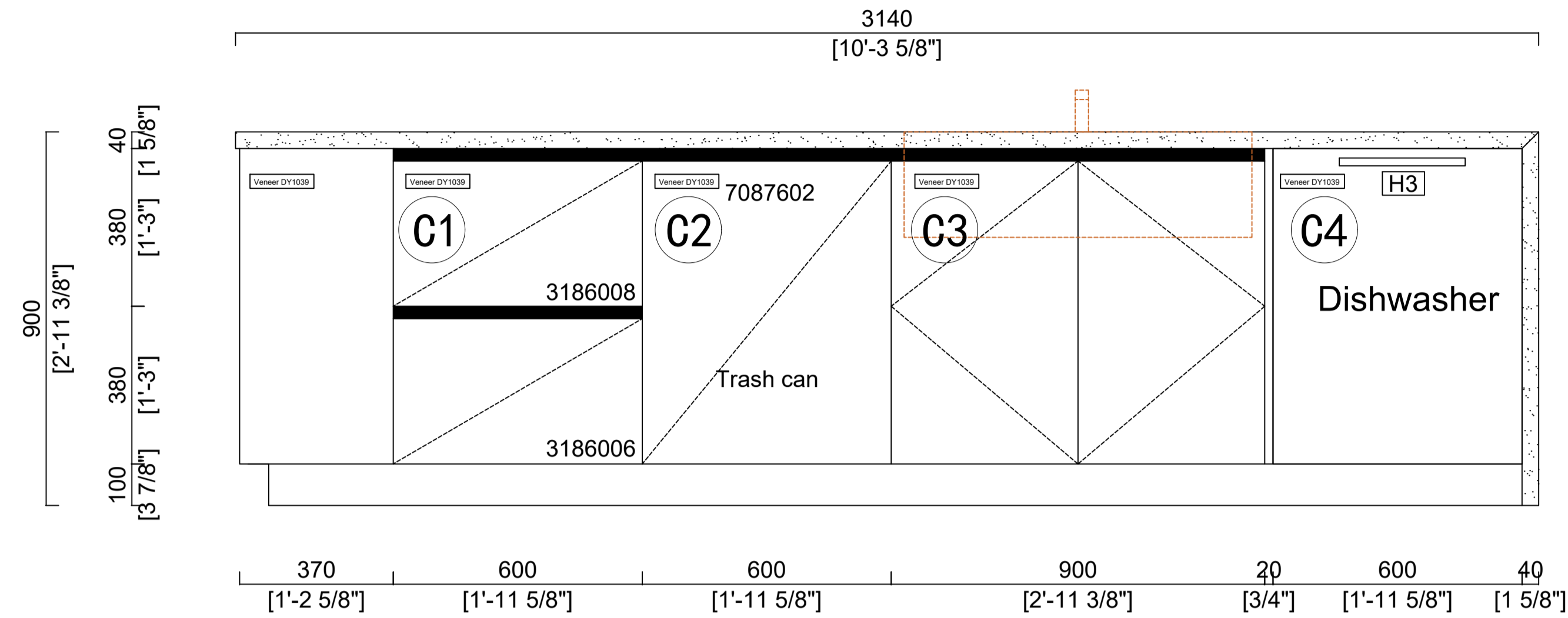

**ELEVATION C**

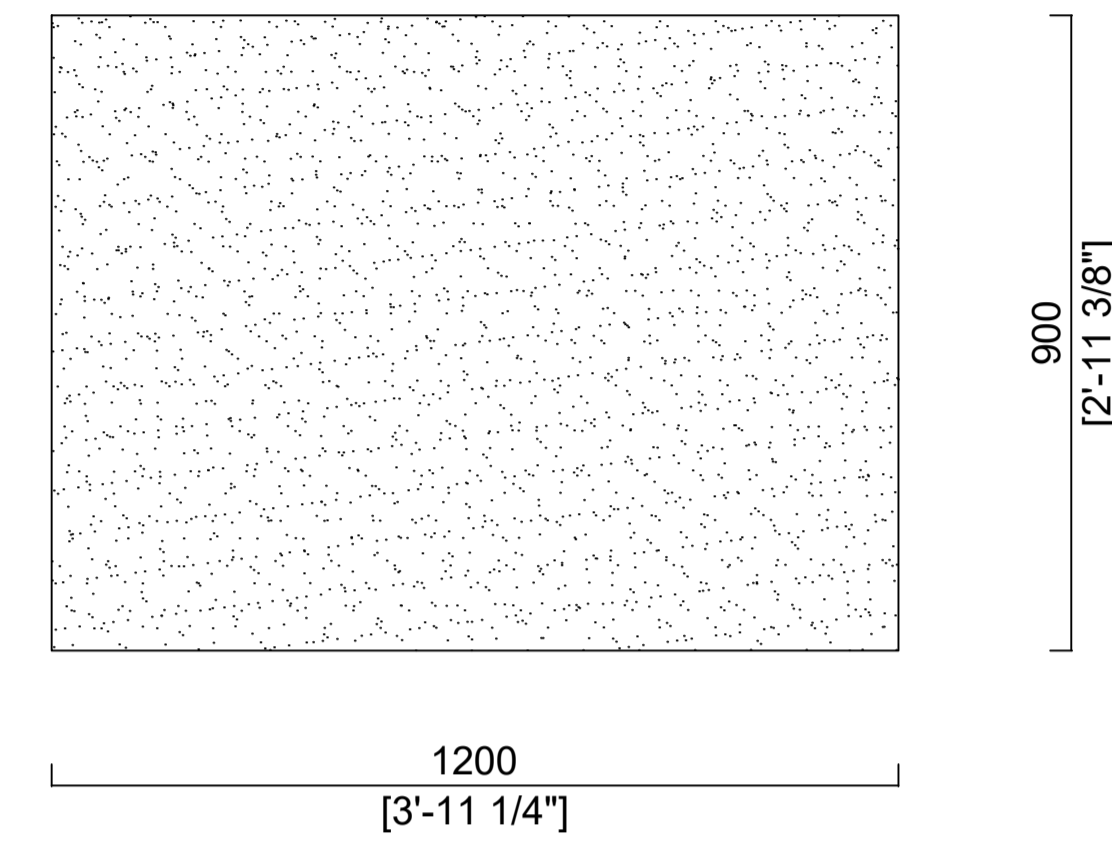

**ELEVATION D**

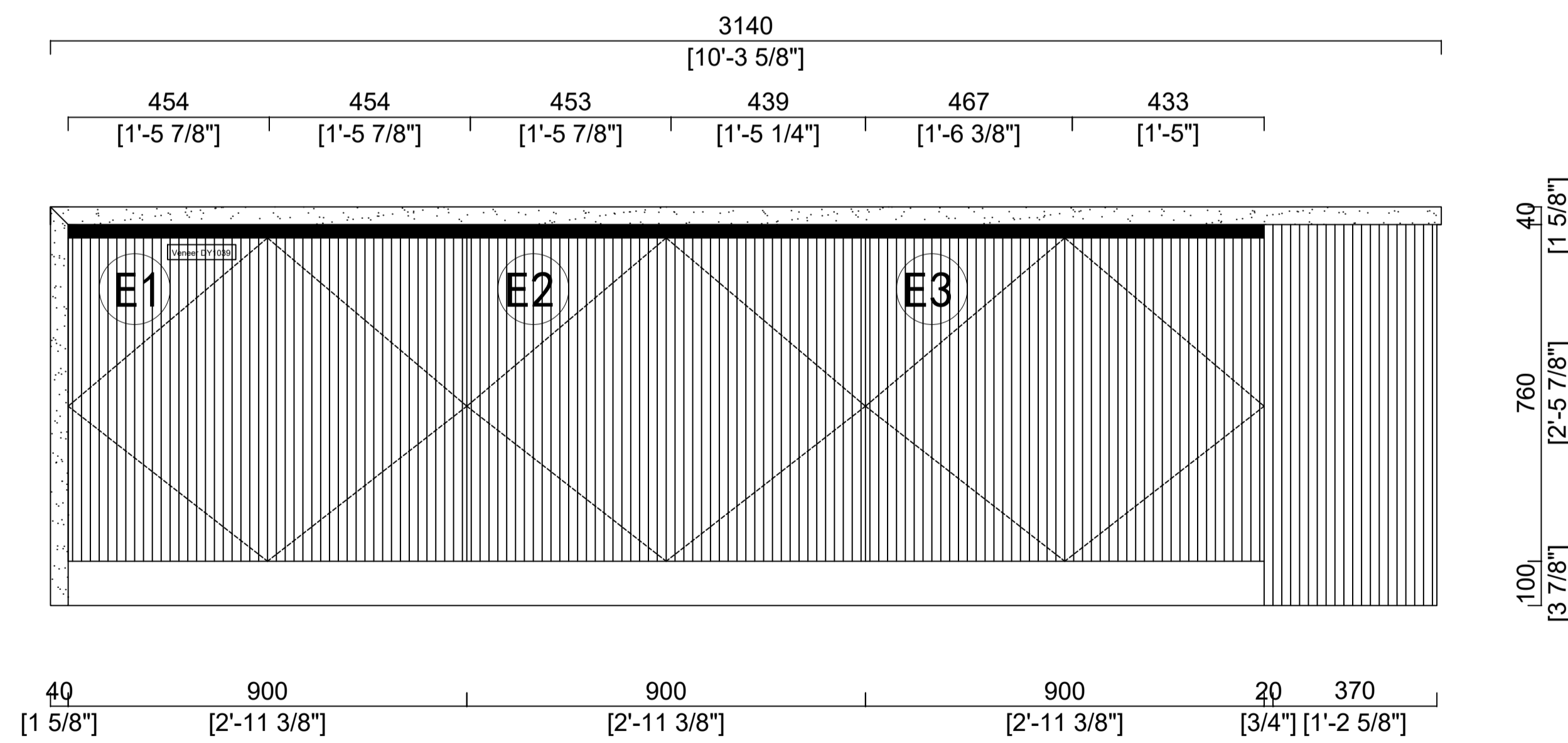

**ELEVATION E**

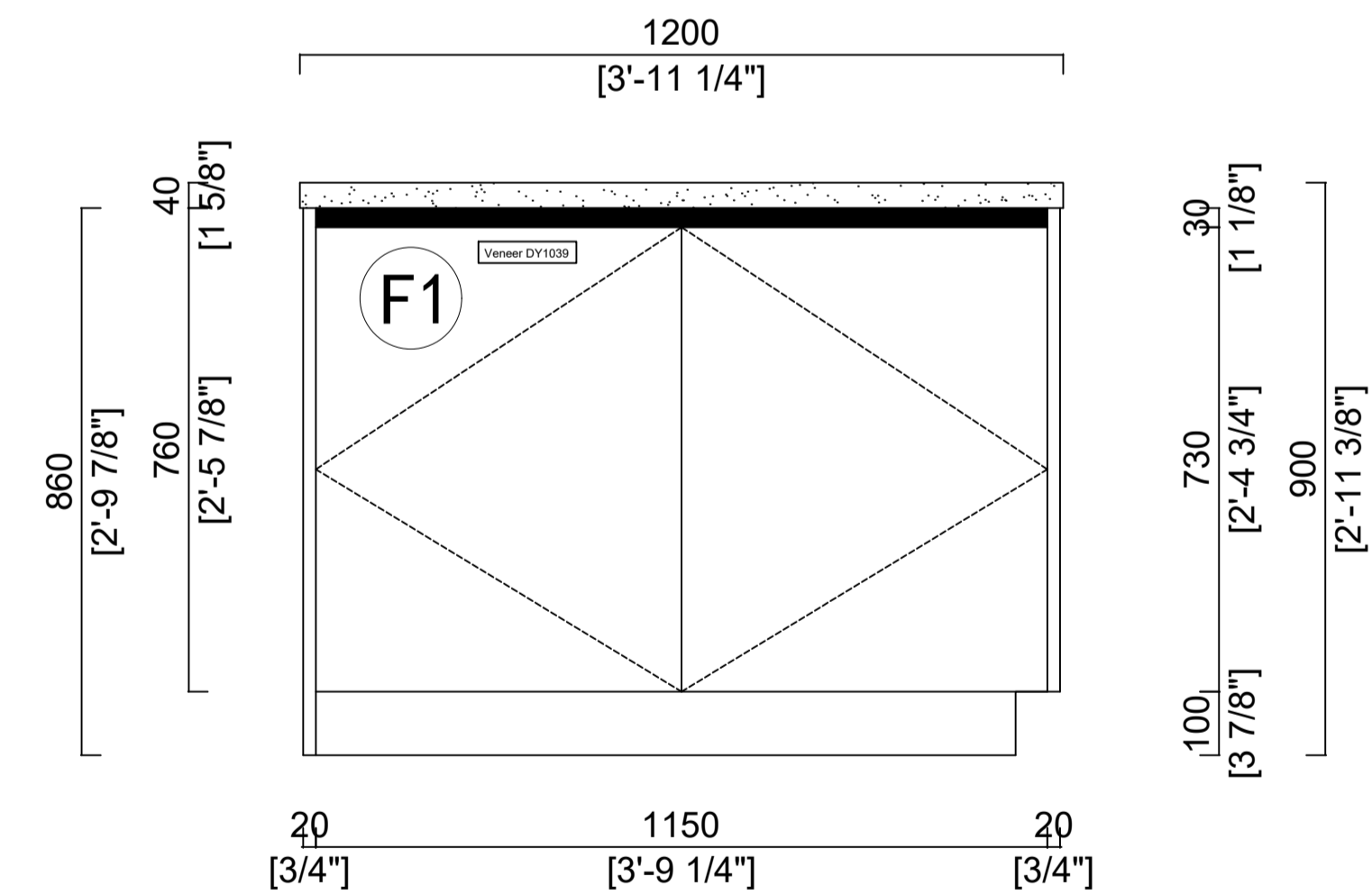

**ELEVATION F**

# Kitchen

灶具  
外形尺寸: 940\*540\*105mm  
开孔尺寸: 884\*506  
水槽  
外形尺寸: 838\*483\*254mm  
开孔尺寸: 787\*432\*239mm  
台下盆  
水龙头直径: 26mm

台面型号: 圣勃朗鱼肚白  
厚度: 12mm  
岛台下挂40mm

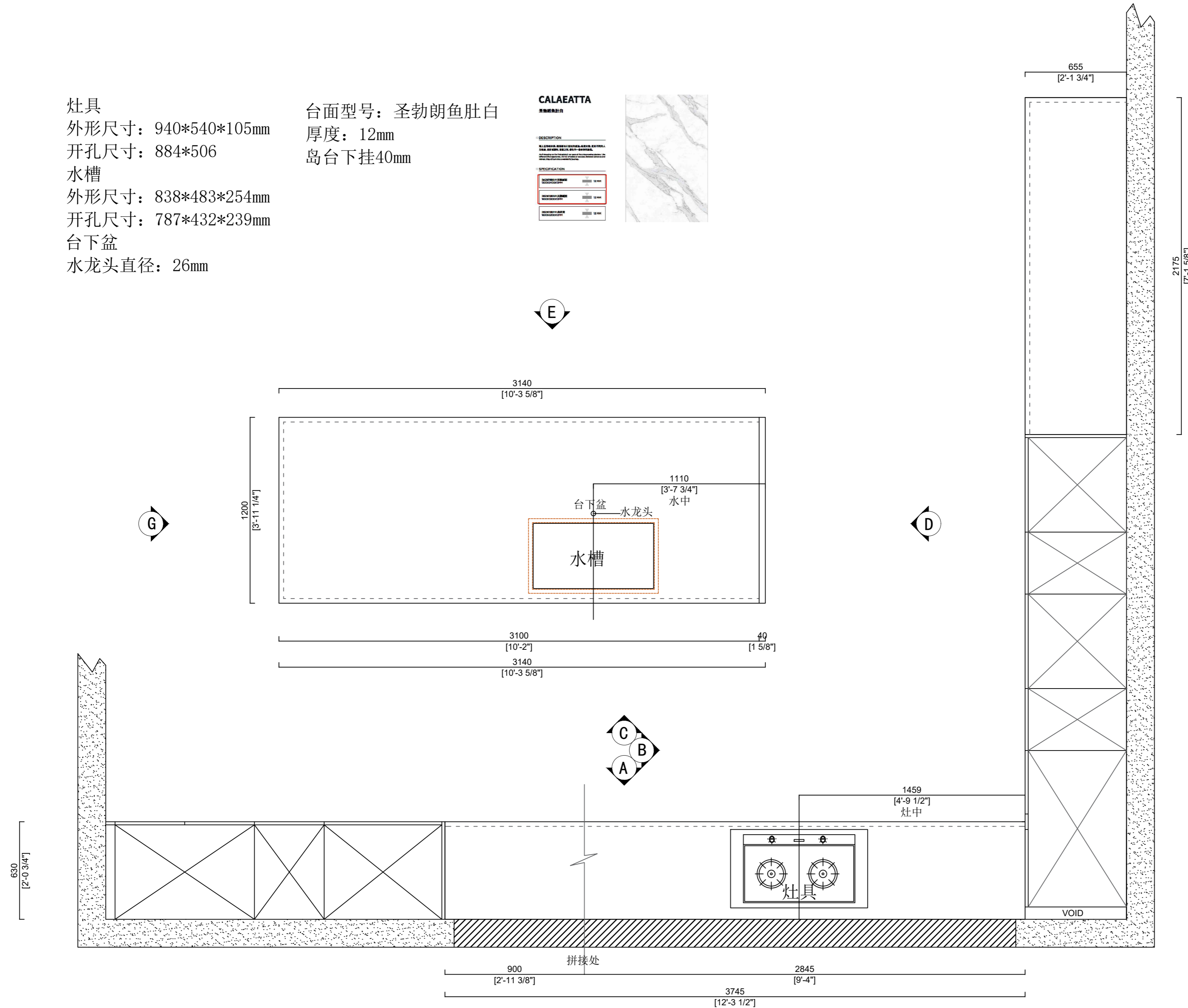
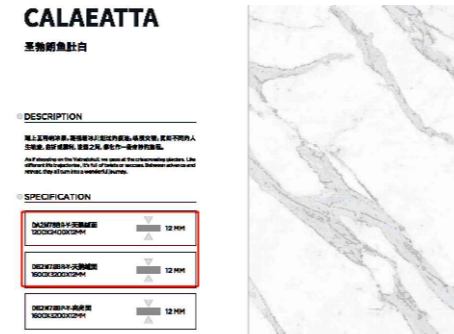

# WAYMOVE

Order No: WMCA240919001

Client Name: Wylie

Email:

Client Address:

Room Space: KITCHEN

Carcass Material	<input checked="" type="checkbox"/>
Door Material	<input type="checkbox"/>
Door Shape	<input checked="" type="checkbox"/>

Drawer Handle:

Door Handle:

Remark:

Design Date:

Lead Time: 10-12 Weeks

Consignee:  
Date:

Designer:  
Tel:

Pages

# Laundry

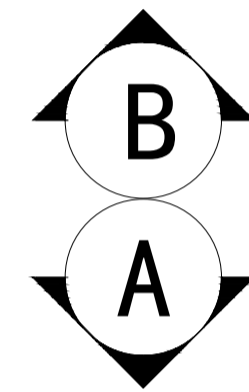
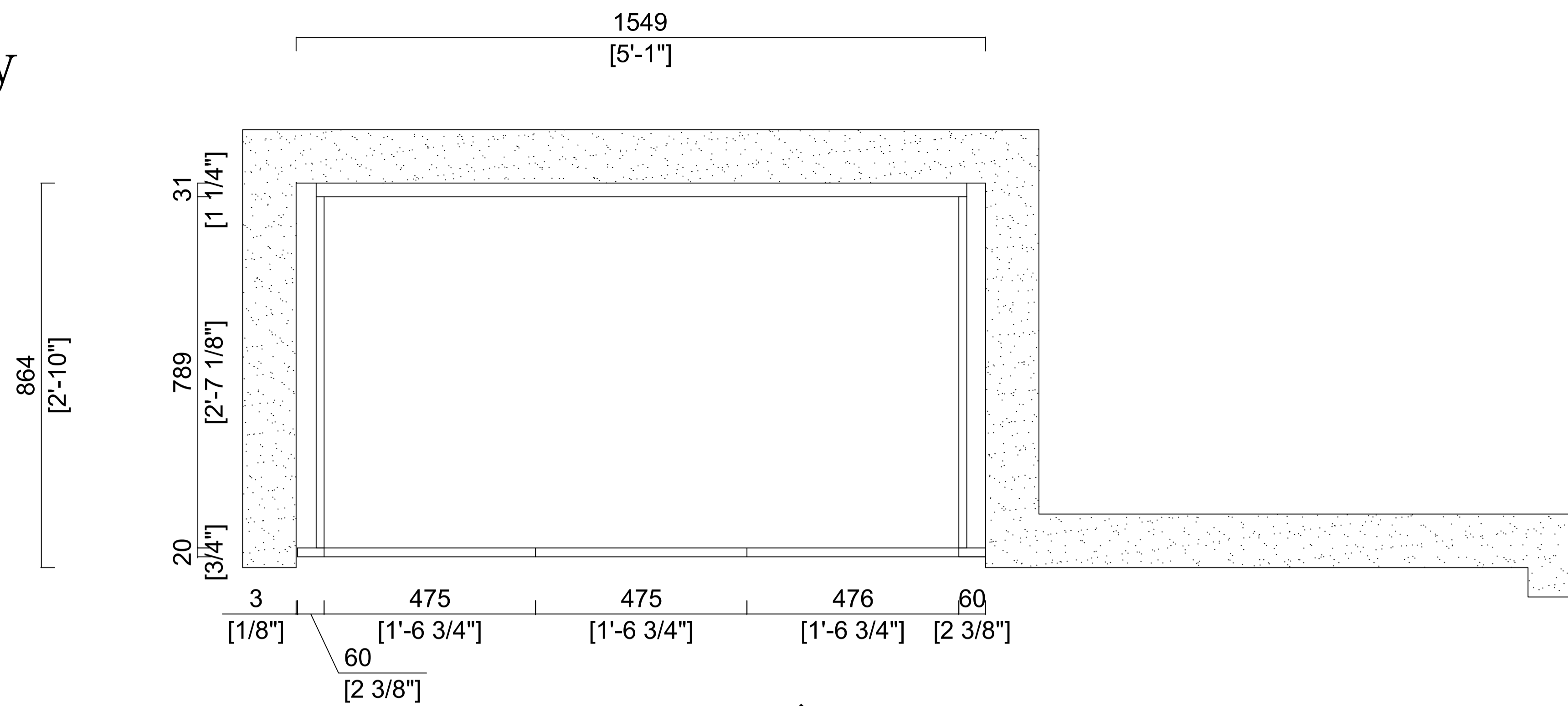

H:2730mm 8' 11 1/2"

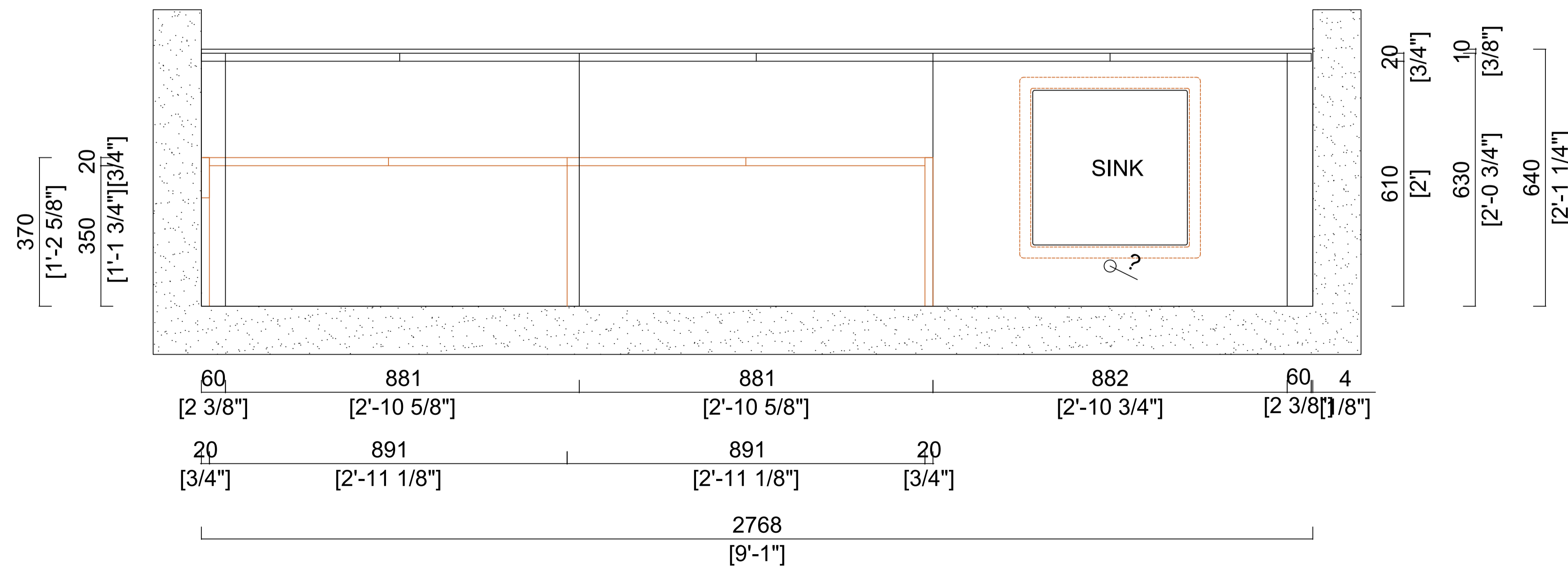

PLAN

## WAYMOVE

Order No: WMCA240919001

Client Name: Wylie

Email:

Client Address:

Room Space: LAUNDRY

Carcass Material	<input checked="" type="checkbox"/>
Door Material	<input checked="" type="checkbox"/>
Door Shape	<input checked="" type="checkbox"/>

Drawer Handle:

Door Handle:

Remark:

Design Date:

Lead Time: 10-12 Weeks

Consignee:

Date:

Designer:

Tel:

Pages 1

# Laundry

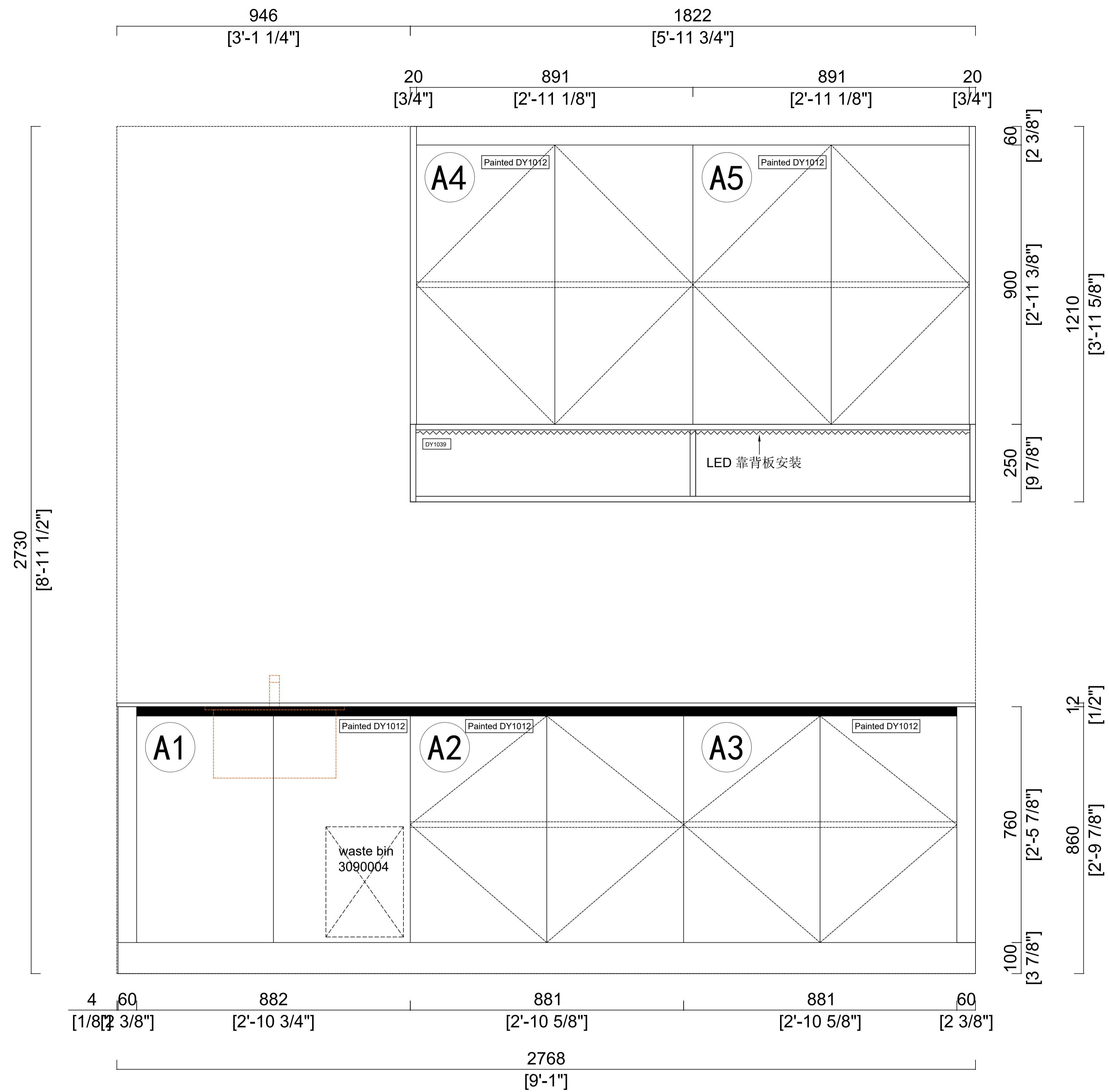

## ELEVATION A

**WAYMOVE**

Order No: WMCA240919001

Client Name: Wylie

Email:

Client Address:

Room Space: LAUNDRY

Carcass  
Material

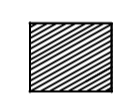

Door  
Material

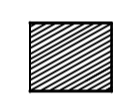
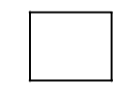

Door  
Shape

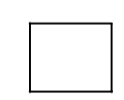
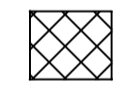

Drawer Handle:

Door Handle:

Remark:

Design Date:

Lead Time: 10-12 Weeks

Consignee:

Date:

Designer:

Tel:

Pages

2

# Laundry

# WAYMOVE

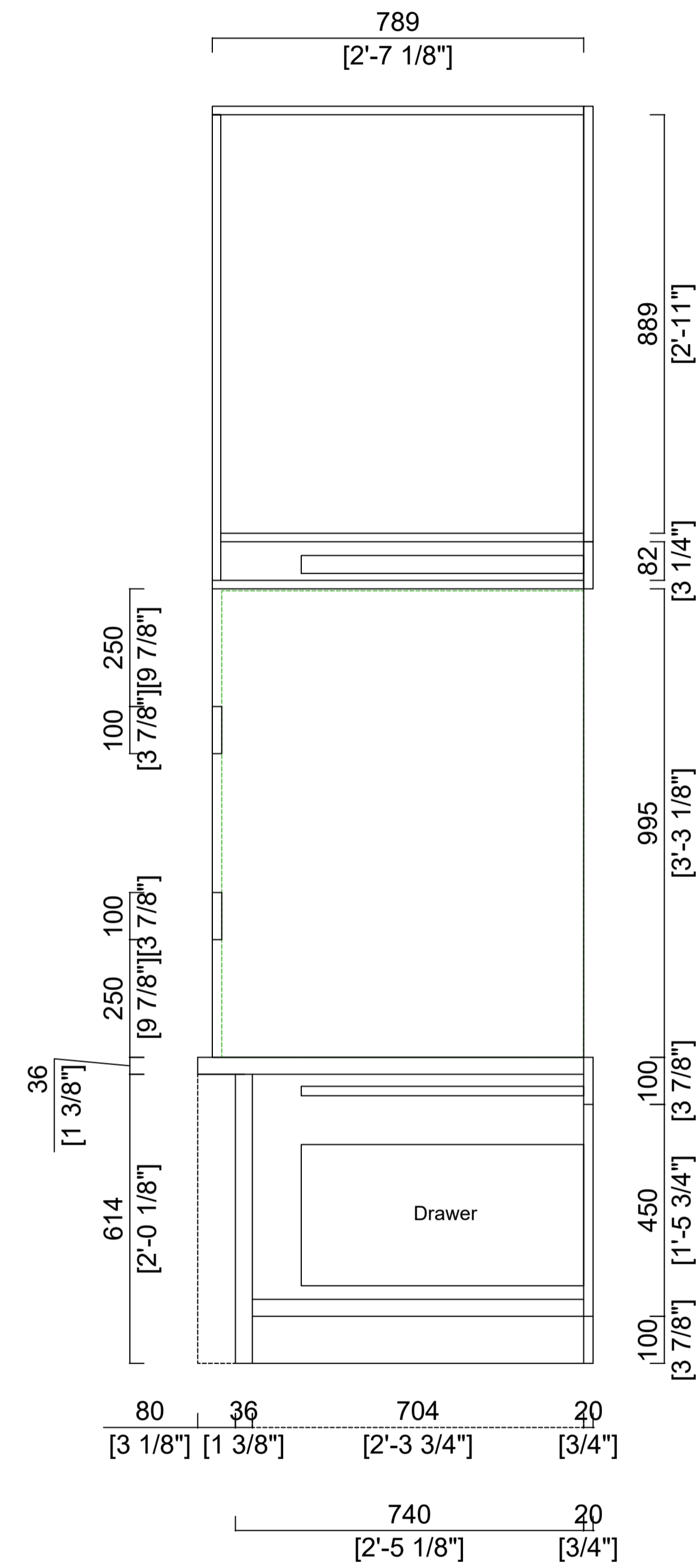
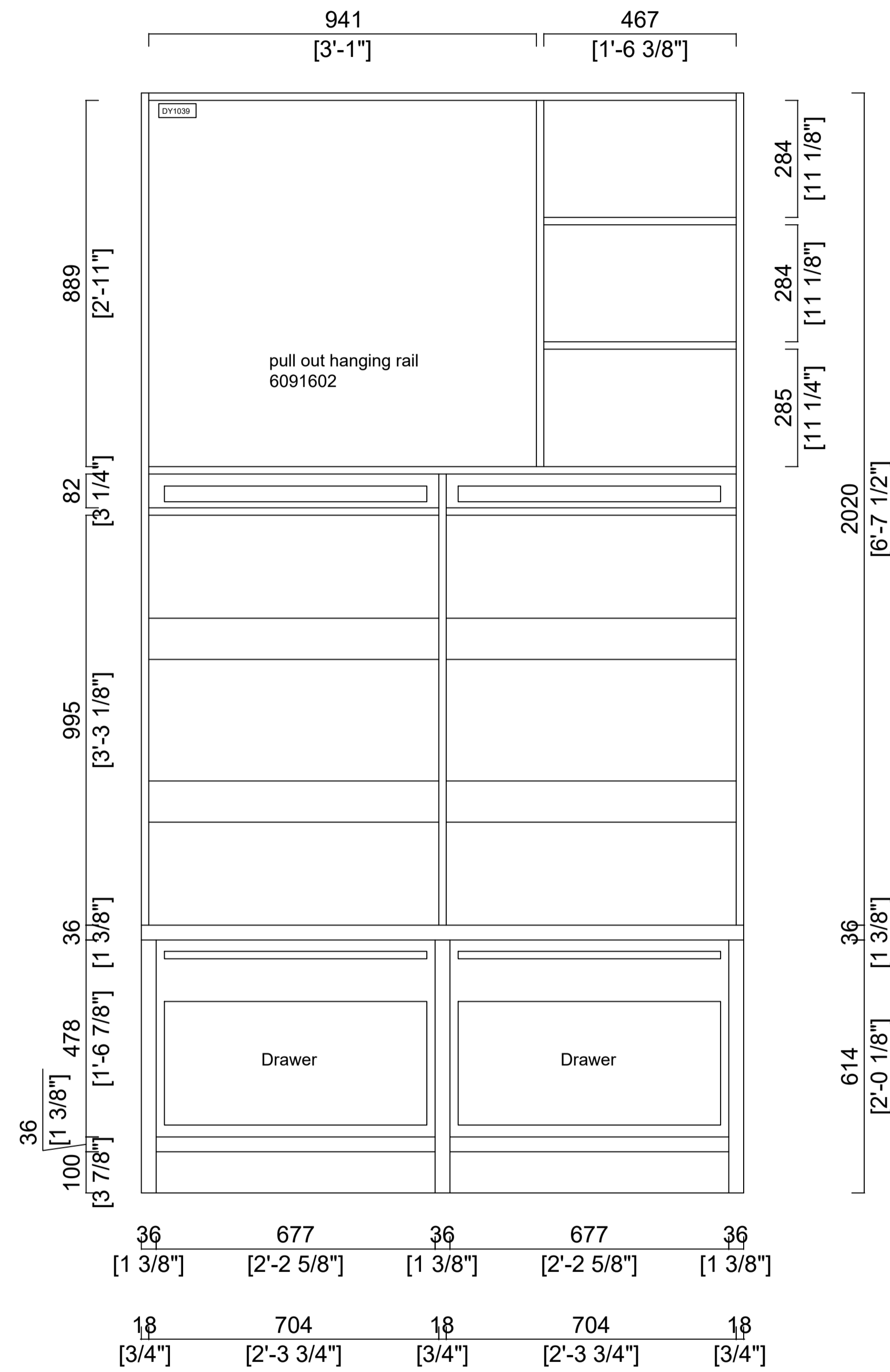
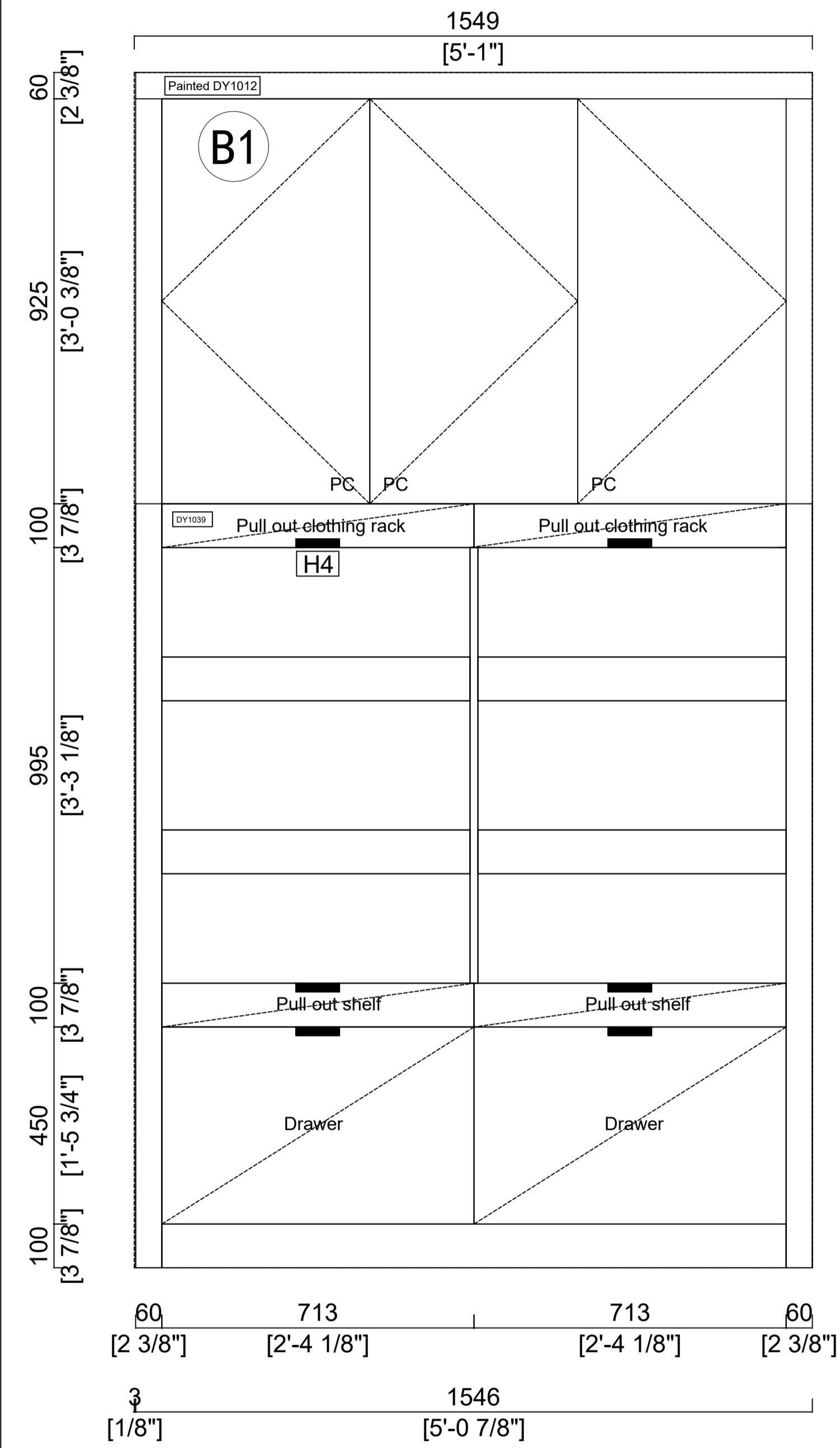

Order No: WMCA240919001

Client Name: Wylie

Email:

Client Address:

Room Space: LAUNDRY

Carcass Material	<input checked="" type="checkbox"/>
Door Material	<input type="checkbox"/>
Door Shape	<input checked="" type="checkbox"/>

Drawer Handle:

Door Handle:

Remark:

Design Date:

Lead Time: 10-12 Weeks

Consignee:

Date:

Designer:

Tel:

# Laundry

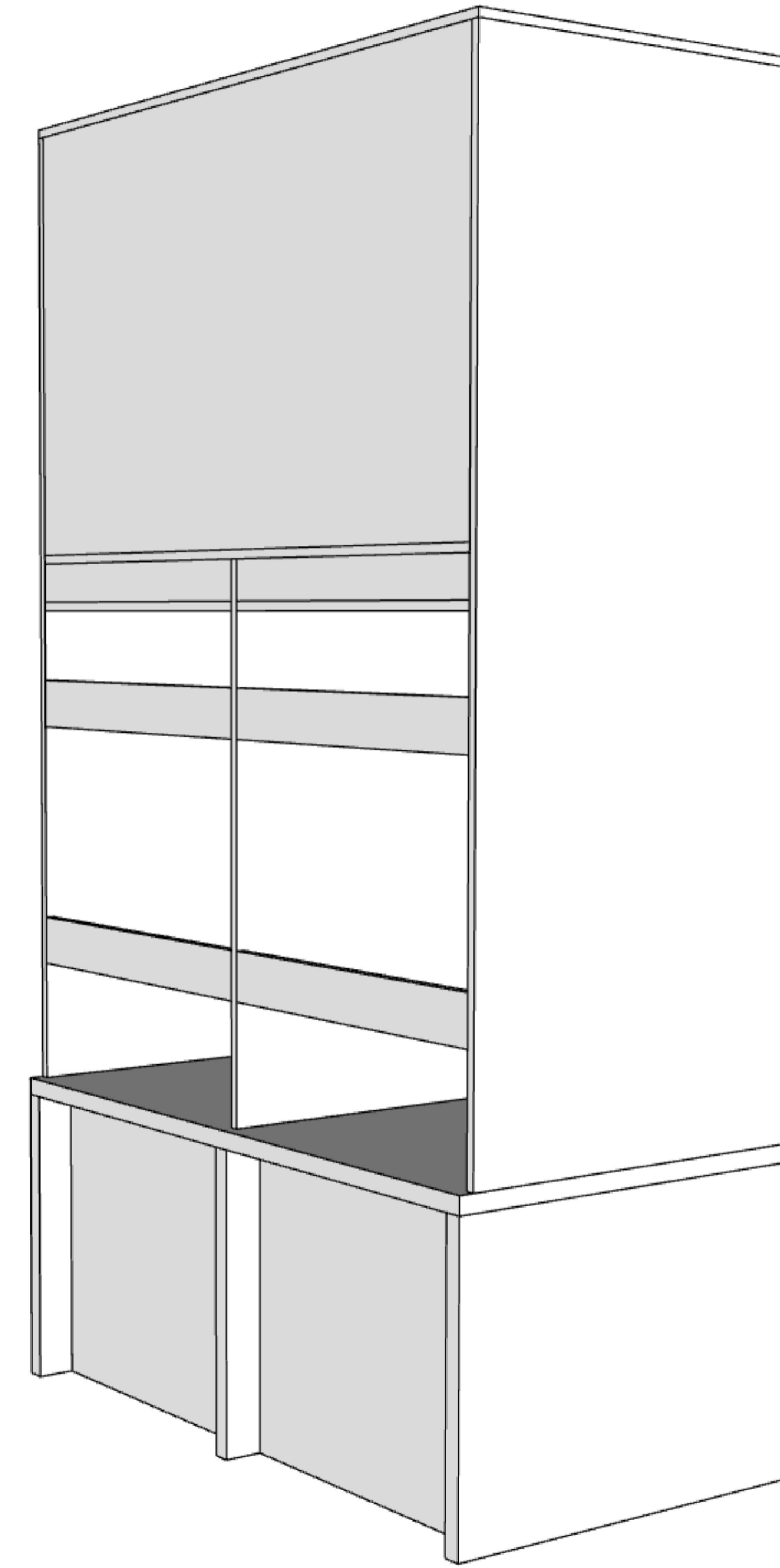
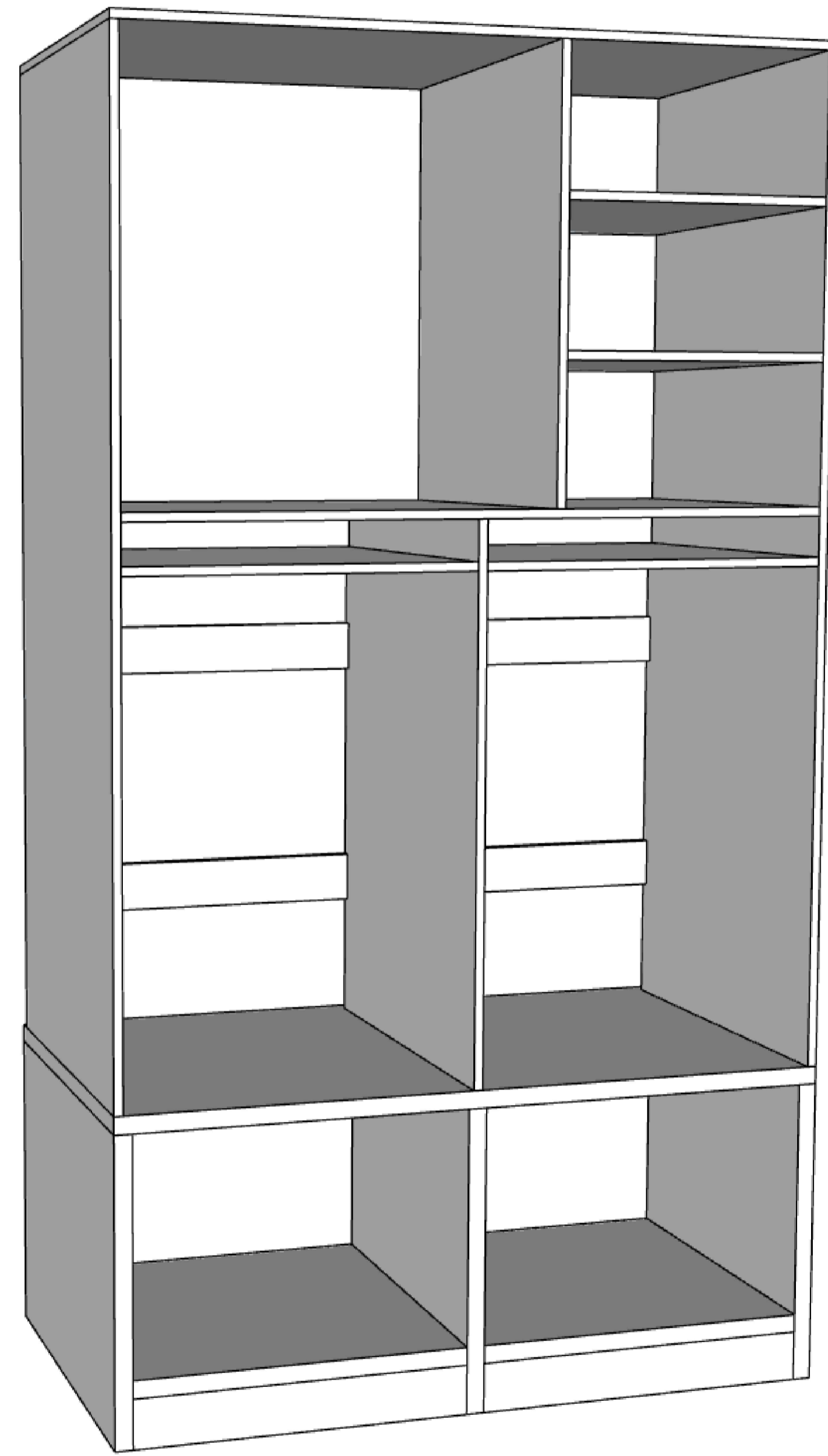
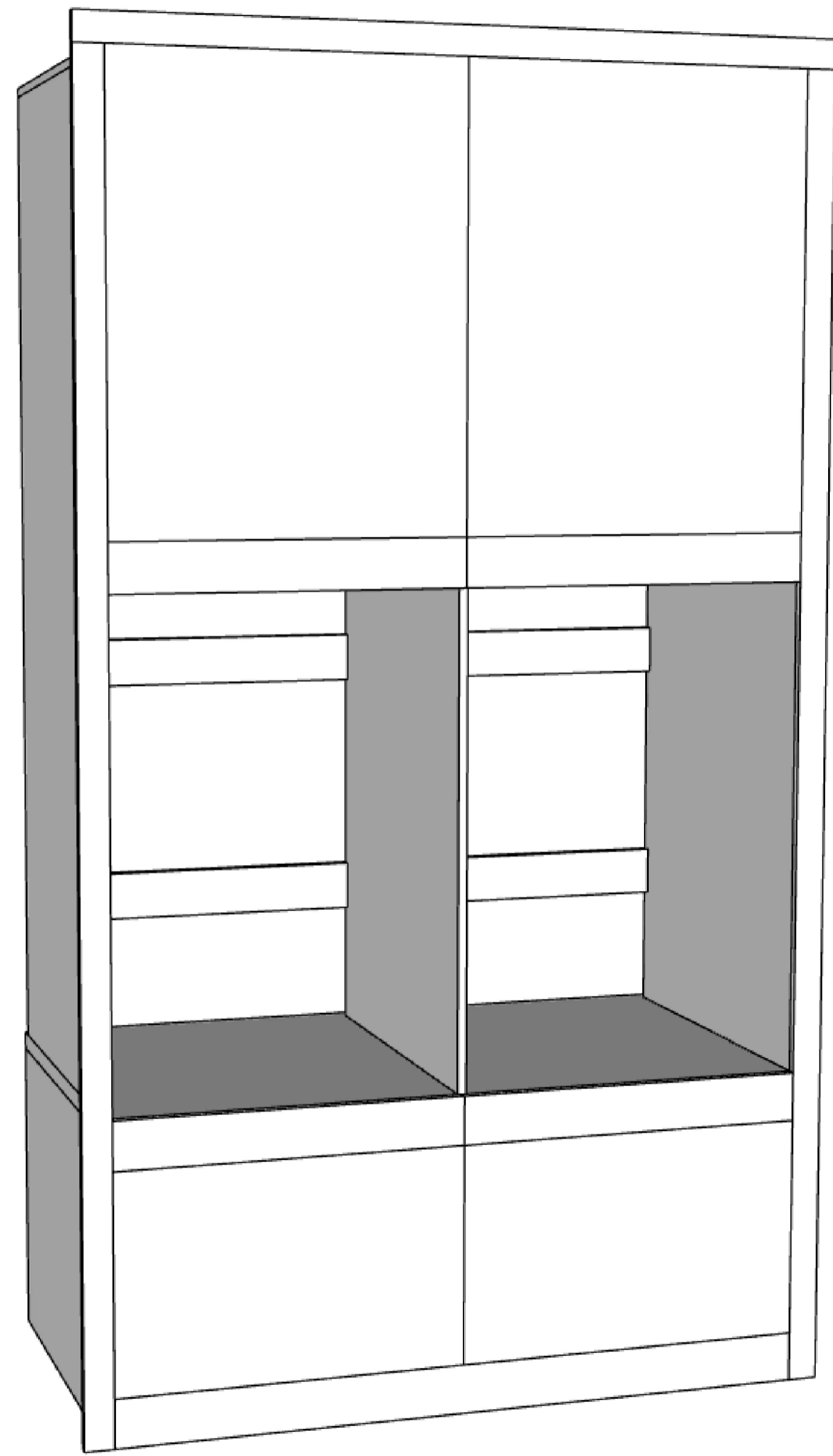

**WAYMOVE**

Order No: WMCA240919001

Client Name: Wylie

Email:

Client Address:

Room Space: LAUNDRY

Carcass  
Material

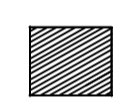

Door  
Material

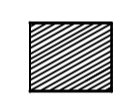
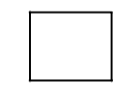

Door  
Shape

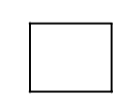
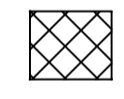

Drawer Handle:

Door Handle:

Remark:

Design Date:

Lead Time: 10-12 Weeks

Consignee:

Date:

Designer:

Tel:

Pages

4

# Laundry

水槽

外形尺寸: 450\*450mm

开孔尺寸: 395\*395mm

台下盆

水龙头直径: 26mm

台面型号: 圣勃朗鱼肚白

厚度: 12mm

## CALAEATTA

圣勃朗鱼肚白

### DESCRIPTION

踏上瓦特纳冰原, 穿越着冰川划过的痕迹, 纵横交错, 宛如不同的人  
生轨迹, 曲折或犀利, 迥迥之间, 都化作一段美好的旅程。

As if stepping on the Vatnajökull, we gaze at the ever-receding glaciers. Like  
different life trajectories, full of twists or success, setbacks, advance and  
retreat, they all turn into a wonderful journey.

### SPECIFICATION

DA2M78BR-Y-天然纯面 1000X1400X12MM	12 MM
DB2M78BR-Y-天然纯面 1600X2000X12MM	12 MM
DB2M78BP-Y-亮光面 1600X2000X12MM	12 MM

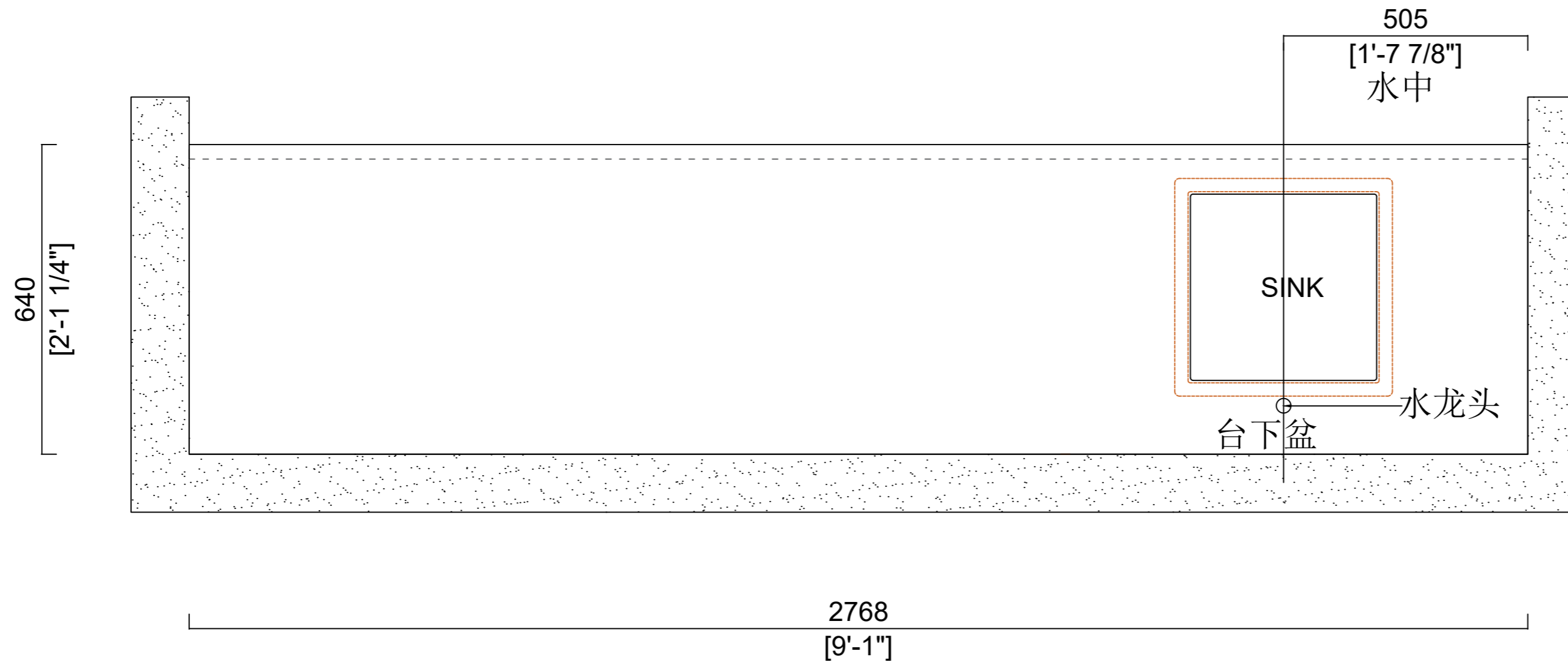

# WAYMOVE

Order No: WMCA240919001

Client Name: Wylie

Email:

Client Address:

Room Space: LAUNDRY

Carcass Material	<input checked="" type="checkbox"/>
Door Material	<input checked="" type="checkbox"/>
Door Shape	<input checked="" type="checkbox"/>

Drawer Handle:

Door Handle:

Remark:

Design Date:

Lead Time: 10-12 Weeks

Consignee:

Date:

Designer:

Tel:

Pages 5

# Krystal's W. I. C

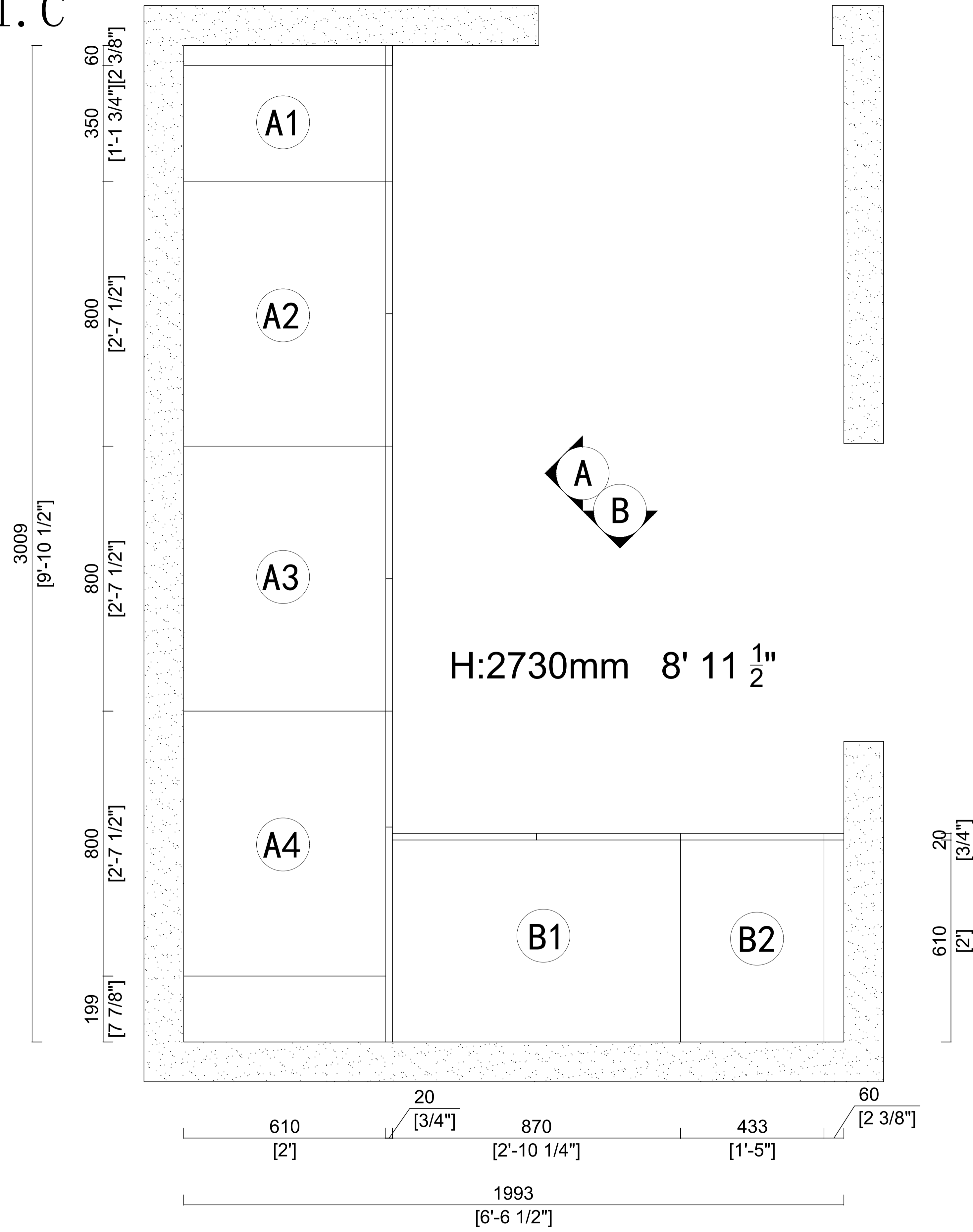

**PLAN**

**WAYMOVE**

Order No: WMCA240919001

Client Name: Wylie

Email:

Client Address:

Room Space: KRISTAL'S  
W.I.C.

Carcass Material	<input checked="" type="checkbox"/>
Door Material	<input checked="" type="checkbox"/>
Door Shape	<input checked="" type="checkbox"/>

Drawer Handle:

Door Handle:

Remark:

Design Date:

Lead Time: 10-12 Weeks

Consignee:

Date:

Designer:

Tel:

Pages 1

# Krystal's W.I.C

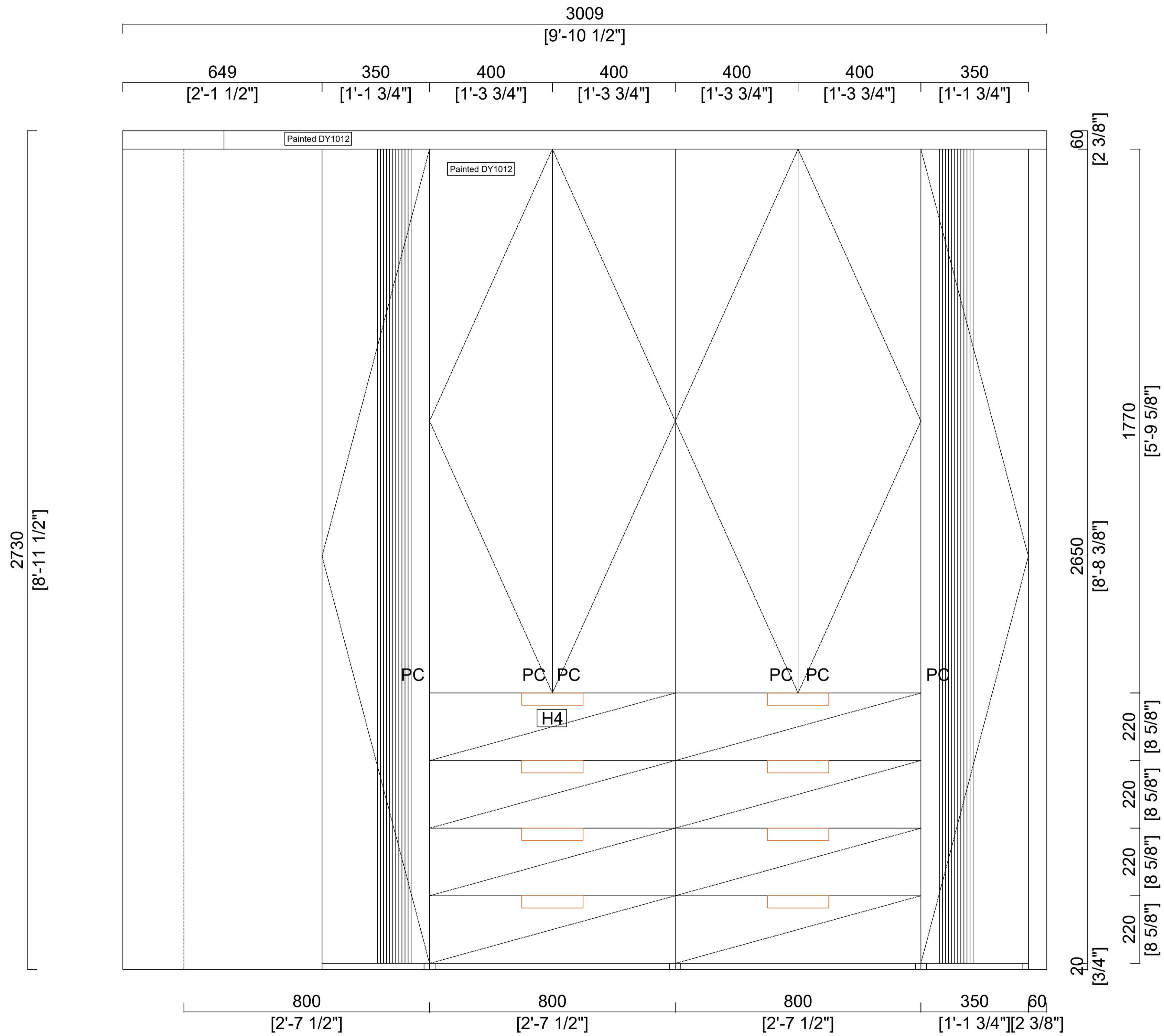

## ELEVATION A

**WAYMOVE**

Order No: WMCA240919001

Client Name: Wylie

Email:

Client Address:

Room Space: KRISTAL'S  
W.I.C.

Carcass Material	<input checked="" type="checkbox"/>
Door Material	<input checked="" type="checkbox"/>
Door Shape	<input checked="" type="checkbox"/>

Drawer Handle:

Door Handle:

Remark:

Design Date:

Lead Time: 10-12 Weeks

Consignee:

Date:

Designer:

Tel:

# Krystal's W.I.C

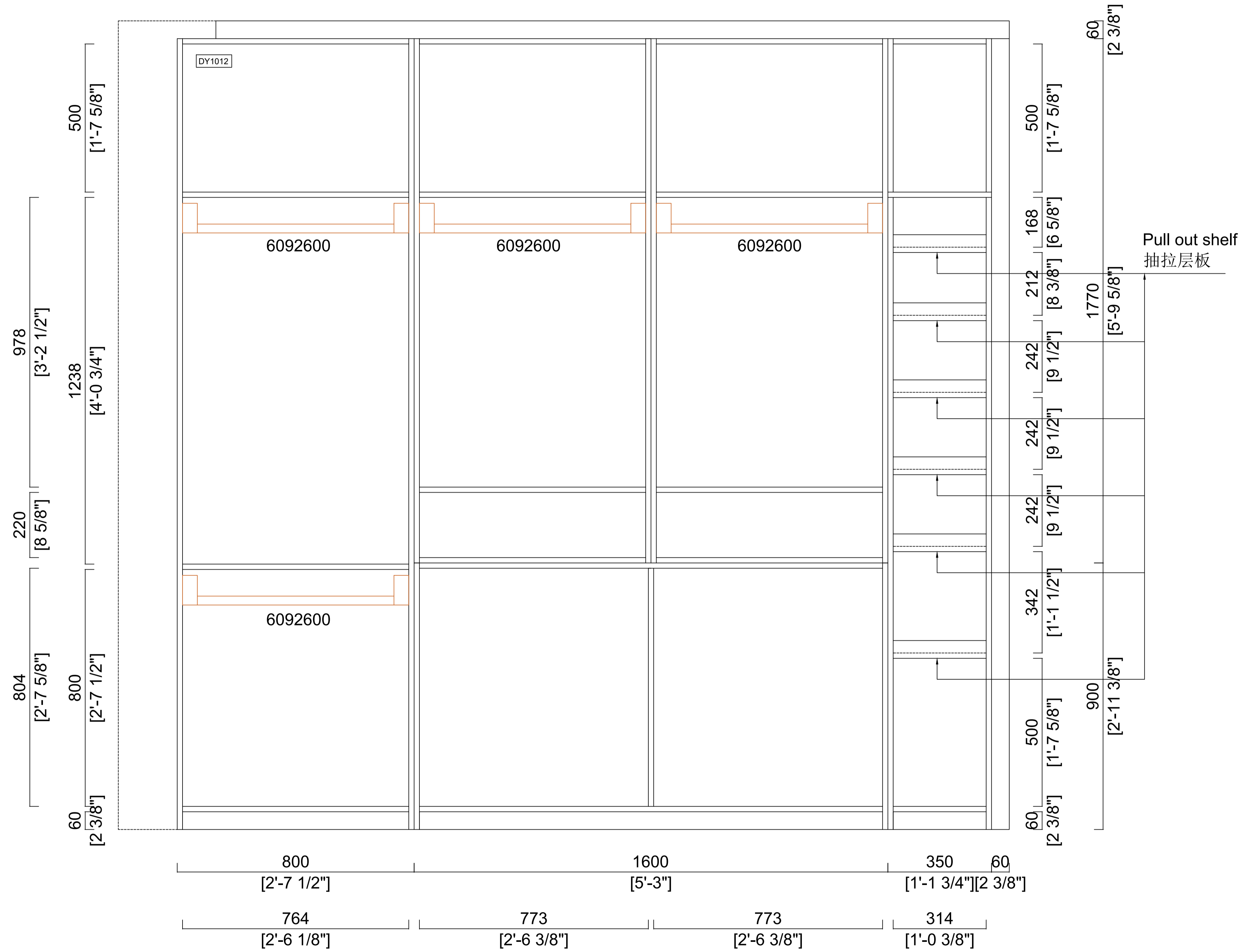

## STRUCTURE A

**WAYMOVE**

Order No: WMCA240919001

Client Name: Wylie

Email:

Client Address:

Room Space: KRISTAL'S  
W.I.C.

Carcass Material	<input checked="" type="checkbox"/>
Door Material	<input type="checkbox"/>
Door Shape	<input checked="" type="checkbox"/>
Drawer Handle:	
Door Handle:	
Remark:	
Design Date:	
Lead Time:	10-12 Weeks
Consignee:	
Date:	
Designer:	
Tel:	

Drawer Handle:

Door Handle:

Remark:

Design Date:

Lead Time: 10-12 Weeks

Consignee:

Date:

Designer:

Tel:

Pages

3

# Krystal's W.I.C

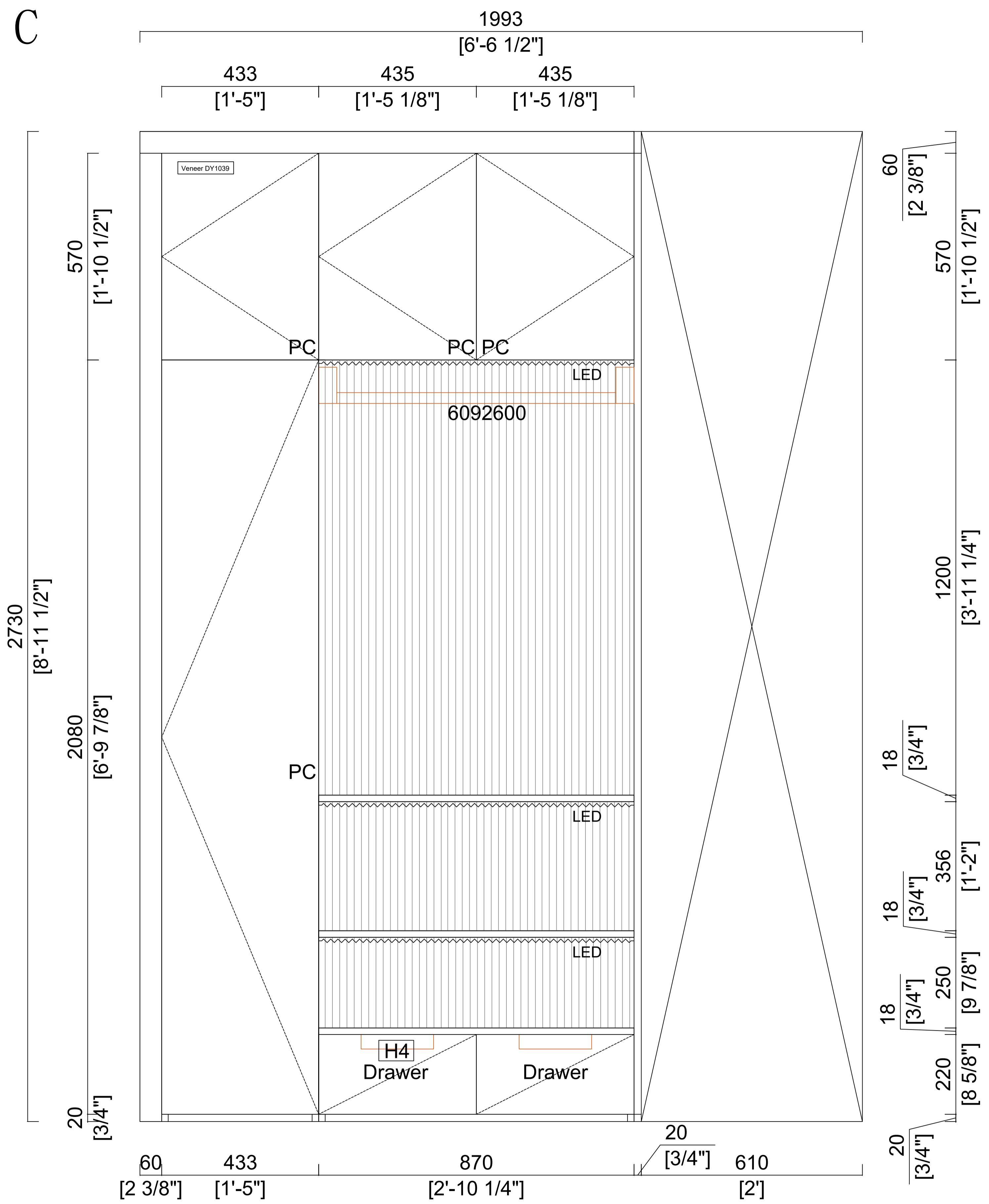

## ELEVATION B



Order No: WMCA240919001

Client Name: Wylie

Email:

Client Address:

Room Space: KRISTAL'S  
W.I.C.

Carcass Material	<input checked="" type="checkbox"/>
Door Material	<input type="checkbox"/>
Door Shape	<input checked="" type="checkbox"/>

Drawer Handle:

Door Handle:

Remark:

Design Date:

Lead Time: 10-12 Weeks

Consignee:  
Date:

Designer:  
Tel:

# Krystal's W. I. C

B-B  
|

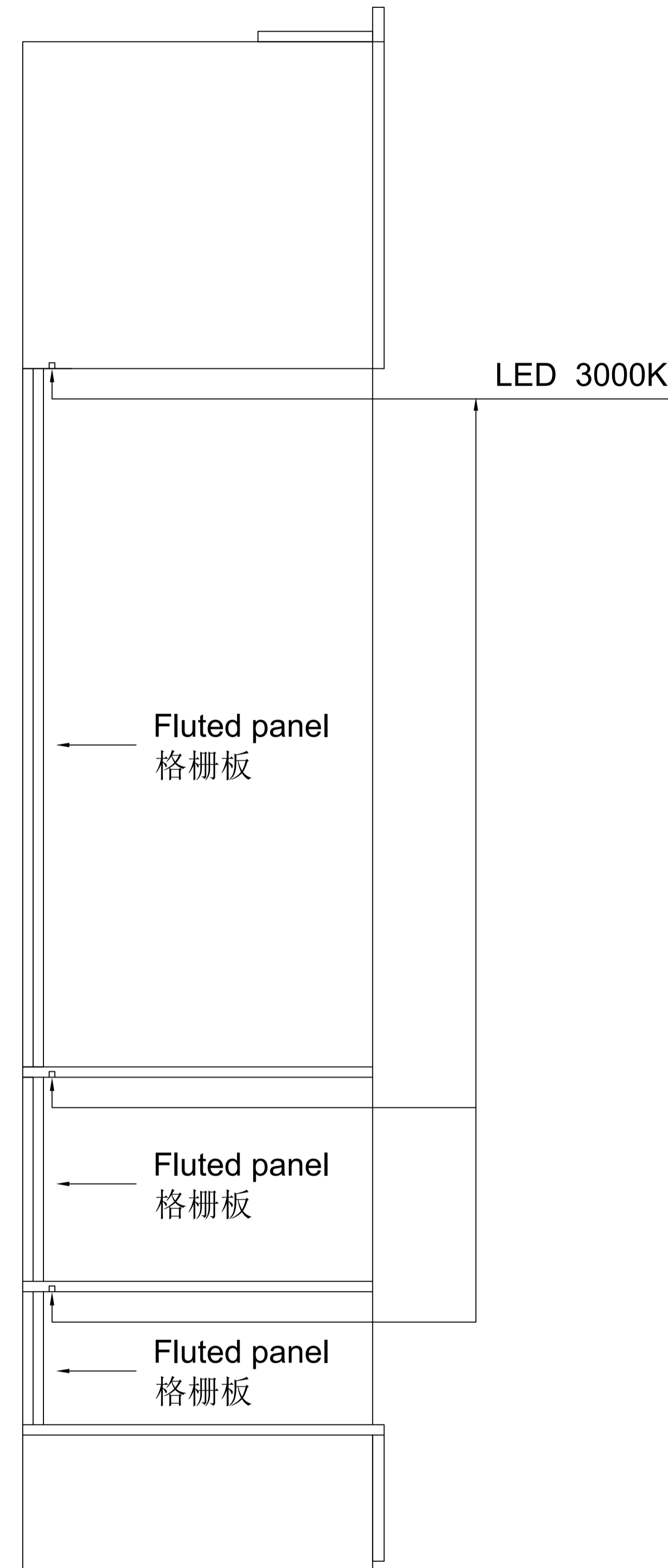
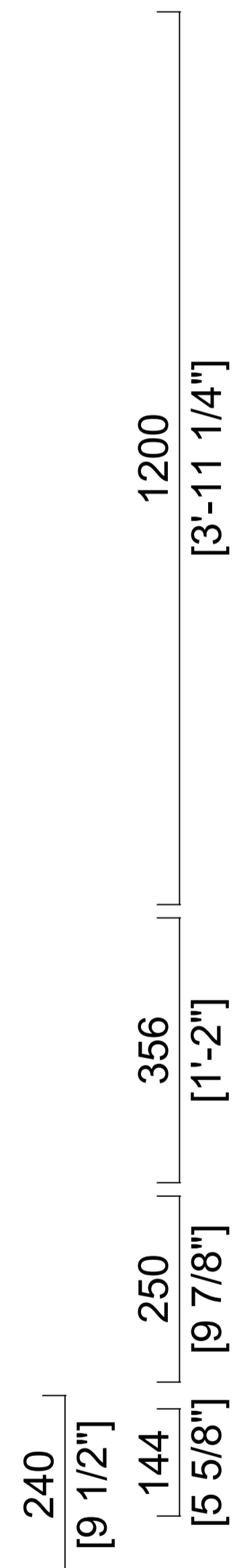
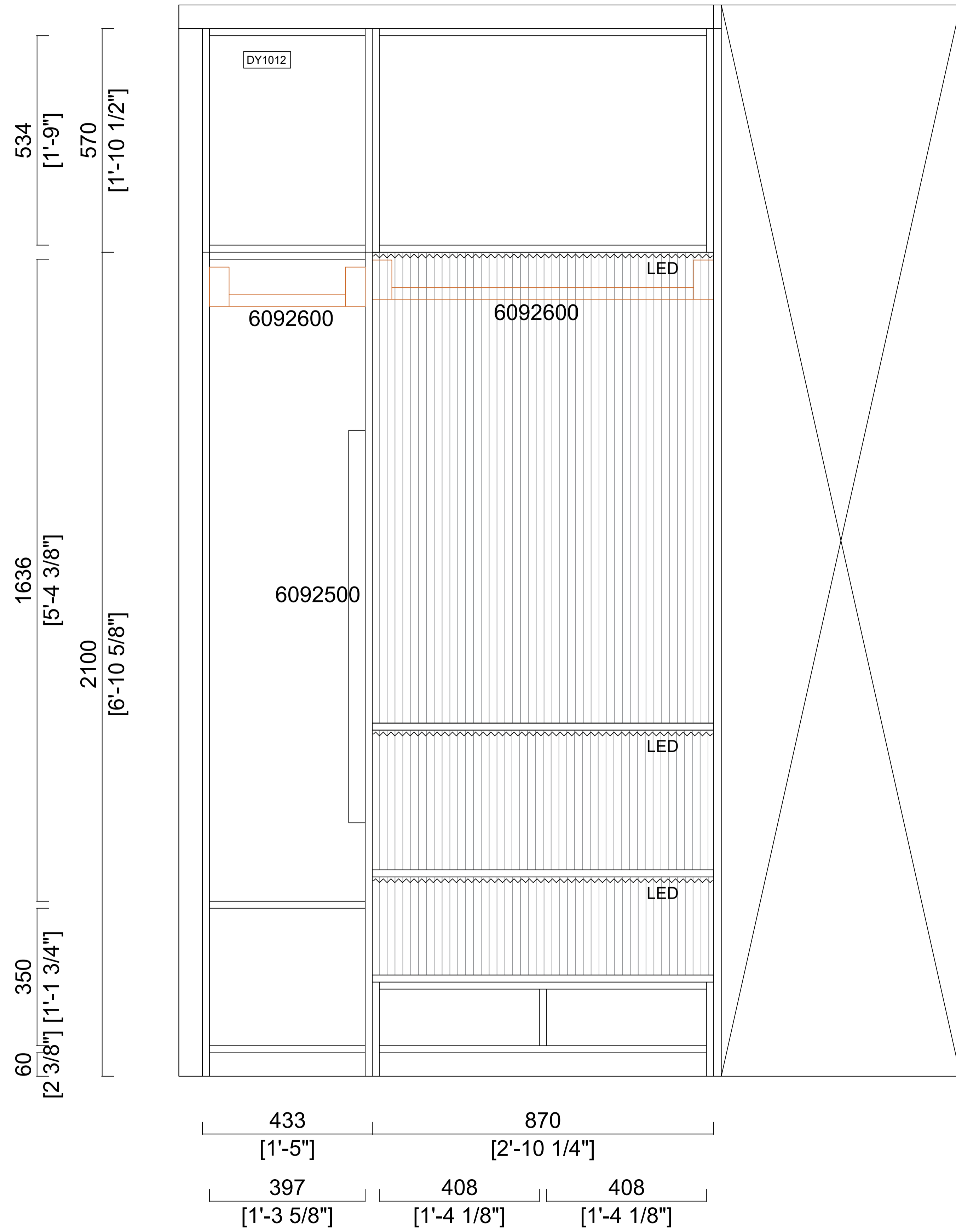

B-B

## STRUCTURE B



Order No: WMCA240919001  
Client Name: Wylie

Email:  
Client Address:

Room Space: KRISTAL'S  
W.I.C.

Carcass Material	<input checked="" type="checkbox"/>
Door Material	<input checked="" type="checkbox"/>
Door Shape	<input checked="" type="checkbox"/>

Drawer Handle:  
Door Handle:  
Remark:

Design Date:  
Lead Time: 10-12 Weeks

Consignee:  
Date:

Designer:  
Tel:

# Wylie's W.I.C

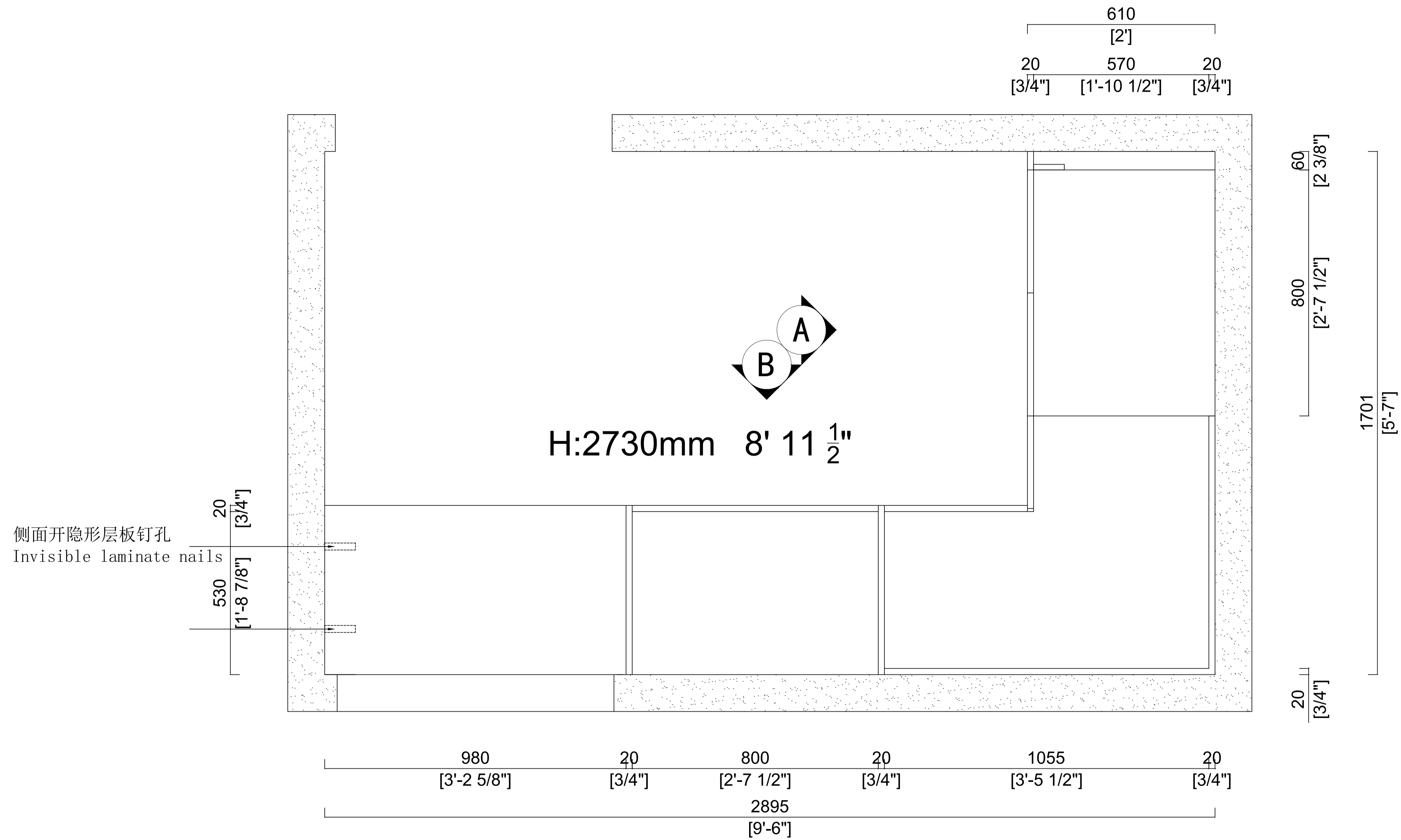

Order No: WMCA240919001

Client Name: Wylie

Email:

Client Address:

Room Space: WYLIE'S  
W.I.C.

Carcass Material	<input checked="" type="checkbox"/>
Door Material	<input type="checkbox"/>
Door Shape	<input checked="" type="checkbox"/>

Drawer Handle:

Door Handle:

Remark:

Design Date:

Lead Time: 10-12 Weeks

Consignee:  
Date:

Designer:  
Tel:

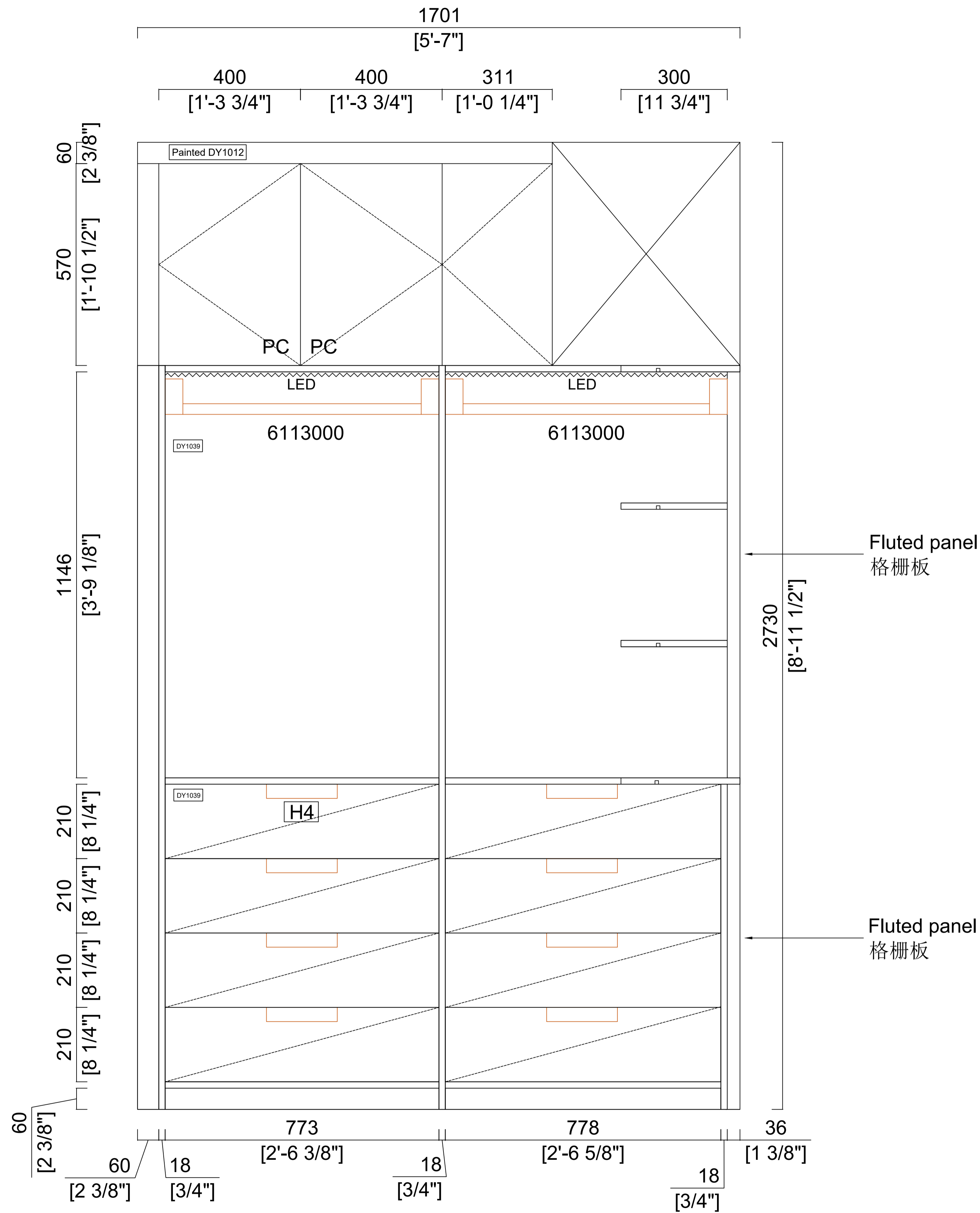

**ELEVATION A**

**WAYMOVE**

Order No: WMCA240919001

Client Name: Wylie

Email:

Client Address:

Room Space: WYLIE'S  
W.I.C.

Carcass Material	
Door Material	
Door Shape	

Drawer Handle:

Door Handle:

Remark:

Design Date:

Lead Time: 10-12 Weeks

Consignee:

Date:

Designer:

Tel:

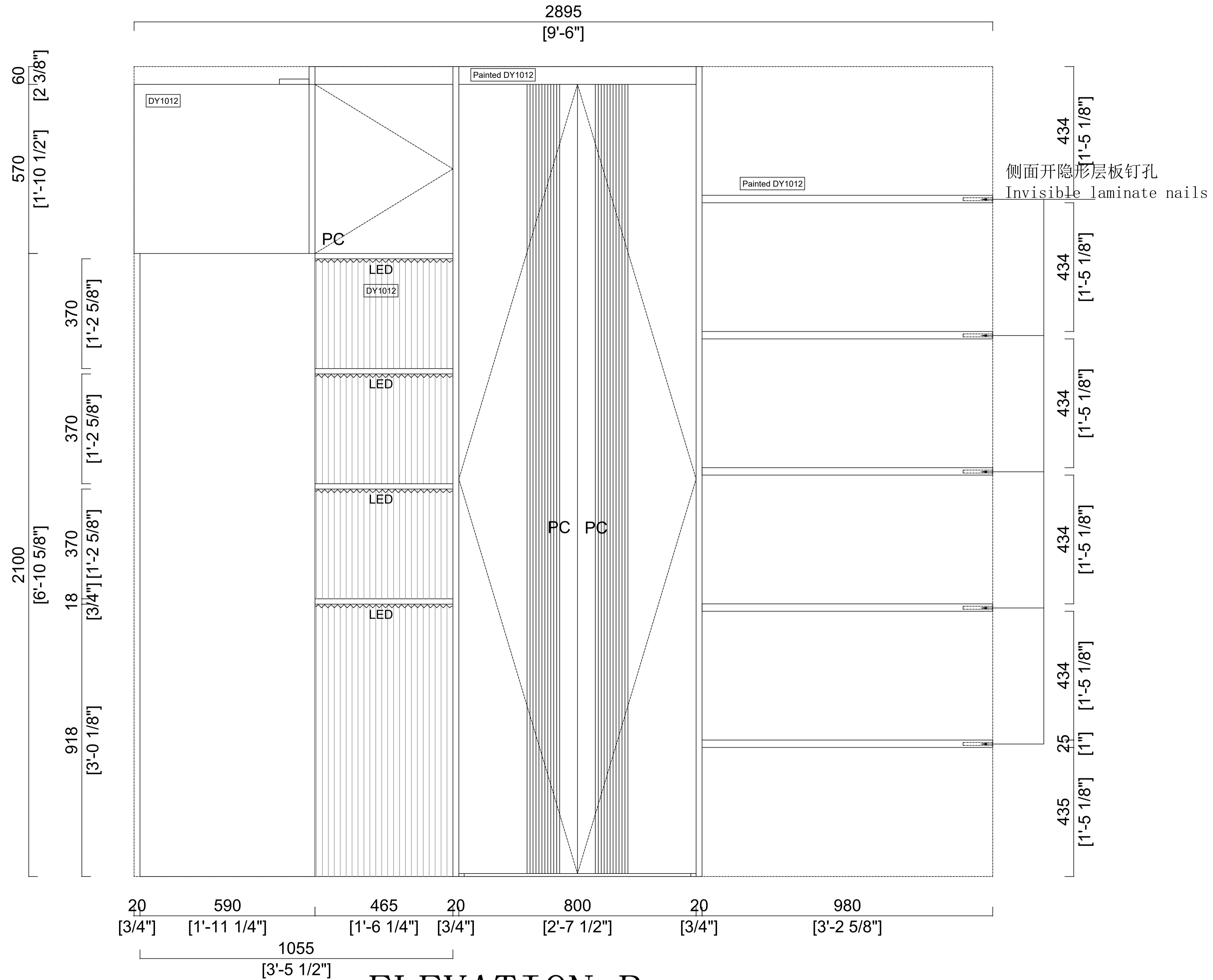

**ELEVATION B**

Order No: WMCA240919001

Client Name: Wylie

Email:

Client Address:

Room Space: WYLIE'S  
W.I.C.

Carcass Material	<input checked="" type="checkbox"/>
Door Material	<input type="checkbox"/>
Door Shape	<input checked="" type="checkbox"/>

Drawer Handle:

Door Handle:

Remark:

Design Date:

Lead Time: 10-12 Weeks

Consignee:

Date:

Designer:

Tel:

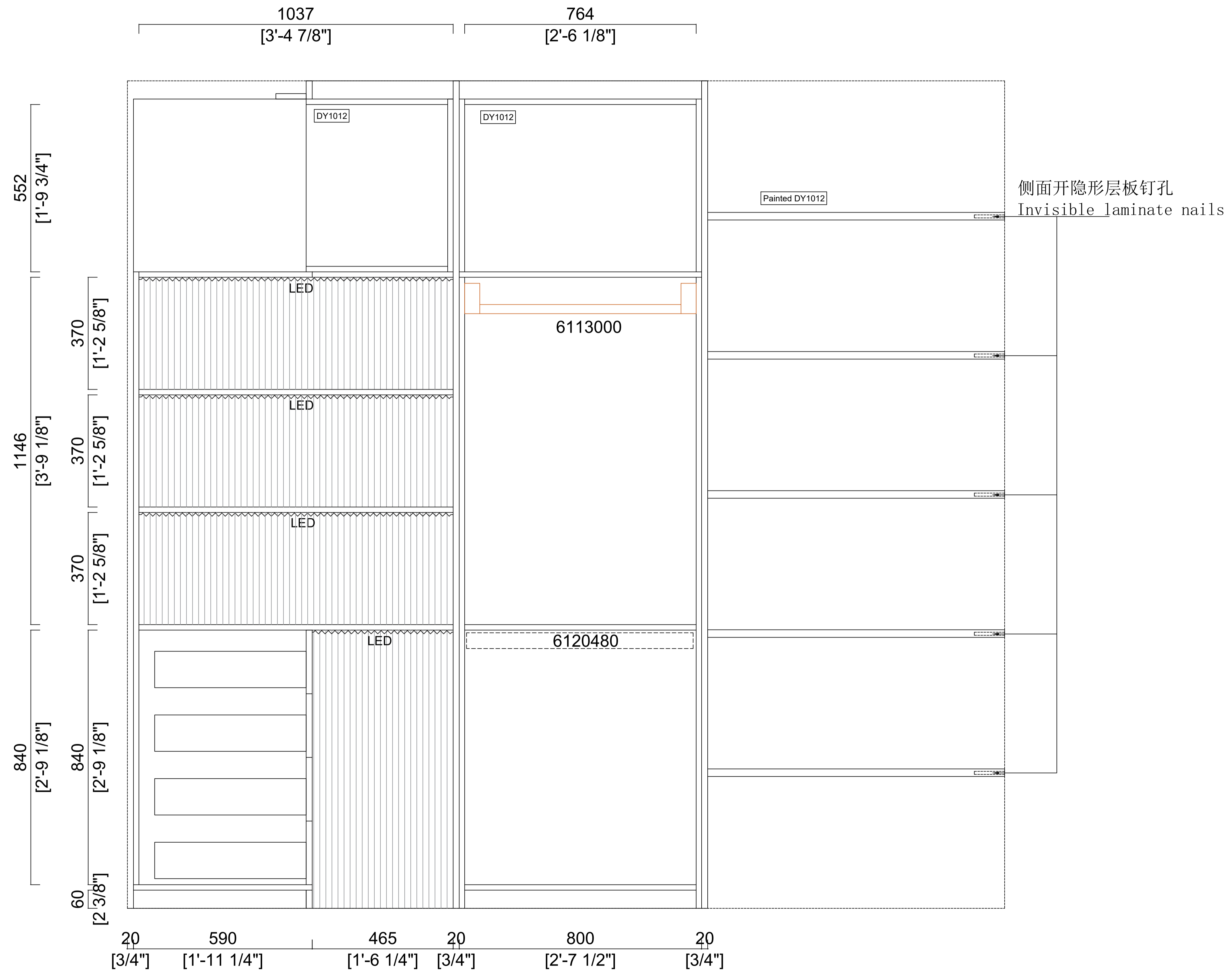

**STRUCTURE B**

**WAYMOVE**

Order No: WMCA240919001

Client Name: Wylie

Email:

Client Address:

Room Space: WYLIE'S  
W.I.C.

Carcass Material	<input checked="" type="checkbox"/>
Door Material	<input type="checkbox"/>
Door Shape	<input checked="" type="checkbox"/>

Drawer Handle:

Door Handle:

Remark:

Design Date:

Lead Time: 10-12 Weeks

Consignee:

Date:

Designer:

Tel:

Pages 4

# Vanity 1

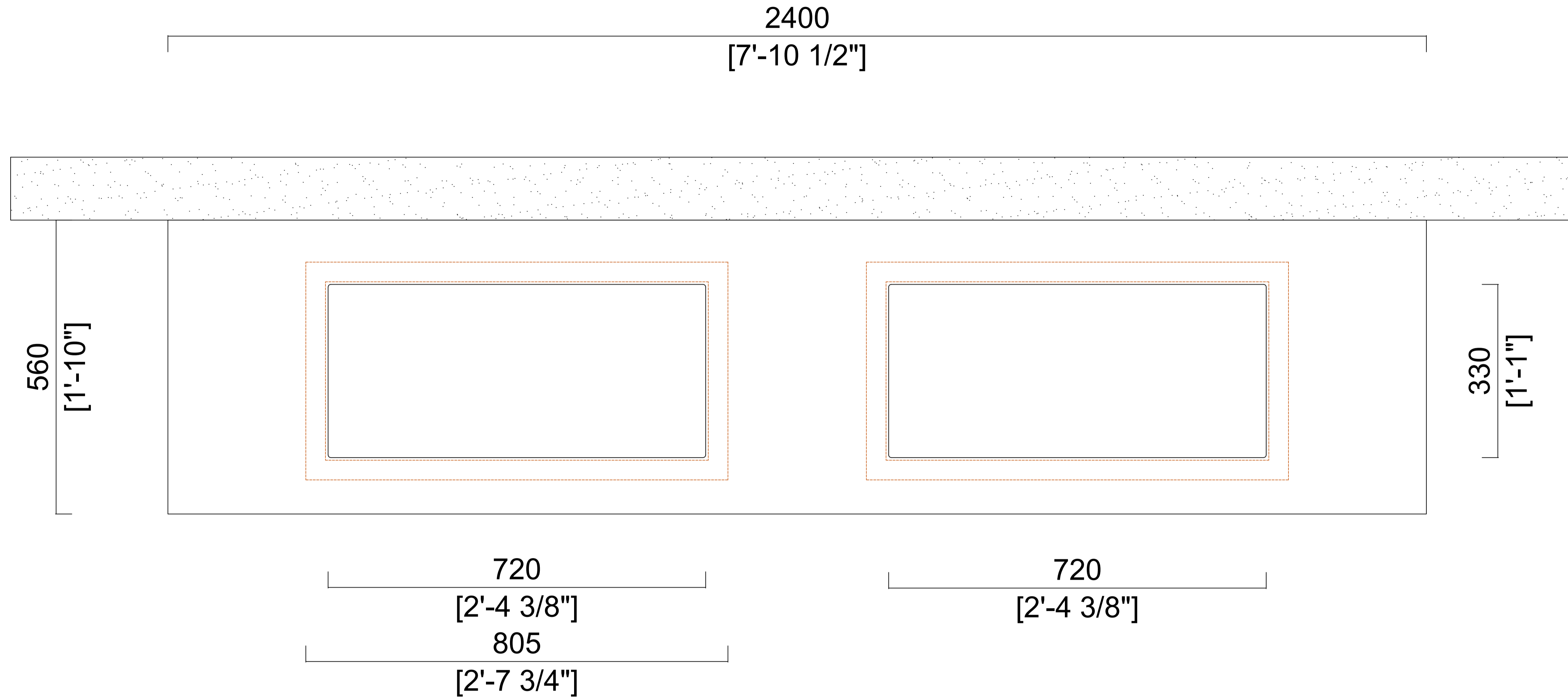

## PLAN

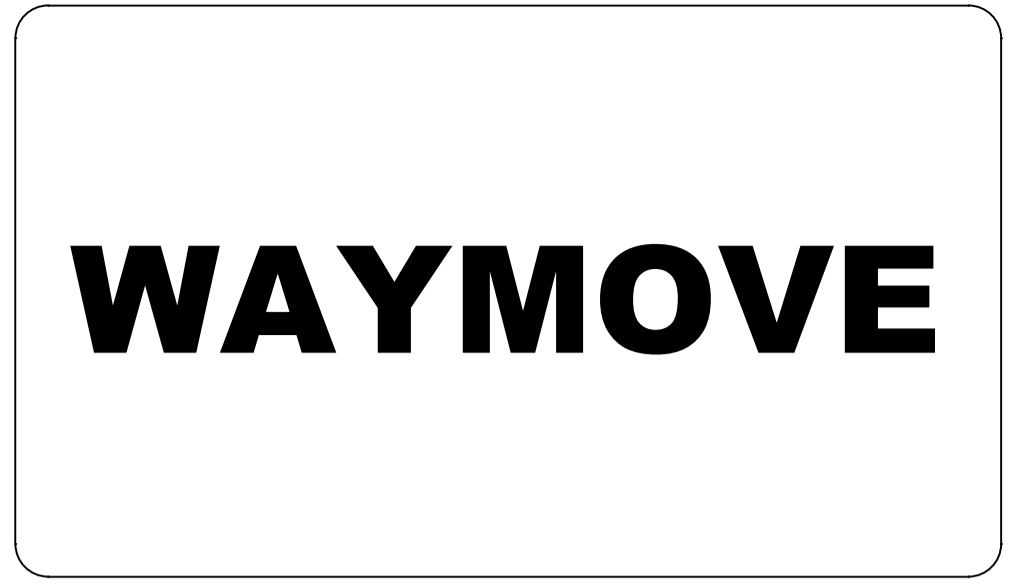

Order No: WMCA240919001

Client Name: Wylie

Email:

Client Address:

Room Space: VANITY 1

Carcass Material	<input checked="" type="checkbox"/>
Door Material	<input checked="" type="checkbox"/>
Door Shape	<input checked="" type="checkbox"/>

Drawer Handle:

Door Handle:

Remark:

Design Date:

Lead Time: 10-12 Weeks

Consignee:  
Date:

Designer:  
Tel:

# Vanity 1

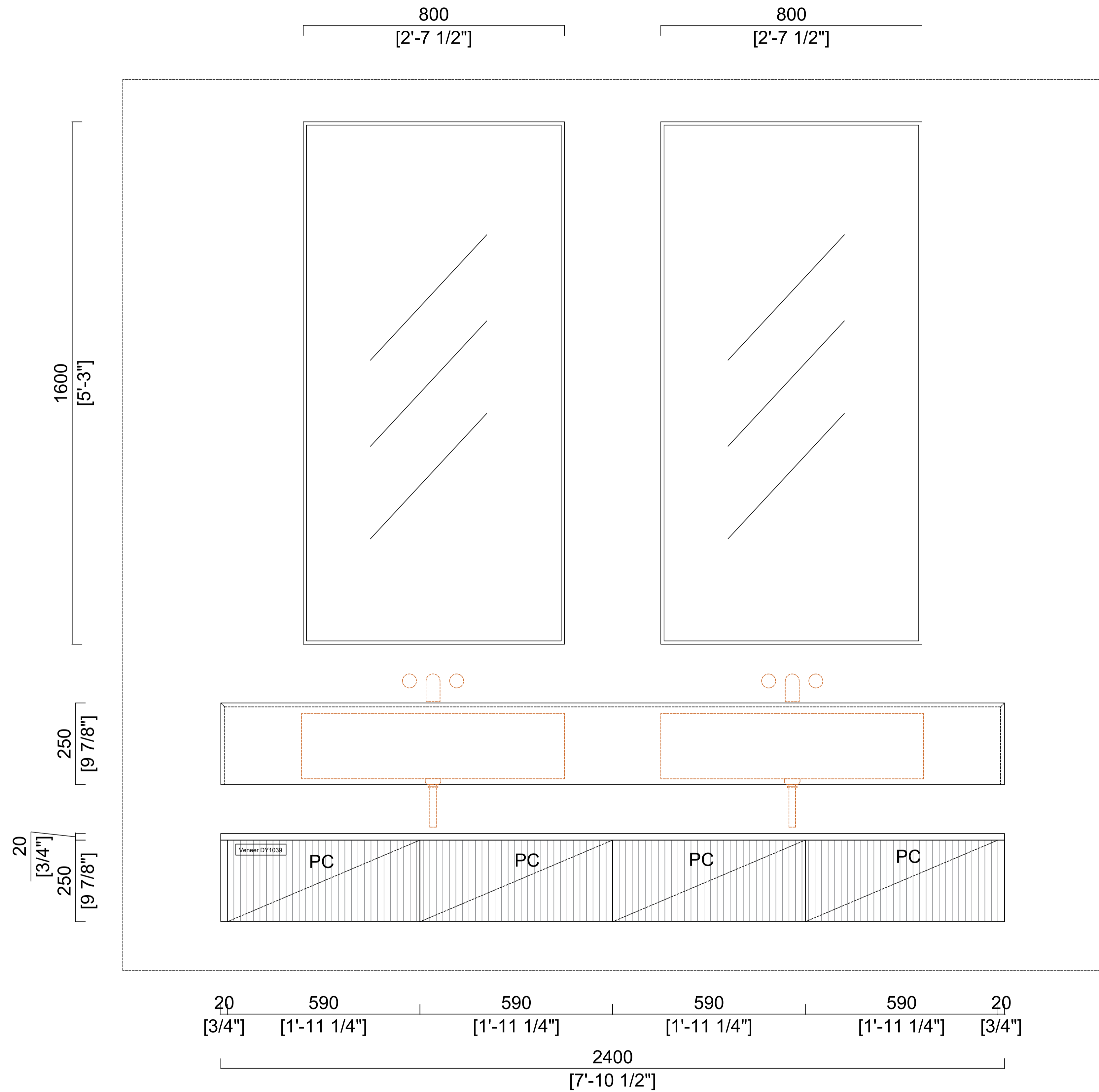

## ELEVATION

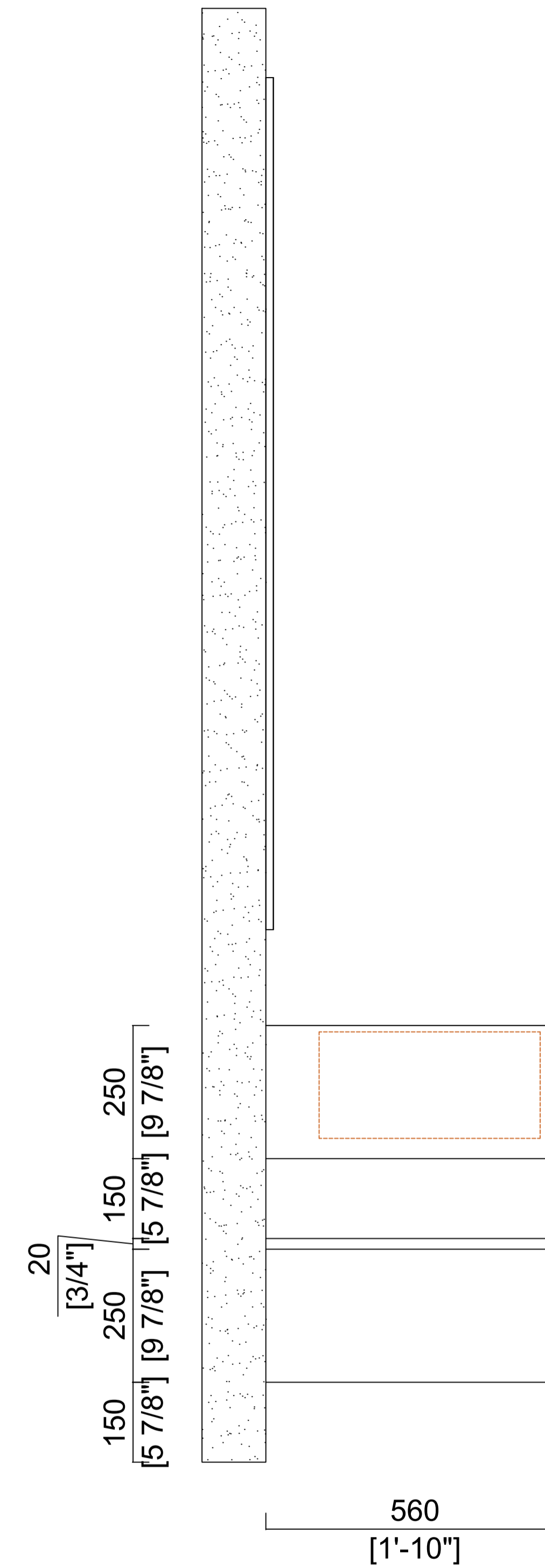

**WAYMOVE**

Order No: WMCA240919001

Client Name: Wylie

Email:

Client Address:

Room Space: VANITY 1

Carcass Material	<input checked="" type="checkbox"/>
Door Material	<input type="checkbox"/>
Door Shape	<input checked="" type="checkbox"/>

Drawer Handle:

Door Handle:

Remark:

Design Date:

Lead Time: 10-12 Weeks

Consignee:

Date:

Designer:

Tel:

# Vanity 1



81cm大尺寸弧底(6070)单盆配陶瓷下水

外径: 805x415x200mm

内径: 730x340x150mm



带提篮防堵下水器



防臭下水管

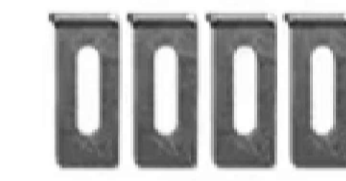

台下盆固定螺丝套装

## WAYMOVE

Order No: WMCA240919001

Client Name: Wylie

Email:

Client Address:

Room Space: VANITY 1

Carcass  
Material



Door  
Material

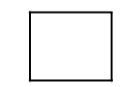

Door  
Shape

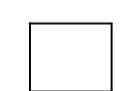
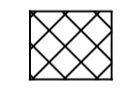

Drawer Handle:

Door Handle:

Remark:

Design Date:

Lead Time: 10-12 Weeks

Consignee:

Date:

Designer:

Tel:

Pages

3

# Vanity 1

水槽

外形尺寸: 805\*415\*200

开孔尺寸: 730\*340\*150

台下盆

台面型号: 圣勃朗鱼肚白12mm

岛台下挂250mm

## CALAEATTA 圣勃朗鱼肚白

### DESCRIPTION

踏上五洲的脚步, 凝望海洋的辽阔, 纵横交错, 犹如不同的人  
生轨迹, 曲折坎坷, 艰难之问, 都化作一段美妙的旅程。  
As if stepping on the Vaporetto, we gaze at the crisscrossing glaciers. Like  
different life trajectories, in full of twists or success. Between advance and  
retreat, they all turn into a wonderful journey.

### SPECIFICATION

DA2M7888Y-天然纯面 300X300X12MM	12 MM
DB2M7888Y-天然纯面 300X300X12MM	12 MM
DB2M7888Y-亮光面 300X300X12MM	12 MM

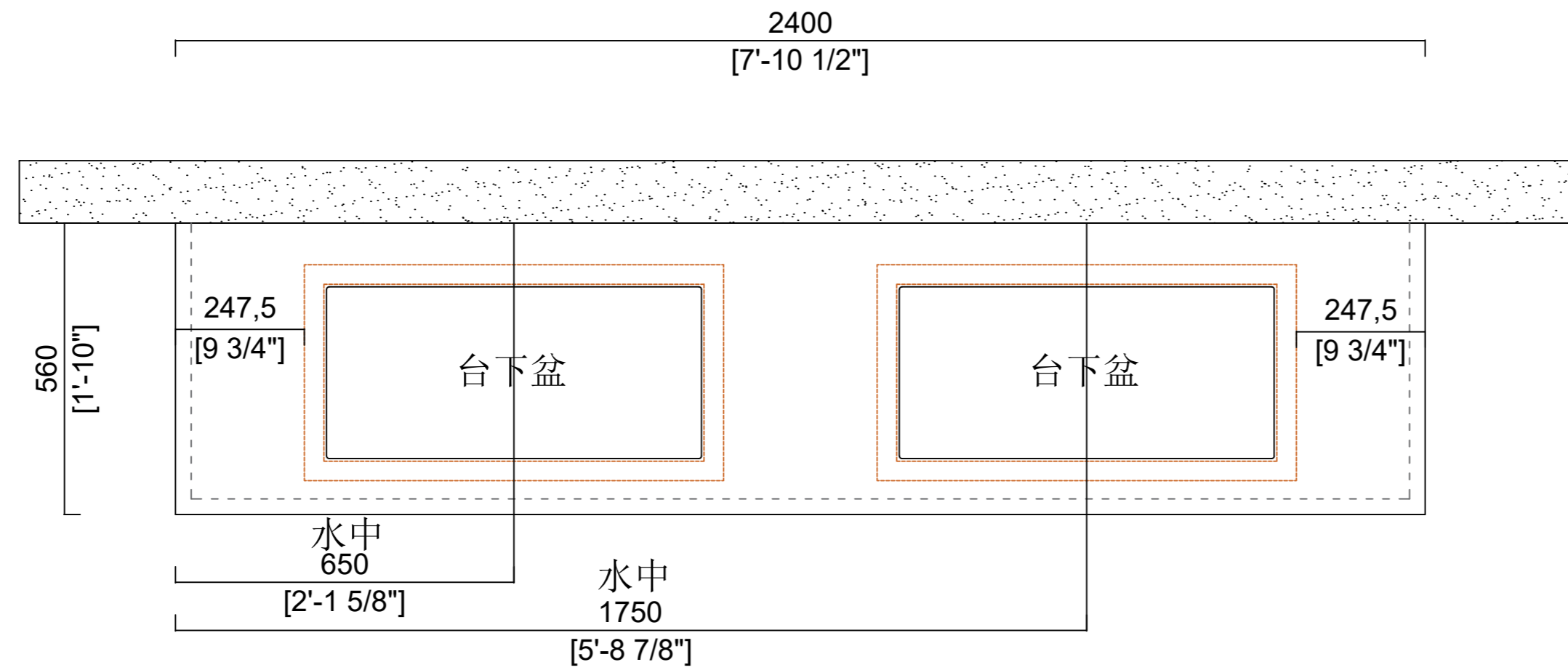

PLAN

# WAYMOVE

Order No: WMCA240919001

Client Name: Wylie

Email:

Client Address:

Room Space: VANITY 1

Carcass Material	
Door Material	
Door Shape	

Drawer Handle:

Door Handle:

Remark:

Design Date:

Lead Time: 10-12 Weeks

Consignee:

Date:

Designer:

Tel:

Pages 4

# Vanity 2

开隐形层板钉孔  
Invisible laminate nails

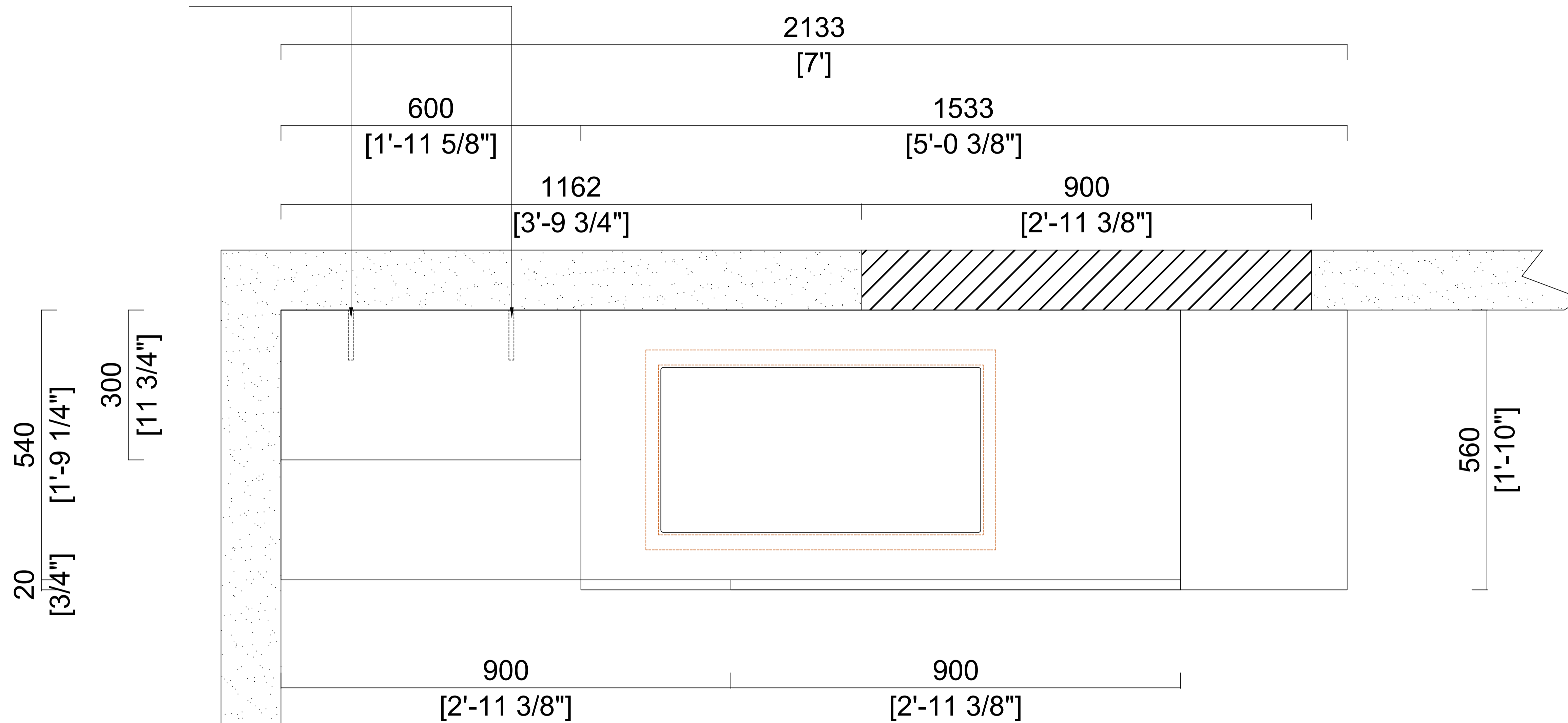

## PLAN



Order No: WMCA240919001	
Client Name: Wylie	
Email:	
Client Address:	
Room Space: VANITY 2	
Carcass Material	<input checked="" type="checkbox"/>
Door Material	<input type="checkbox"/>
Door Shape	<input checked="" type="checkbox"/>
Drawer Handle:	
Door Handle:	
Remark:	
Design Date:	
Lead Time: 10-12 Weeks	
Consignee:	
Date:	
Designer:	
Tel:	
Pages	1

# Vanity 2

**WAYMOVE**

Order No: WMCA240919001

Client Name: Wylie

Email:

Client Address:

Room Space: VANITY 2

Carcass Material	<input checked="" type="checkbox"/>
Door Material	<input type="checkbox"/>
Door Shape	<input checked="" type="checkbox"/>
	<input type="checkbox"/>

Drawer Handle:

Door Handle:

Remark:

Design Date:

Lead Time: 10-12 Weeks

Consignee:

Date:

Designer:

Tel:

Pages 2

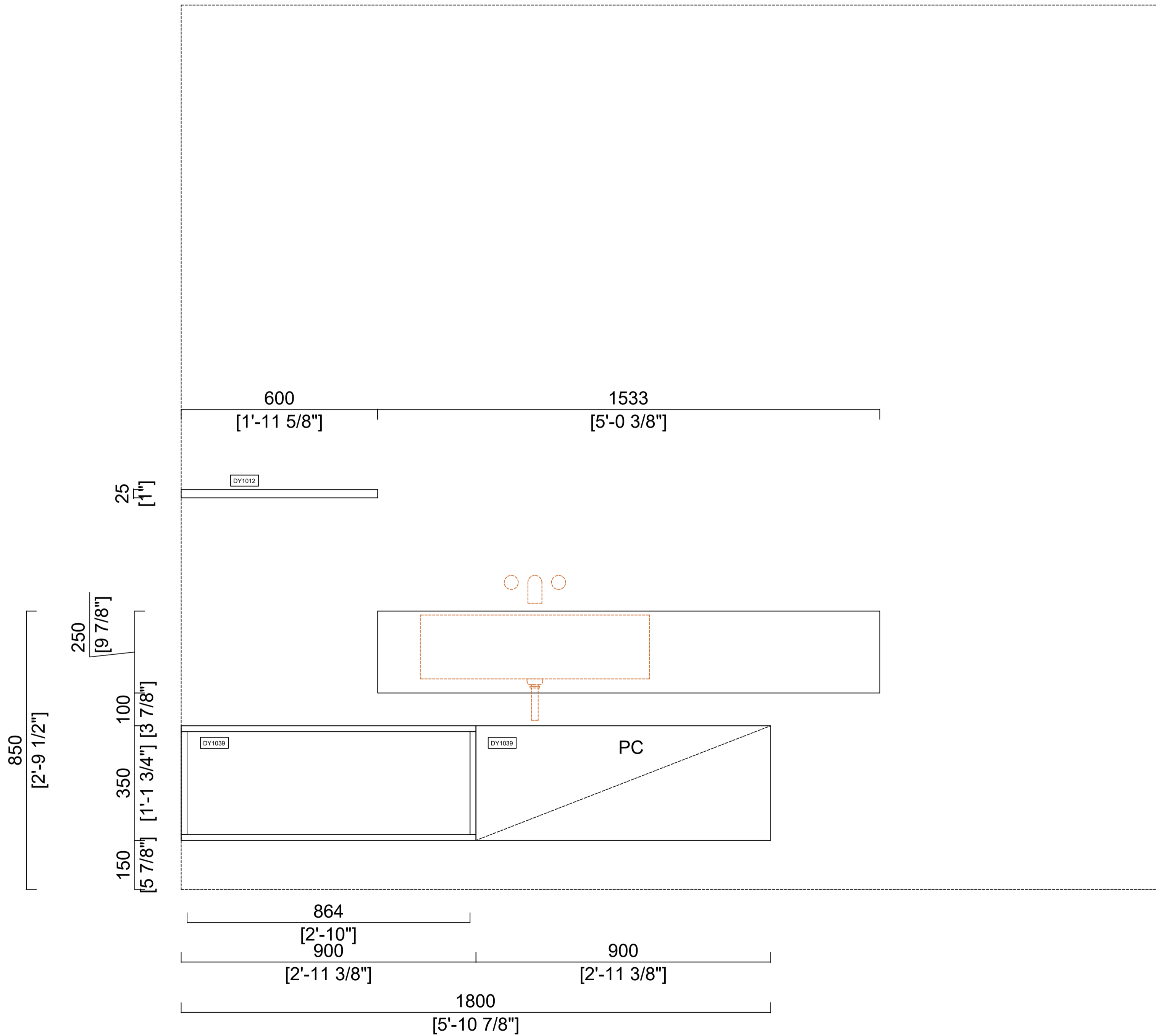

**ELEVATION**

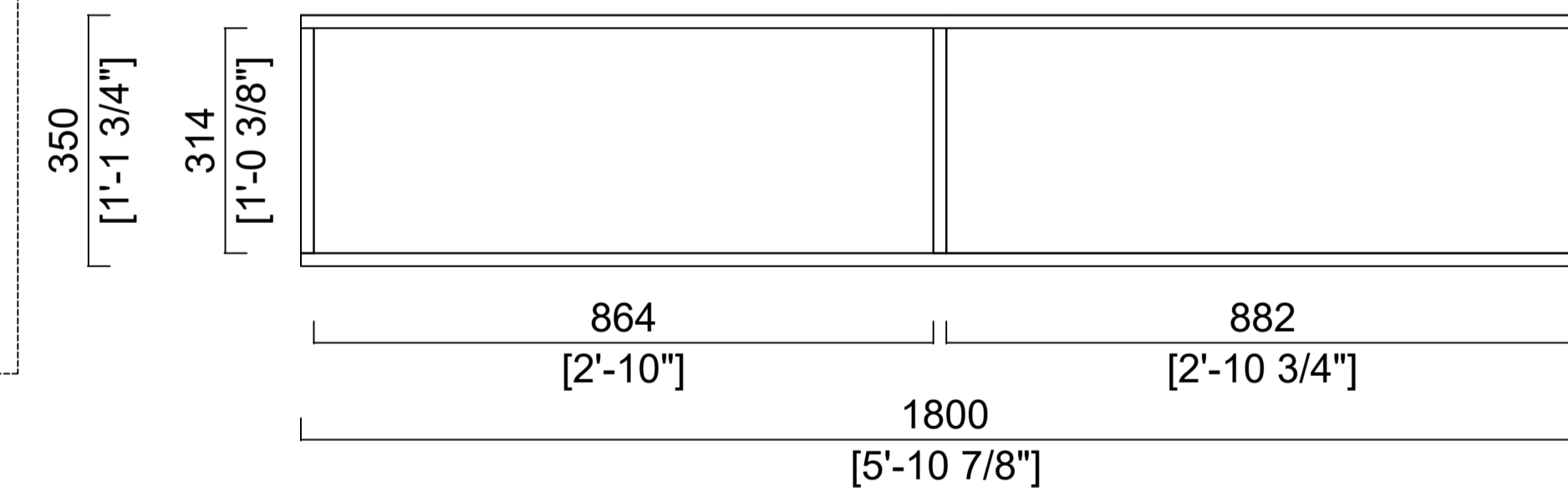

# Vanity 2



● 平底方盆 外径: 700X400X195mm  
28寸 内径: 650X340X150mm

**WAYMOVE**

Order No: WMCA240919001

Client Name: Wylie

Email:

Client Address:

Room Space: VANITY 2

Carcass  
Material

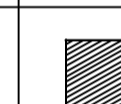

Door  
Material

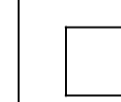

Door  
Shape

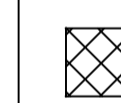

Drawer Handle:

Door Handle:

Remark:

Design Date:

Lead Time: 10-12 Weeks

Consignee:

Date:

Designer:

Tel:

Pages

3

# Vanity 2

水槽

外形尺寸: 700\*400\*195

开孔尺寸: 650\*340\*150

台下盆

台面型号:

岛台下挂250mm

## BOSNIA GREY

波西尼亚灰

### DESCRIPTION

丰富又深邃的银白纹理划过一抹深沉的灰, 恰似碧海金沙的自然风光, 展露着平实又壮丽的美。  
The rich and deep silver-white texture crossed a deep gray. Just like the harmonious and quiet natural scenery, it reveals the immortal and magnificent beauty.

### SPECIFICATION

DA2M64BK-Y-晶理面 12MM

DB2M64BR-Y-天鹅绒面 12MM

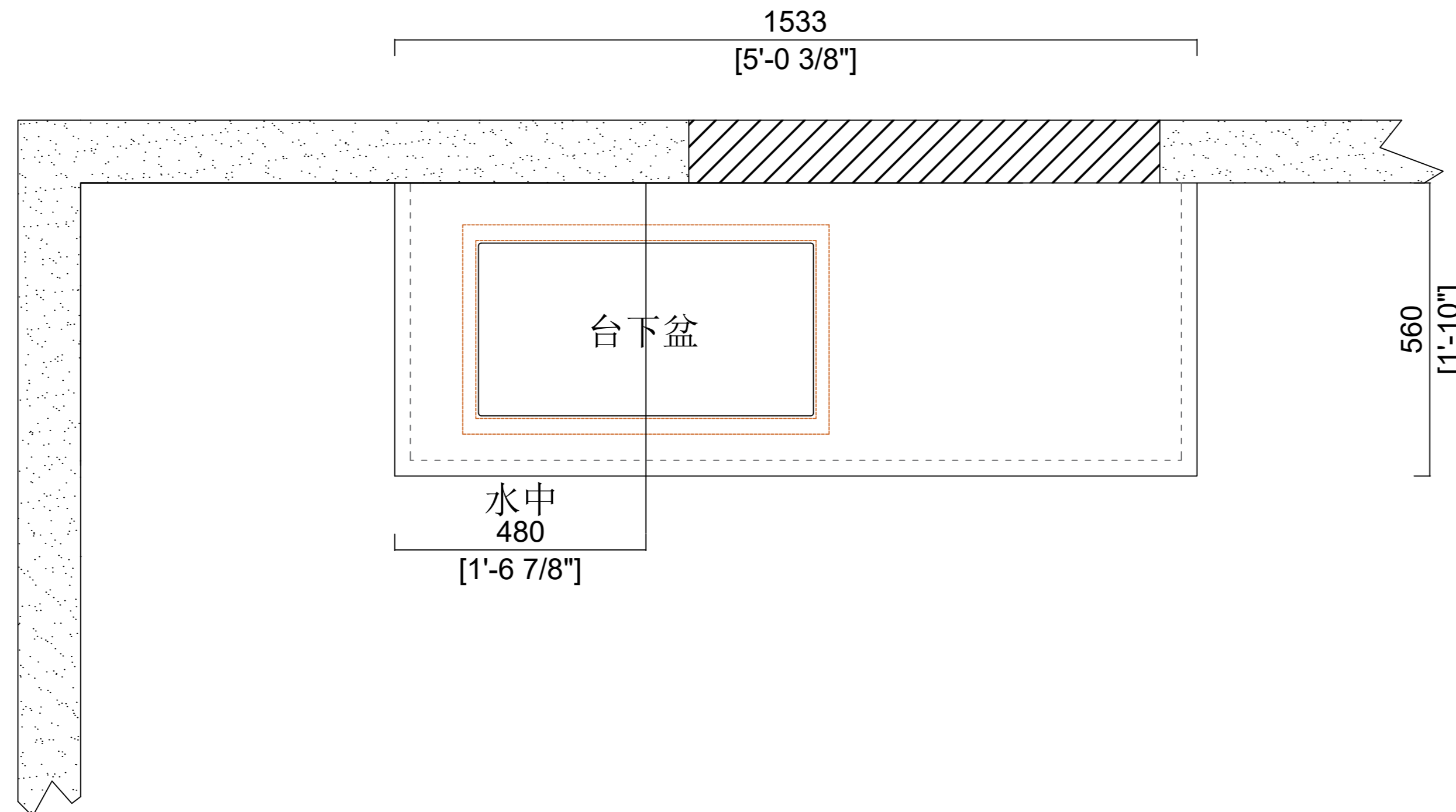

# WAYMOVE

Order No: WMCA240919001

Client Name: Wylie

Email:

Client Address:

Room Space: VANITY 2

Carcass  
Material



Door



Material



Door



Shape



Drawer Handle:

Door Handle:

Remark:

Design Date:

Lead Time: 10-12 Weeks

Consignee:

Date:

Designer:

Tel:

Pages

4

# Vanity 3

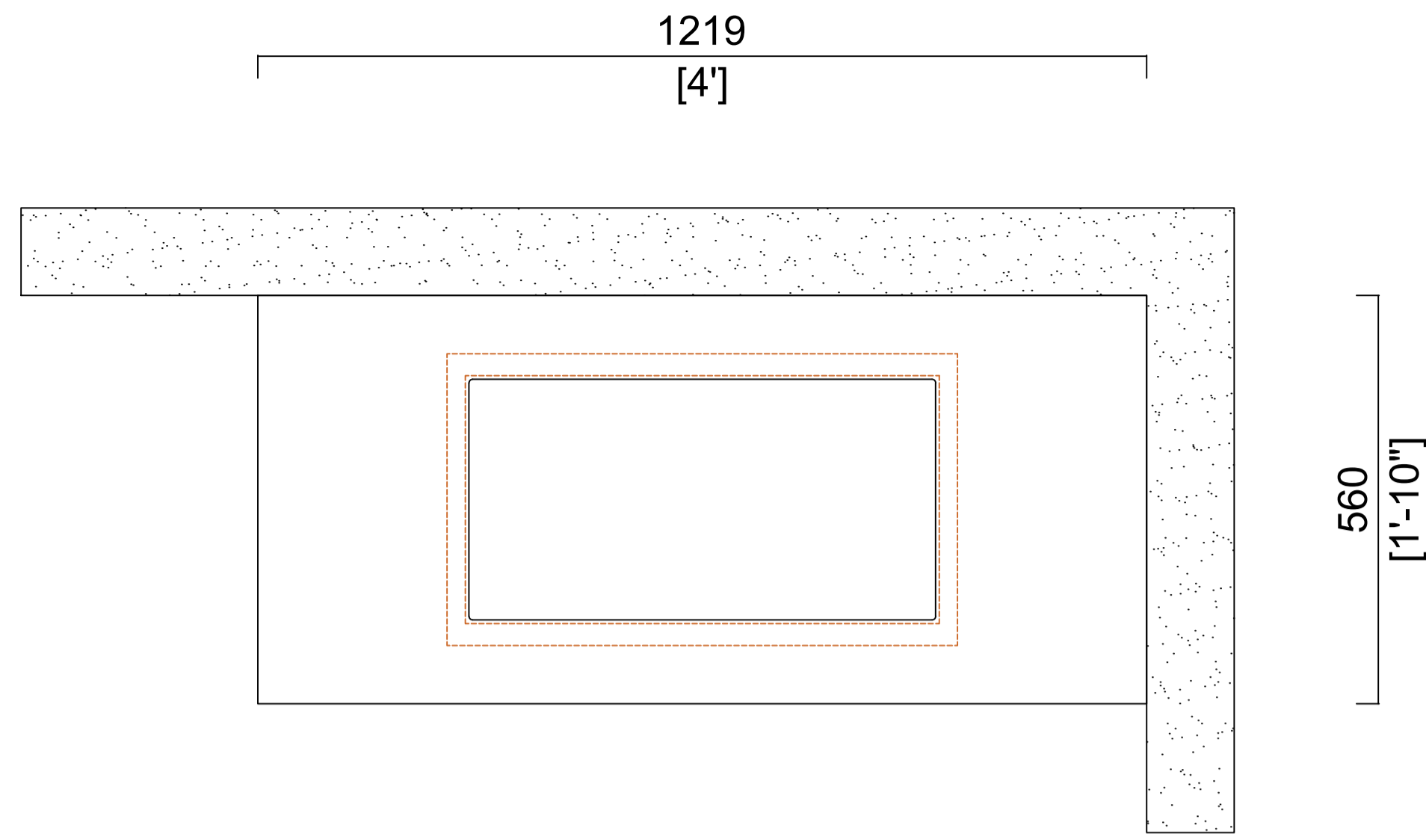

**PLAN**

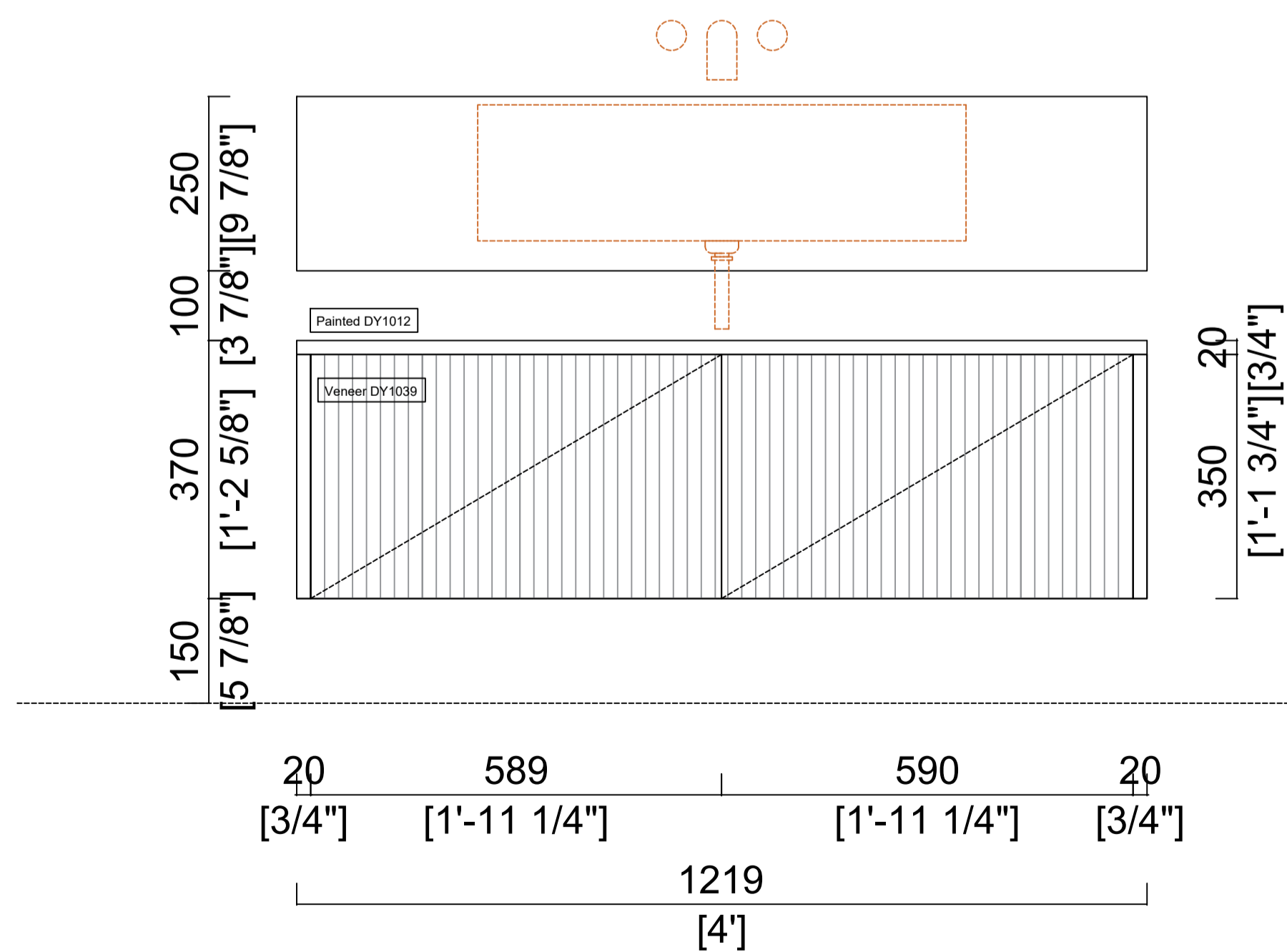
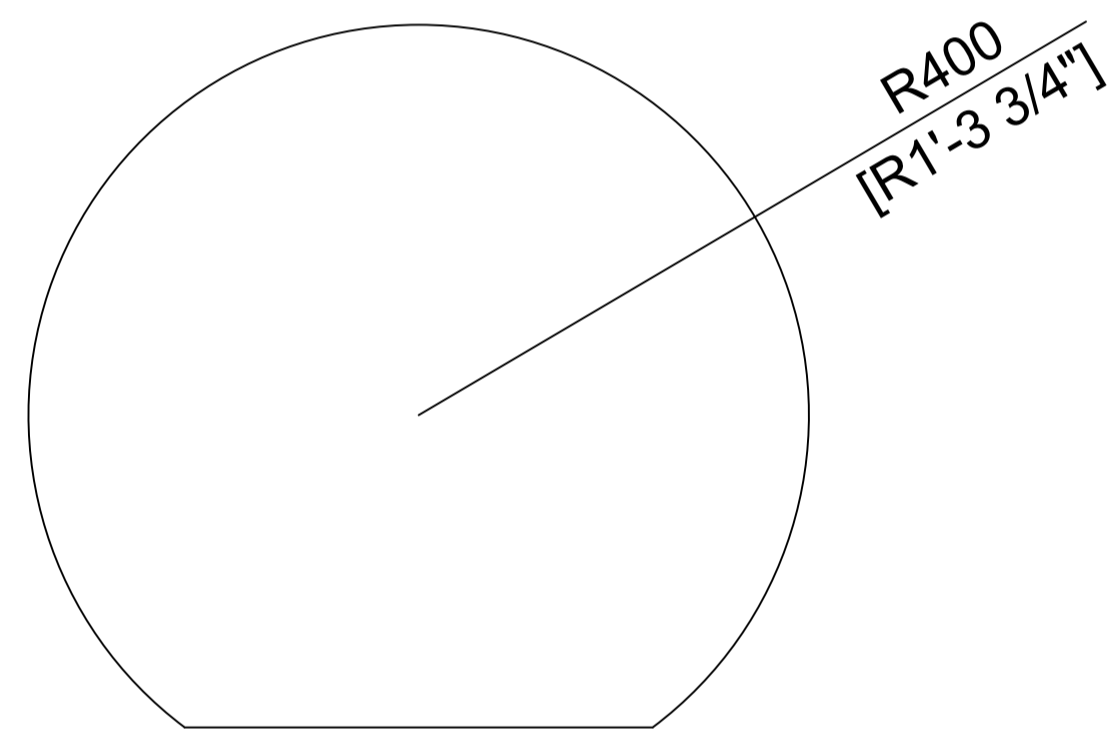

**ELEVATION**

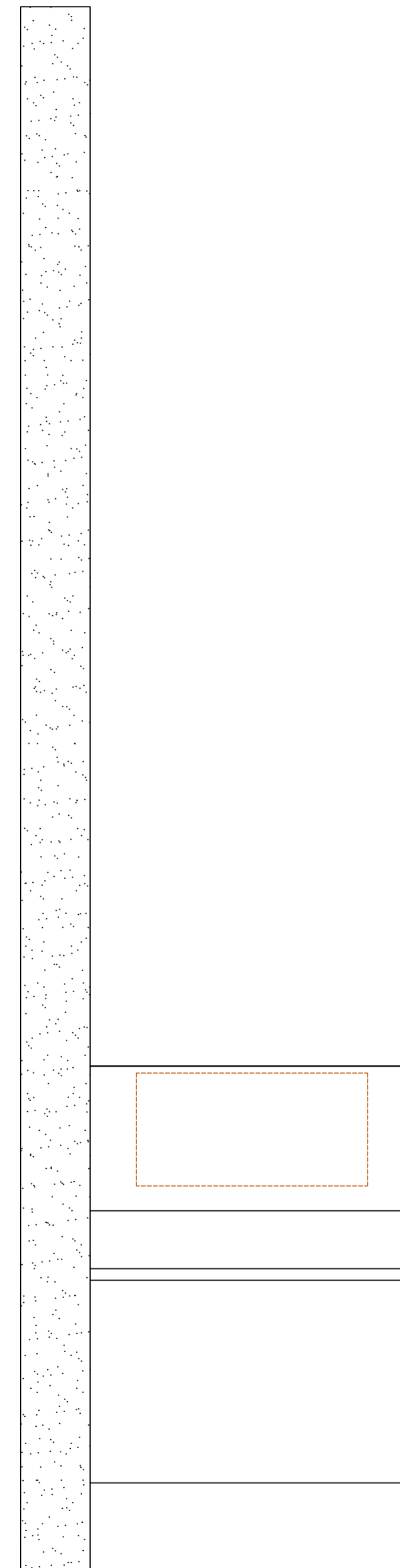

**WAYMOVE**

Order No: WMCA240919001

Client Name: Wylie

Email:

Client Address:

Room Space: VANITY 3

Carcass Material	
Door Material	
Door Shape	

Drawer Handle:

Door Handle:

Remark:

Design Date:

Lead Time: 10-12 Weeks

Consignee:

Date:

Designer:

Tel:

# Vanity 3



• 平底方盆 外径: 700X400X195mm  
28寸 内径: 650X340X150mm

**WAYMOVE**

Order No: WMCA240919001

Client Name: Wylie

Email:

Client Address:

Room Space: VANITY 3

Carcass  
Material



Door  
Material

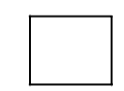

Door  
Shape

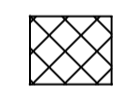

Drawer Handle:

Door Handle:

Remark:

Design Date:

Lead Time: 10-12 Weeks

Consignee:

Date:

Designer:

Tel:

Pages

2

# Vanity 3

水槽

外形尺寸: 700\*400\*195

开孔尺寸: 650\*340\*150

台下盆

台面型号:

岛台下挂250mm

## BOSNIA GREY

波西尼亚灰

### DESCRIPTION

丰富又深邃的岩石纹理经过一抹深沉的灰, 恰似浩瀚黄沙的自然风光, 既质朴又文艺且耐看。  
The rich and deep silver-white texture crossed a deep grey. Just like the far horizon and vast natural scenery, it reveals the unusual and magnificent beauty.

### SPECIFICATION

DAZM648R-Y-细理面 1000X3400X25MM	12MM
DBZM648R-Y-大颗粒面 1000X3200X25MM	12MM

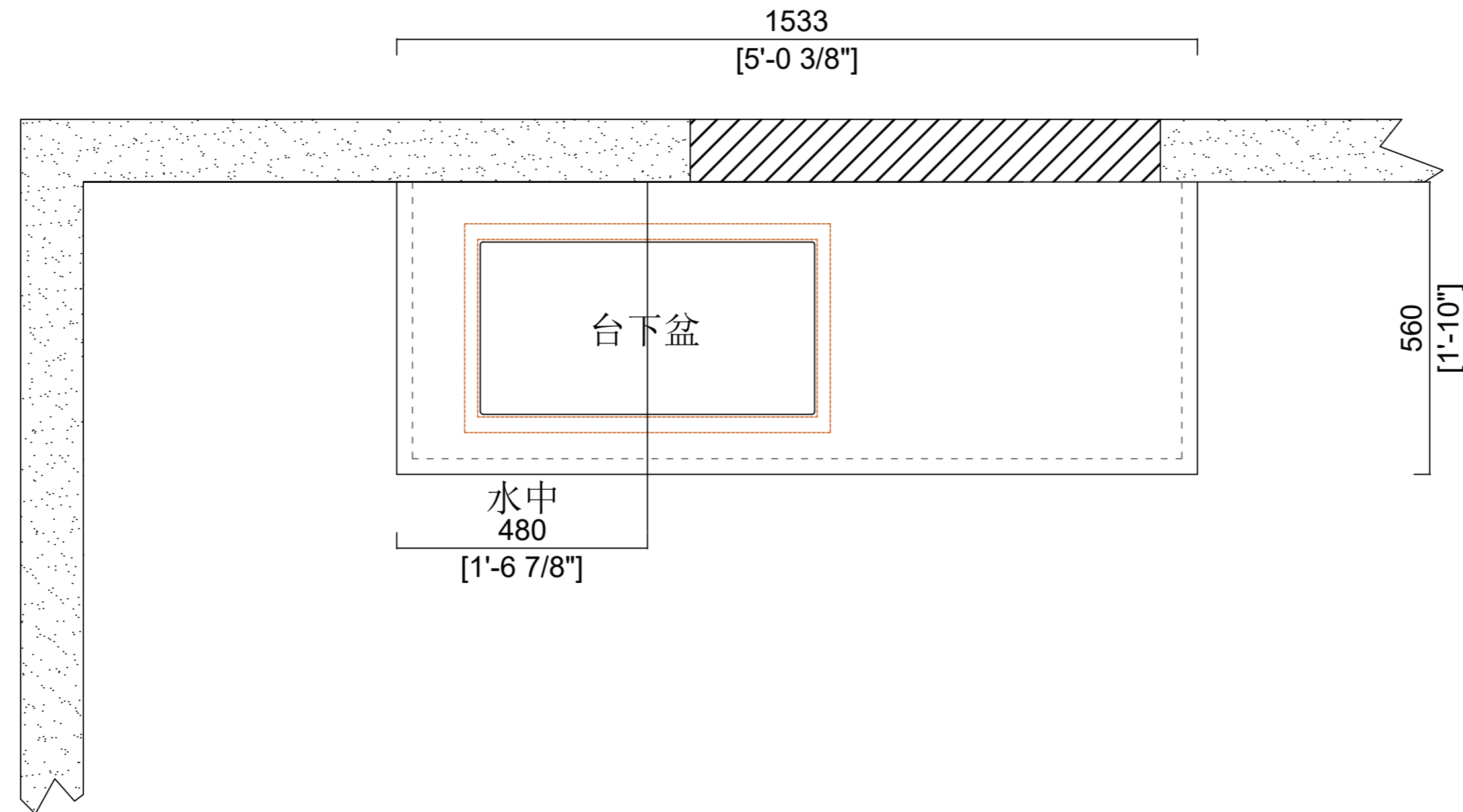

Order No: WMCA240919001

Client Name: Wylie

Email:

Client Address:

Room Space: VANITY 3

Carcass Material	
Door Material	
Door Shape	

Drawer Handle:

Door Handle:

Remark:

Design Date:

Lead Time: 10-12 Weeks

Consignee:

Date:

Designer:

Tel:

# Wet bar

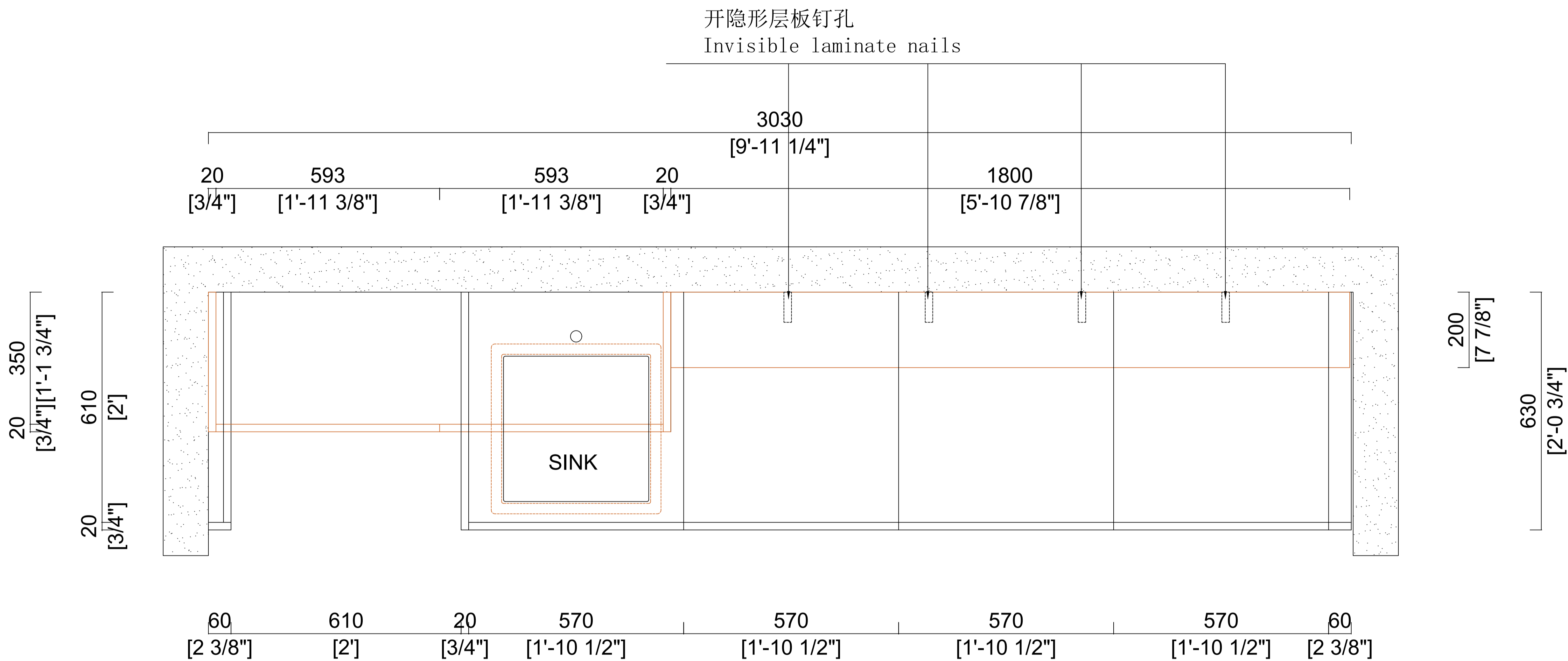

## PLAN

**WAYMOVE**

Order No: WMCA240919001

Client Name: Wylie

Email:

Client Address:

Room Space: WET BAR

Carcass Material	<input checked="" type="checkbox"/>
Door Material	<input type="checkbox"/>
Door Shape	<input checked="" type="checkbox"/>

Drawer Handle:

Door Handle:

Remark:

Design Date:

Lead Time: 10-12 Weeks

Consignee:

Date:

Designer:

Tel:

Pages 1

# Wet bar

20 [3/4"] 593 [1'-11 3/8"] 593 [1'-11 3/8"] 20 [3/4"] 1800 [5'-10 7/8"]

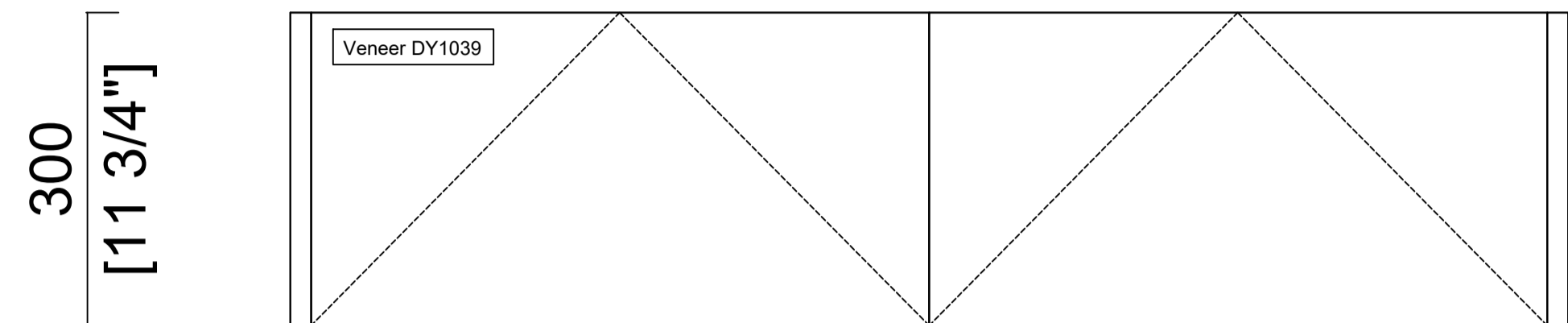

300 [11 3/4"]

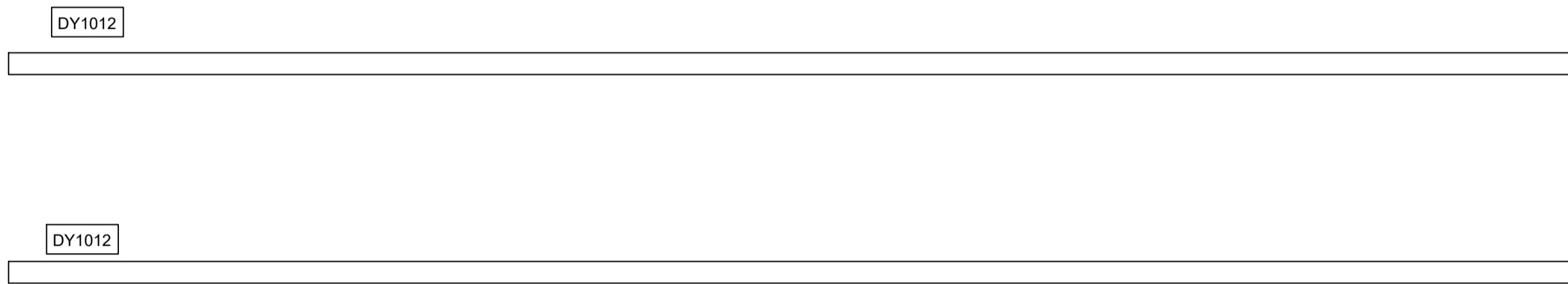

12 [1/2"]  
865 [2'-10"]

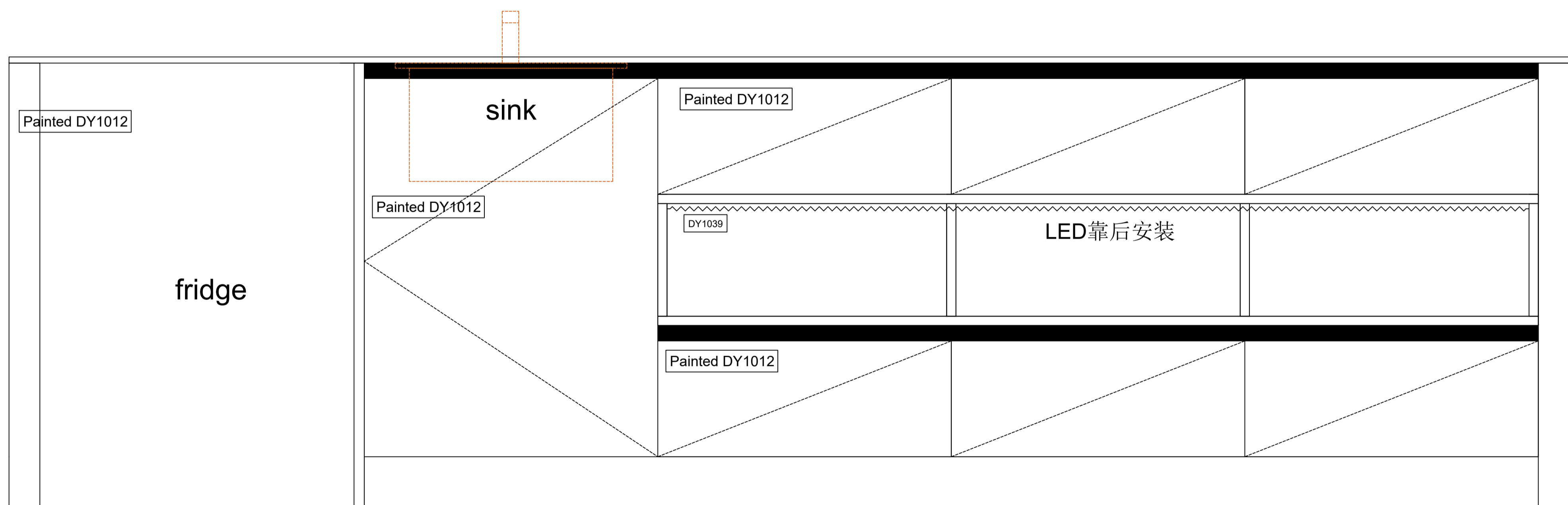

60 [2 3/8"] 610 [2'] 20 [3/4"] 570 [1'-10 1/2"] 570 [1'-10 1/2"] 570 [1'-10 1/2"] 570 [1'-10 1/2"] 60 [2 3/8"]  
3030 [9'-11 1/4"]

215 [8 1/2"]  
215 [8 1/2"]  
255 [10"]  
255 [10"]  
100 [3 7/8"]  
25 [1"]  
25 [1"]  
12 [1/2"]

## ELEVATION

# WAYMOVE

Order No: WMCA240919001

Client Name: Wylie

Email:

Client Address:

Room Space: WET BAR

Carcass Material	<input checked="" type="checkbox"/>
Door Material	<input type="checkbox"/>
Door Shape	<input checked="" type="checkbox"/>

Drawer Handle:

Door Handle:

Remark:

Design Date:

Lead Time: 10-12 Weeks

Consignee:

Date:

Designer:

Tel:

Pages 2

# Wet bar

水槽

外形尺寸: 450\*450mm

开孔尺寸: 395\*395mm

水龙头直径: 26

台下盆

台面型号: 波西尼亚灰12mm

**BOSNIA  
GREY**

波西尼亚灰

DESCRIPTION

非常又深邃的暗白色看到过一抹深沉的灰, 好似大海黄沙的自然风光, 蕴含着不朽又壮丽的美。  
The rich and deep after-white texture crossed a deep grey. Just like the harmonious and quiet natural scenery, it reveals the immortal and magnificent beauty.

SPECIFICATION

DA2M64BK-Y 橱柜台面 1200X2400X12MM	12 MM
<b>DB2M64BR-Y 天然花岗岩</b> <b>1600X3200X12MM</b>	<b>12 MM</b>

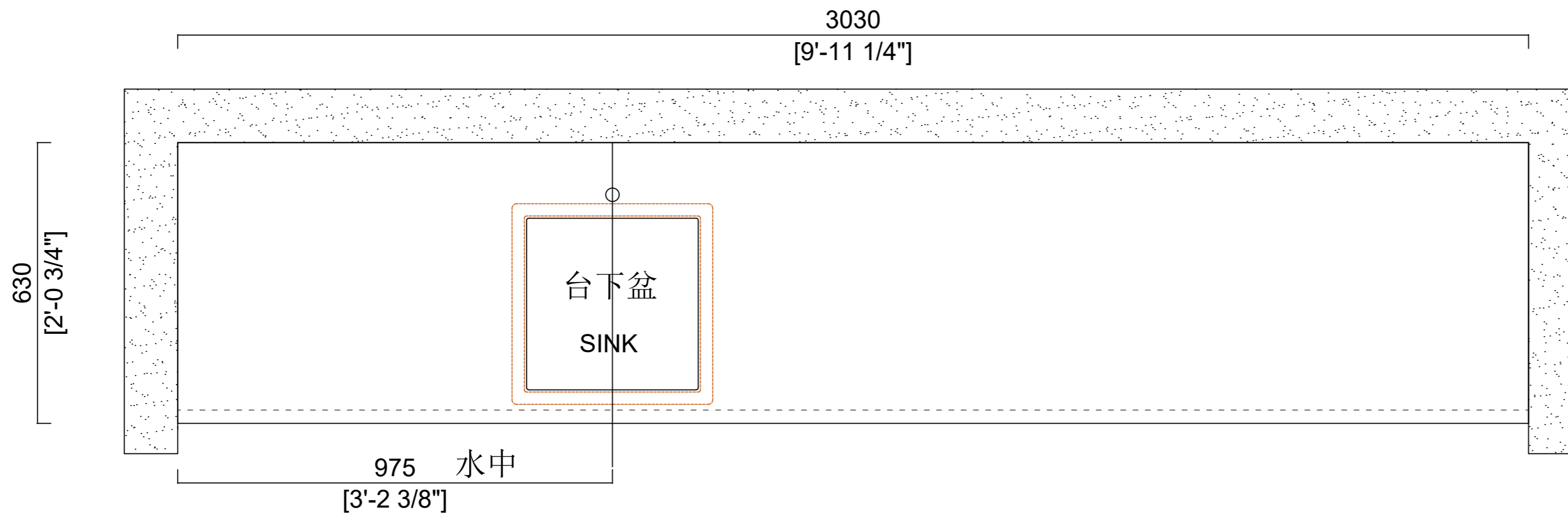

**PLAN**



Order No: WMCA240919001

Client Name: Wylie

Email:

Client Address:

Room Space: WET BAR

Carcass Material	
Door Material	
Door Shape	

Drawer Handle:

Door Handle:

Remark:

Design Date:

Lead Time: 10-12 Weeks

Consignee:  
Date:

Designer:  
Tel:

Pages

Mupry bed

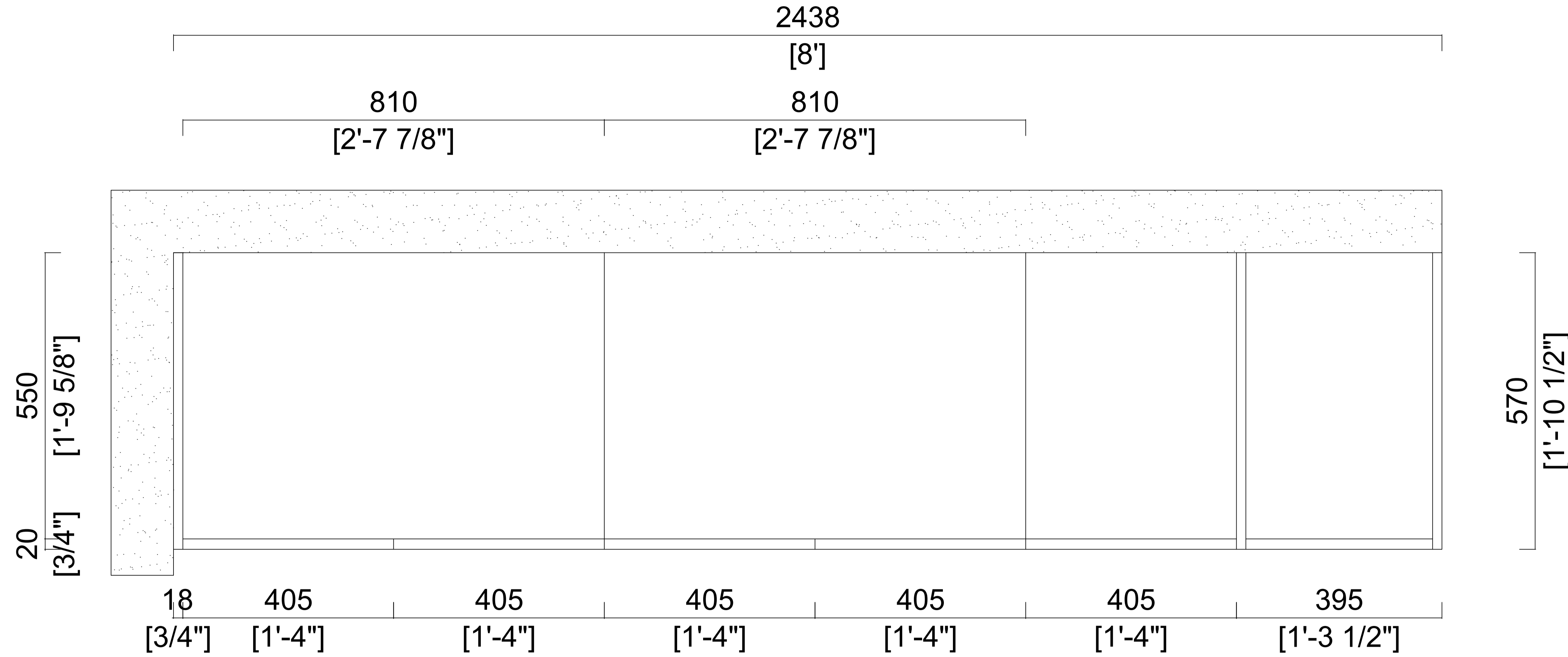

PLAN



Order No: WMCA240919001

Client Name: Wylie

Email:

Client Address:

Room Space: MURPHY BED

Carcass Material	<input checked="" type="checkbox"/>
Door Material	<input checked="" type="checkbox"/>
Door Shape	<input checked="" type="checkbox"/>

Drawer Handle:

Door Handle:

Remark:

Design Date:

Lead Time: 10-12 Weeks

Consignee:

Date:

Designer:

Tel:

Pages	1
-------	---

# Mupry bed

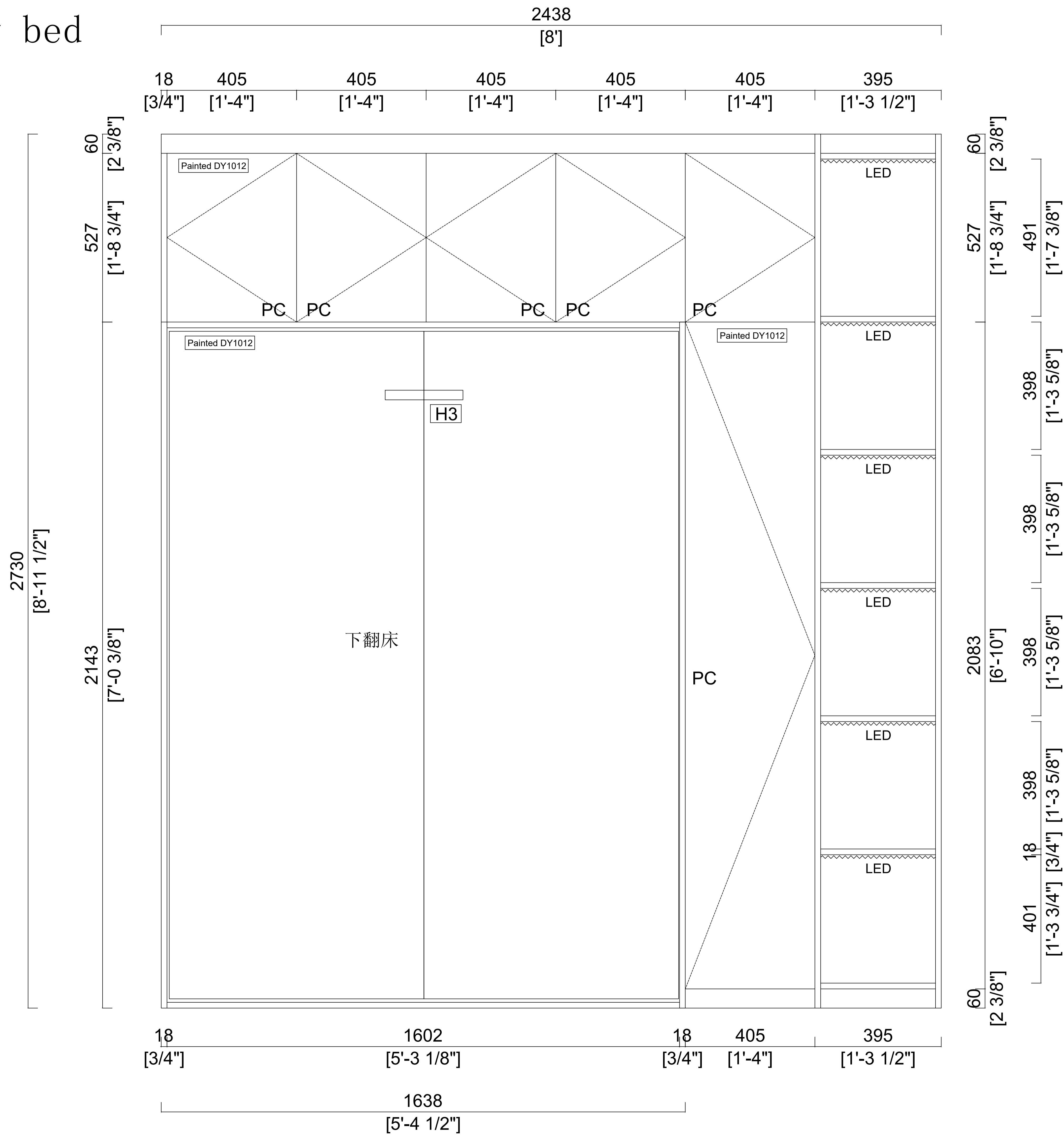

# WAYMOVE

Order No: WMCA240919001

Client Name: Wylie

Email:

Client Address:

Room Space: MURPHY BED

Carcass Material	<input checked="" type="checkbox"/>
Door Material	<input type="checkbox"/>
Door Shape	<input checked="" type="checkbox"/>

Drawer Handle:

Door Handle:

Remark:

Design Date:

Lead Time: 10-12 Weeks

Consignee:

Date:

Designer:

Tel:

# Mupry bed

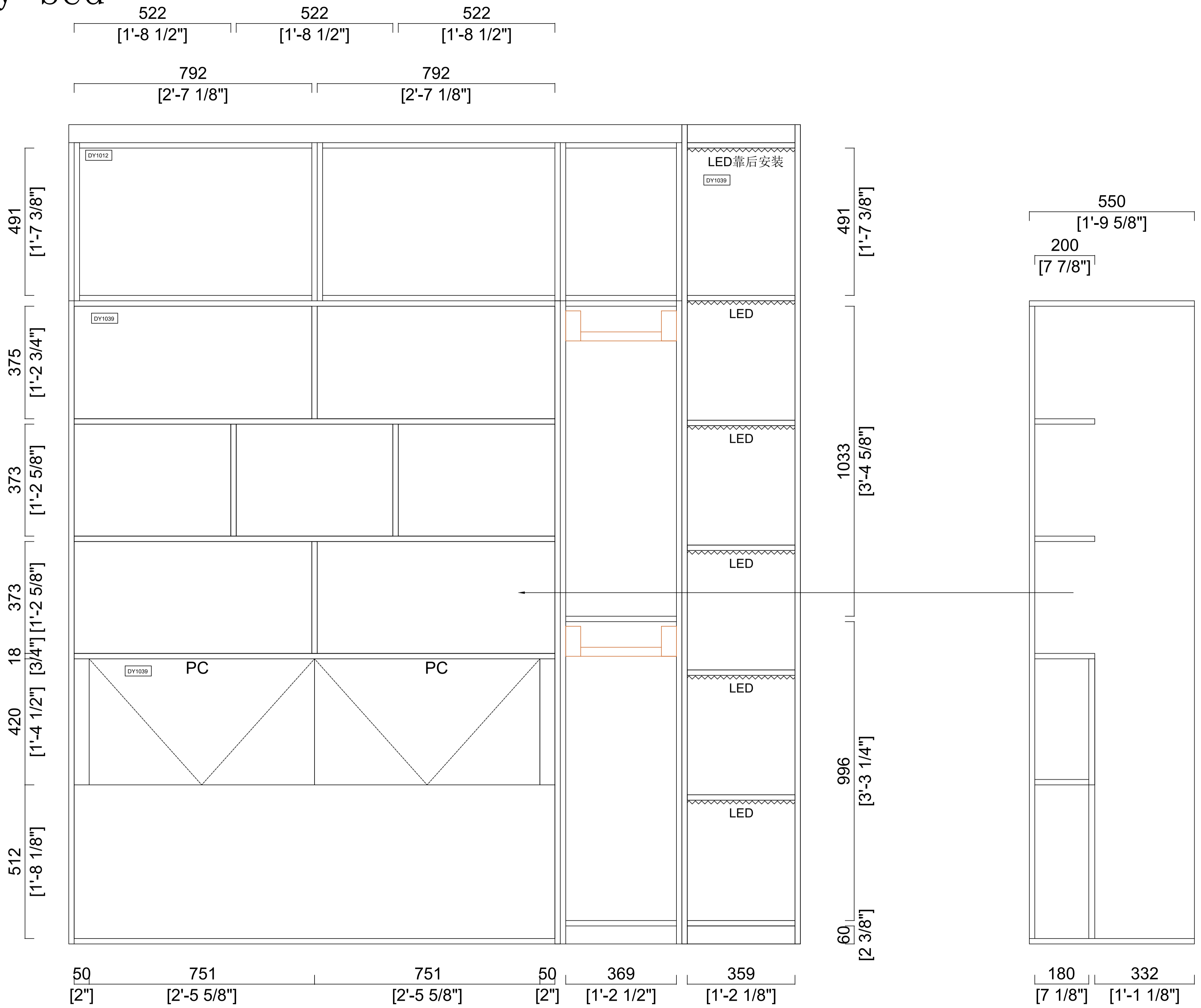

**STRUCTURE**

**SIDE VIEW**



Order No: WMCA240919001

Client Name: Wylie

Email:

Client Address:

Room Space: MURPHY BED

Carcass Material	<input checked="" type="checkbox"/>
Door Material	<input checked="" type="checkbox"/>
Door Shape	<input type="checkbox"/>

Drawer Handle:

Door Handle:

Remark:

Design Date:

Lead Time: 10-12 Weeks

Consignee:

Date:

Designer:

Tel: